



## USER GUIDE

ePMP 1000 | ePMP 2000  
Force 110 | 130 | 180 | 190 | 200  
System Release 3.5.6



## Accuracy

While reasonable efforts have been made to assure the accuracy of this document, Cambium Networks assumes no liability resulting from any inaccuracies or omissions in this document, or from use of the information obtained herein. Cambium reserves the right to make changes to any products described herein to improve reliability, function, or design, and reserves the right to revise this document and to make changes from time to time in content hereof with no obligation to notify any person of revisions or changes. Cambium does not assume any liability arising out of the application or use of any product, software, or circuit described herein; neither does it convey license under its patent rights or the rights of others. It is possible that this publication may contain references to, or information about Cambium products (machines and programs), programming, or services that are not announced in your country. Such references or information must not be construed to mean that Cambium intends to announce such Cambium products, programming or services in your country.

## Copyrights

This document, Cambium products, and 3<sup>rd</sup> Party software products described in this document may include or describe copyrighted Cambium and other 3<sup>rd</sup> Party supplied computer programs stored in semiconductor memories or other media. Laws in the United States and other countries preserve for Cambium, its licensors, and other 3<sup>rd</sup> Party supplied software certain exclusive rights for copyrighted material, including the exclusive right to copy, reproduce in any form, distribute and make derivative works of the copyrighted material. Accordingly, any copyrighted material of Cambium, its licensors, or the 3<sup>rd</sup> Party software supplied material contained in the Cambium products described in this document may not be copied, reproduced, reverse engineered, distributed, merged or modified in any manner without the express written permission of Cambium. Furthermore, the purchase of Cambium products shall not be deemed to grant either directly or by implication, estoppel, or otherwise, any license under the copyrights, patents or patent applications of Cambium or other 3<sup>rd</sup> Party supplied software, except for the normal non-exclusive, royalty free license to use that arises by operation of law in the sale of a product.

## Restrictions

Software and documentation are copyrighted materials. Making unauthorized copies is prohibited by law. No part of the software or documentation may be reproduced, transmitted, transcribed, stored in a retrieval system, or translated into any language or computer language, in any form or by any means, without prior written permission of Cambium.

## License Agreements

The software described in this document is the property of Cambium and its licensors. It is furnished by express license agreement only and may be used only in accordance with the terms of such an agreement.

## High Risk Materials

Cambium and its supplier(s) specifically disclaim any express or implied warranty of fitness for any high risk activities or uses of its products including, but not limited to, the operation of nuclear facilities, aircraft navigation or aircraft communication systems, air traffic control, life support, or weapons systems ("High Risk Use"). Any High Risk is unauthorized, is made at your own risk and you shall be responsible for any and all losses, damage or claims arising out of any High Risk Use.

© 2019 Cambium Networks Limited. All Rights Reserved.

## Safety and regulatory information

This section describes important safety and regulatory guidelines that must be observed by personnel installing or operating ePMP equipment.

### IMPORTANT SAFETY INFORMATION

---



Warning: To prevent loss of life or physical injury, observe the safety guidelines in this section.

#### ***Power lines***

Exercise extreme care when working near power lines.

#### ***Working at heights***

Exercise extreme care when working at heights.

#### ***Grounding and protective earth***

Connectorized ePMP devices must be properly grounded to protect against lightning. It is the user's responsibility to install the equipment in accordance with national regulations. In the USA, follow Section 810 of the *National Electric Code, ANSI/NFPA No.70-1984* (USA). In Canada, follow Section 54 of the *Canadian Electrical Code*. These codes describe correct installation procedures for grounding the outdoor unit, mast, lead-in wire and discharge unit, size of grounding conductors and connection requirements for grounding electrodes. Other regulations may apply in different countries and therefore it is recommended that installation be contracted to a professional installer.

#### ***Powering down before servicing***

Always power down and unplug the equipment before servicing.

#### ***Primary disconnect device***

The ePMP power supply is the primary disconnect device.

#### ***External cables***

Safety may be compromised if outdoor rated cables are not used for connections that will be exposed to the outdoor environment.

#### ***RF exposure near the antenna***

Strong radio frequency (RF) fields will be present close to the antenna when the transmitter is on. Always turn off the power to the ePMP device before undertaking maintenance activities in front of the antenna.

#### ***Minimum separation distances***

Install the ePMP device so as to provide and maintain the minimum separation distances from all persons.

The minimum separation distances for each frequency variant are specified in **Calculated distances and power compliance margins** on page 430.

### IMPORTANT REGULATORY INFORMATION

The ePMP product is certified as an unlicensed device in frequency bands where it is not allowed to cause interference to licensed services (called primary users of the bands).

This device complies with part 15 of the FCC Rules. Operation is subject to the following two conditions: (1) This device may not cause harmful interference, and (2) this device must accept any interference received, including interference that may cause undesired operation.

### ***Radar avoidance***

In countries where radar systems are the primary band users, the regulators have mandated special requirements to protect these systems from interference caused by unlicensed devices. Unlicensed devices must detect and avoid co-channel operation with radar systems.

The ePMP provides detect and avoid functionality for countries and frequency bands requiring protection for radar systems.

Installers and users must meet all local regulatory requirements for radar detection. To meet these requirements, users must set the correct country code during commissioning of the ePMP equipment. If this is not done, installers and users may be liable to civil and criminal penalties.

Contact the Cambium helpdesk if more guidance is required.

### ***USA and Canada specific information***

The USA Federal Communications Commission (FCC) has asked manufacturers to implement special features to prevent interference to weather radar systems that operate in the band 5600 MHz to 5650 MHz. These features must be implemented in all products able to operate outdoors in the band 5470 MHz to 5725 MHz.

Manufacturers must ensure that such radio products cannot be configured to operate outside of FCC rules; specifically it must not be possible to disable or modify the radar protection functions that have been demonstrated to the FCC.

In order to comply with these FCC requirements, Cambium supplies variants of the ePMP for operation in the USA or Canada. These variants are only allowed to operate with license keys and country codes that comply with FCC/IC rules. In particular, operation of radio channels overlapping the band 5600-5650 MHz is not allowed and these channels are permanently barred.

In addition, other channels may also need to be barred when operating close to weather radar installations.



#### **Note**

To ensure compliance with FCC rules (KDB 443999: Interim Plans to Approve UNII Devices Operating in the 5470 - 5725 MHz Band with Radar Detection and DFS Capabilities), follow **Avoidance of weather radars** on page **101**.

**Note**

When using an ePMP 1000 Integrated Radio or ePMP 1000 Connectorized Radio (non-GPS) in the 5.8 GHz band configured with:

- Radio Mode set to Access Point

and

- Channel Bandwidth set to 20 MHz or 40 MHz

the maximum **Transmitter Output Power** must be reduced by 3 dB to comply with FCC / ISEDC emission requirements.

**Note**

When using a Force 200 radio with **Channel Bandwidth** set to **20 MHz** in the 5.8 GHz band, the lowest allowable **Frequency Carrier** is 5740 MHz and the highest allowable **Frequency Carrier** is 5835 MHz.

When using a Force 180 radio with **Channel Bandwidth** set to **20 MHz** or **40 MHz** in the 5.8 GHz band, the maximum **Transmitter Output Power** must be reduced by 3 dB to comply with FCC / ISEDC emission requirements.

When using a Force 180 radio with **Channel Bandwidth** set to **20 MHz** in the 5.8 GHz band, the lowest allowable **Frequency Carrier** is 5740 MHz and the highest allowable **Frequency Carrier** is 5835 MHz.

Other variants of the ePMP are available for use in the rest of the world, but these variants are not supplied to the USA or Canada except under strict controls, when they are needed for export and installation outside the USA or Canada.

### ***Specific expertise and training required for professional installers***

To ensure that the ePMP is installed and configured in compliance with the requirements of Industry Canada and the FCC, installers must have the radio engineering skills and training described in this section. This is particularly important when installing and configuring an ePMP system for operation in the 5 GHz band (5150 – 5250 MHz – FCC only, 5250 – 5350 MHz, 5470 – 5725 MHz and 5725 – 5850 MHz).

### ***Avoidance of weather radars***

The installer must be familiar with the requirements in FCC KDB 443999. Essentially, the installer must be able to:

- Access the FCC database of weather radar location and channel frequencies.
- Use this information to correctly configure the product (using the GUI) to avoid operation on channels that must be avoided according to the guidelines that are contained in the KDB and explained in detail in this user guide.
- In ETSI regions, the band 5600 MHz to 5650 MHz is reserved for the use of weather radars.

### ***External antennas***

When using a connectorized version of the product (as compared to the version with an integrated antenna), the conducted transmit power must be reduced to ensure the regulatory limit on transmitter EIRP is not exceeded. The installer must have an understanding of how to compute the effective antenna gain from the actual antenna gain and the antenna cable losses.

The product GUI automatically applies the correct conducted power limit to ensure that it is not possible for the installation to exceed the EIRP limit, when the appropriate values for antenna gain are entered into the GUI.

***Ethernet networking skills***

The installer must have the ability to configure IP addressing on a PC and to set up and control products using a web browser interface.

***Lightning protection***

To protect outdoor radio installations from the impact of lightning strikes, the installer must be familiar with the normal procedures for site selection, bonding and grounding. Installation guidelines for the ePMP can be found in section **Surge suppression unit** on page **97**.

***Training***

The installer needs to have basic competence in radio and IP network installation. The specific requirements applicable to the ePMP must be gained by reading this user guide and by performing sample setups at base workshop before live installations.

**FURTHER READING**

Please refer to section **Installation and Safety** on page **32** for more information.

## Contents

<b>Safety and regulatory information .....</b>	<b>3</b>
Important safety information.....	3
Important regulatory information.....	3
Further Reading.....	6
<b>Contents .....</b>	<b>7</b>
<b>About This User Guide .....</b>	<b>12</b>
<b>General information .....</b>	<b>13</b>
Version information .....	13
Contacting Cambium Networks.....	14
<b>Problems and warranty .....</b>	<b>16</b>
<b>Security advice .....</b>	<b>17</b>
<b>Warnings, cautions, and notes.....</b>	<b>18</b>
<b>Caring for the environment.....</b>	<b>19</b>
<b>Product description.....</b>	<b>20</b>
<b>Overview of ePMP.....</b>	<b>21</b>
Purpose .....	21
Key features .....	21
Typical installation Equipment .....	22
<b>Wireless operation .....</b>	<b>24</b>
Time division duplexing.....	24
OFDM and channel bandwidth .....	24
Adaptive modulation.....	24
MIMO .....	24
Radar avoidance.....	24
Encryption .....	25
Country codes .....	25
Smart Beamforming (ePMP 2000 series) .....	25
PMP networks.....	26
Further reading on wireless operation.....	27
<b>System management .....</b>	<b>28</b>
Management agent.....	28
Web server .....	28
SNMP.....	30
Network Time Protocol (NTP) .....	30
cnMaestro™ .....	30
Software upgrade.....	30
Further reading on system management.....	30
<b>System hardware .....</b>	<b>31</b>
<b>Installation and Safety.....</b>	<b>32</b>
Site installation.....	32
Grounding and lightning protection.....	32
Lightning protection zones.....	33
<b>ePMP 2000 .....</b>	<b>35</b>
<b>ePMP 2000 Access Point with Intelligent Filtering and Sync.....</b>	<b>35</b>
ePMP 2000 Access Point with Intelligent Filtering and Sync description .....	35
ePMP 2000 Access Point with Intelligent Filtering and Sync part numbers .....	36
ePMP 2000 Access Point with Intelligent Filtering and Sync mounting bracket .....	37
ePMP 2000 Access Point with Intelligent Filtering and Sync interfaces .....	38
ePMP 2000 Access Point with Intelligent Filtering and Sync LEDs .....	38
ePMP 2000 Access Point with Intelligent Filtering and Sync specifications .....	39
ePMP 2000 Access Point with Intelligent Filtering and Sync heater .....	41
ePMP 2000 Access Point with Intelligent Filtering and Sync - external antenna location.....	41

ePMP 2000 Access Point with Intelligent Filtering and Sync wind loading ..... 41

ePMP 2000 Access Point with Intelligent Filtering and Sync software packages ..... 42

ePMP 2000 Access Point with Intelligent Filtering and Sync, antennas and antenna cabling..... 42

Antenna requirements ..... 43

FCC and IC approved antennas..... 43

**ePMP 1000 ..... 44**

**ePMP 1000 Connectorized Radio with Sync.....44**

        ePMP 1000 Connectorized Radio with Sync description ..... 44

        ePMP 1000 Connectorized Radio with Sync part numbers ..... 44

        ePMP 1000 Connectorized Radio with Sync mounting bracket ..... 45

        ePMP 1000 Connectorized Radio with Sync interfaces ..... 46

        ePMP 1000 Connectorized Radio with Sync LEDs ..... 47

        ePMP 1000 Connectorized Radio with Sync specifications ..... 47

        ePMP 1000 Connectorized Radio with Sync heater ..... 49

        ePMP 1000 Connectorized Radio with Sync and external antenna location..... 49

        ePMP 1000 Connectorized Radio with Sync wind loading ..... 49

        ePMP 1000 Connectorized Radio with Sync software packages ..... 50

        ePMP 1000 Connectorized Radio with Sync, antennas and antenna cabling..... 50

        ePMP 1000 Antenna requirements..... 51

        ePMP 1000 FCC and IC approved antennas ..... 51

**ePMP 1000 Integrated Radio .....52**

        ePMP 1000 Integrated Radio description ..... 52

        ePMP 1000 Integrated Radio part numbers..... 52

        ePMP 1000 Integrated Radio mounting bracket..... 53

        ePMP 1000 Integrated Radio interfaces..... 53

        ePMP 1000 Integrated Radio LEDs..... 54

        ePMP 1000 Integrated Radio specifications..... 54

        ePMP 1000 Integrated Radio heater ..... 55

        ePMP 1000 Integrated Radio wind loading ..... 55

        ePMP 1000 Integrated Radio software packages..... 56

**ePMP 1000 Connectorized Radio .....57**

        ePMP 1000 Connectorized Radio description ..... 57

        ePMP 1000 Connectorized Radio part numbers ..... 57

        ePMP 1000 Connectorized Radio mounting bracket..... 58

        ePMP 1000 Connectorized Radio Interfaces ..... 59

        ePMP 1000 Connectorized Radio LEDs..... 59

        ePMP 1000 Connectorized Radio specifications ..... 60

        ePMP 1000 Connectorized Radio heater ..... 62

        ePMP 1000 Connectorized Radio and external antenna location ..... 62

        ePMP 1000 Connectorized Radio wind loading..... 62

        Connectorized Radio software packages..... 63

        ePMP 1000 Connectorized Radio antennas and antenna cabling..... 63

        ePMP 1000 Antenna requirements..... 64

        ePMP 1000 FCC and IC approved antennas ..... 64

**Force 130.....65**

        Force 130 description ..... 65

        Force 130 part numbers..... 65

        Force 130 mounting ..... 66

        Force 130 interfaces..... 67

        Force 130 LEDs ..... 68

        Force 130 specifications ..... 68

        Force 130 software packages ..... 69

**Force 180.....70**

        Force 180 description ..... 70

        Force 180 part numbers..... 70

        Force 180 mounting bracket ..... 71

        Force 180 interfaces..... 71



Force 180 LEDs .....	72
Force 180 specifications .....	72
Force 180 heater .....	73
Force 180 wind loading .....	73
Force 180 software packages .....	74
<b>Force 190.....</b>	<b>75</b>
Force 190 description .....	75
Force 190 part numbers .....	75
Force 190 mounting bracket .....	77
Force 190 interfaces.....	77
Force 190 LEDs .....	79
Force 190 specifications .....	79
Force 190 heater .....	80
Force 190 wind loading .....	80
Force 190 software packages .....	81
<b>Force 200.....</b>	<b>82</b>
Force 200 description .....	82
Force 200 part numbers.....	83
Force 200 mounting bracket .....	84
Force 200 interfaces.....	84
Force 200 LEDs .....	86
Force 200 specifications .....	86
Force 200 heater .....	87
Force 200 wind loading .....	87
Force 200 software packages .....	88
<b>ePMP 2000 Series Power Supply .....</b>	<b>89</b>
Power supply description .....	89
Power supply part numbers .....	89
Power supply interfaces .....	90
Power supply specifications .....	90
Power supply location .....	91
<b>ePMP 1000 Series Power Supply (includes Force 180, Force 190, and Force 200) .....</b>	<b>92</b>
Power supply description .....	92
Power supply part numbers .....	92
Power supply interfaces .....	93
Power supply specifications .....	94
Power supply location .....	94
<b>Ethernet cabling .....</b>	<b>95</b>
Ethernet standards and cable lengths.....	95
Outdoor Cat5e cable .....	95
<b>Surge suppression unit .....</b>	<b>97</b>
Gigabit Ethernet Surge Suppressor .....	97
<b>System planning .....</b>	<b>98</b>
<b>Radio spectrum planning .....</b>	<b>99</b>
General wireless specifications .....	99
Regulatory limits .....	100
Conforming to the limits .....	100
Available spectrum.....	100
Channel bandwidth .....	101
Avoidance of weather radars .....	101
<b>Link planning .....</b>	<b>103</b>
Range and obstacles.....	103
Path loss .....	103
Adaptive modulation.....	103
<b>Planning for connectorized units.....</b>	<b>104</b>
Calculating maximum power level for connectorized units .....	104
<b>Data network planning .....</b>	<b>106</b>

Ethernet interfaces.....	106
Management VLAN .....	107
Quality of service for bridged Ethernet traffic .....	107
<b>Configuration.....</b>	<b>108</b>
<b>Preparing for configuration.....</b>	<b>109</b>
Safety precautions.....	109
Regulatory compliance.....	109
<b>Connecting to the unit .....</b>	<b>110</b>
Configuring the management PC .....	110
Connecting to the PC and powering up.....	111
<b>Using the web interface.....</b>	<b>112</b>
Logging into the web interface.....	113
Layout of the web interface .....	113
<b>ePMP Device Configuration Parameters - Default Values .....</b>	<b>122</b>
<b>Configuring connectorized radios using the Quick Start menu .....</b>	<b>125</b>
<b>Configuring SM units using the Quick Start menu .....</b>	<b>128</b>
<b>Using the AP menu options.....</b>	<b>132</b>
AP Configure menu .....	133
AP Monitor menu.....	161
AP Tools menu .....	180
<b>Using the SM menu options .....</b>	<b>200</b>
SM Configuration menu .....	201
SM Monitor menu .....	246
SM Tools menu.....	267
<b>Radius Server .....</b>	<b>281</b>
Installing Free-radius on Ubuntu 12.04 LTS.....	281
Configuring Free-radius server .....	281
Configuring radius parameters on AP .....	283
Configuring radius parameters on SM.....	284
Configuring MIR profiles.....	285
Creating certificate for Radius server and SM device.....	286
Vendor-Specific Attribute (VSA) Reference .....	290
<b>Operation and Troubleshooting .....</b>	<b>294</b>
<b>General Planning for Troubleshooting.....</b>	<b>295</b>
General Fault Isolation Process .....	295
Questions to Help Isolate the Problem .....	296
<b>Upgrading device software .....</b>	<b>297</b>
<b>Upgrading on-board GPS chip firmware .....</b>	<b>298</b>
GPS Chip and Software Reference .....	299
<b>Testing hardware.....</b>	<b>300</b>
Checking the power supply LED .....	300
Power LED is off .....	300
Ethernet LED is off.....	300
<b>Troubleshooting the radio link.....</b>	<b>302</b>
Module has lost or does not establish radio connectivity.....	302
Link is unreliable or does not achieve data rates required .....	302
Module Has Lost or Does Not Gain GPS Synchronization .....	303
<b>Using the device external reset button.....</b>	<b>304</b>
<b>Resetting ePMP to factory defaults by power cycling .....</b>	<b>306</b>
<b>Recovery of flash-corrupted ePMP devices .....</b>	<b>307</b>
<b>Flexible License Generation Procedure.....</b>	<b>308</b>
<b>Enabling AP Flexible License Management.....</b>	<b>312</b>
<b>Legal and reference information .....</b>	<b>313</b>
<b>Cambium Networks end user license agreement.....</b>	<b>314</b>

Acceptance of this agreement .....	314
Definitions .....	314
Grant of license .....	314
Conditions of use.....	314
Title and restrictions .....	315
Confidentiality .....	315
Right to use Cambium’s name.....	315
Transfer .....	316
Updates .....	316
Maintenance .....	316
Disclaimer.....	316
Limitation of liability.....	316
U.S. government.....	317
Term of license .....	317
Governing law .....	317
Assignment.....	317
Survival of provisions .....	317
Entire agreement .....	317
Third party software.....	317
Source Code Requests.....	318
Preamble .....	335
TERMS AND CONDITIONS FOR COPYING, DISTRIBUTION AND MODIFICATION .....	336
END OF TERMS AND CONDITIONS .....	340
<b>Hardware warranty .....</b>	<b>424</b>
<b>Limit of liability .....</b>	<b>425</b>
<b>System threshold, output power and link loss.....</b>	<b>426</b>
<b>Dynamic transmitter output power.....</b>	<b>427</b>
<b>Compliance with safety standards .....</b>	<b>428</b>
Electrical safety compliance .....	428
Electromagnetic compatibility (EMC) compliance .....	428
Human exposure to radio frequency energy.....	428
<b>Compliance with radio regulations.....</b>	<b>444</b>
Type approvals .....	444
FCC and ETSI compliance testing.....	444
Examples of regulatory limits .....	447
<b>Notifications.....</b>	<b>466</b>
2.4 GHz, 5.4 GHz regulatory compliance .....	466
5.8 GHz regulatory compliance .....	472
Thailand notification .....	476
<b>Data throughput tables.....</b>	<b>477</b>
Data throughput capacity.....	477
<b>Radio Specifications.....</b>	<b>480</b>
ePMP 2000 Product Specifications.....	480
ePMP 1000 Product Specifications.....	480
<b>Glossary .....</b>	<b>481</b>

## About This User Guide

This guide describes the planning, installation, configuration and operation of the Cambium ePMP Series of point-to-multipoint wireless Ethernet systems. It is intended for use by the system designer, system installer and system administrator.

For radio network design, see:

- [Product description](#)
- [System hardware](#)
- [System planning](#)
- [Legal and reference information](#)

For system configuration, monitoring and fault finding, see:

- [Configuration](#)
- [Operation and Troubleshooting](#)

## General information

### VERSION INFORMATION

The following shows the issue status of this document:

Issue	Date of issue	Remarks
001v000	October 2013	System Release 1.0 (Software Release 1.1.6)
002v000	December 2013	System Release 1.0 (Software Release 1.2.3)
003v000	January 2014	System Release 1.0 (Software Release 1.3.4)
004v000	March 2014	System Release 1.0 (Software Release 1.4.1)
005v000	March 2014	System Release 1.0 (Software Release 1.4.3)
006v000	April 2014	System Release 1.0 (Software Release 1.4.4)
007v000	June 2014	System Release 2.0 (Software Release 2.0)
008v000	July 2014	System Release 2.1 (Software Release 2.1)
010v000	September 2014	System Release 2.2 (Software Release 2.2)
011v000	October 2014	System Release 2.3 (Software Release 2.3)
012v000	November 2014	System Release 2.3.1 (Software Release 2.3.1)
013v000	December 2014	System Release 2.3.3 (Software Release 2.3.3)
014v000	December 2014	System Release 2.3.4 (Software Release 2.3.4)
015v000	March 2015	System Release 2.4 (Software Release 2.4)
016v000	April 2015	System Release 2.4.1 (Software Release 2.4.1) System Release 2.4.2 (Software Release 2.4.2)
017v000	June 2015	System Release 2.4.3 (Software Release 2.4.3)
018v000	August 2015	System Release 2.5 (Software Release 2.5)
019v000	October 2015	System Release 2.5.1 (Software Release 2.5.1)
020v000	November 2015	System Release 2.5.2 (Software Release 2.5.2)
021v000	December 2015	System Release 2.6 (Software Release 2.6)
022v000	February 2016	System Release 2.6.1 (Software Release 2.6.1)
023v000	June 2016	System Release 2.6.2 (Software Release 2.6.2)
024v000	June 2016	System Release 3.0 (Software Release 3.0)
025v000	September 2016	System Release 3.0.1 (Software Release 3.0.1)
025v007	November 2016	System Release 3.1 (Software Release 3.1) System Release 3.2 (Software Release 3.2)
025v008	December 2016	System Release 3.2.1 (Software Release 3.2.1)

---

025v009	January 2017	
025v010		
025v011	January 2017	System Release 3.2.2 (Software Release 3.2.2)
026v007	March 2017 April 2017	System Release 3.3 (Software Release 3.3)
026v012	June 2017	System Release 3.4.1 (Software Release 3.4.1)
026v018	August 2017	System Release 3.5 (Software Release 3.5)
026v020	December 2017	System Release 3.5.1 (Software Release 3.5.1)
026v030	July 2018	System Release 3.5.2 (Software Release 3.5.2)
026v031	January 2019	System Release 3.5.5 (Software Release 3.5.5)
026v033	June 2019	System Release 3.5.6 (Software Release 3.5.6)

---

## CONTACTING CAMBIUM NETWORKS

Support website: <https://support.cambiumnetworks.com>  
Main website: <http://www.cambiumnetworks.com>  
Sales enquiries: [solutions@cambiumnetworks.com](mailto:solutions@cambiumnetworks.com)

Address: Cambium Networks Limited,  
3800 Golf Road, Suite 360  
Rolling Meadows, IL 60008

## Purpose

Cambium Networks ePMP documents are intended to instruct and assist personnel in the operation, installation and maintenance of the Cambium ePMP equipment and ancillary devices. It is recommended that all personnel engaged in such activities be properly trained.

Cambium disclaims all liability whatsoever, implied or expressed, for any risk of damage, loss or reduction in system performance arising directly or indirectly out of the failure of the customer, or anyone acting on the customer's behalf, to abide by the instructions, system parameters, or recommendations made in this document.

## Cross references

References to external publications are shown in *italics*. Other cross references, emphasized in **green text** in electronic versions, are active links to the references.

## Feedback

We appreciate feedback from the users of our documents. This includes feedback on the structure, content, accuracy, or completeness of our documents.

For feedback, go to <https://support.cambiumnetworks.com>.

## Problems and warranty

### Reporting problems

If any problems are encountered when installing or operating this equipment, follow this procedure to investigate and report:

- 1 Search this document and the software release notes of supported releases.
- 2 Visit the support website:  
<https://support.cambiumnetworks.com/>
- 3 Ask for assistance from the Cambium product supplier.
- 4 Gather information from affected units, such as any available diagnostic downloads.
- 5 Escalate the problem by emailing or telephoning support:  
<http://www.cambiumnetworks.com/support/contact-support>

### Repair and service

If unit failure is suspected, obtain details of the Return Material Authorization (RMA) process from the support website.

### Warranty

Cambium's standard hardware warranty is for one (1) year from date of shipment from Cambium or a Cambium distributor. Cambium warrants that hardware will conform to the relevant published specifications and will be free from material defects in material and workmanship under normal use and service. Cambium shall within this time, at its own option, either repair or replace the defective product within thirty (30) days of receipt of the defective product. Repaired or replaced product will be subject to the original warranty period but not less than thirty (30) days.

To register PMP products or activate warranties, visit the support website.

For warranty assistance, contact the reseller or distributor.



Caution

Do not open the radio housing for repair or diagnostics; there are no serviceable parts within the housing.

Portions of Cambium equipment may be damaged from exposure to electrostatic discharge. Use precautions to prevent damage.



## Security advice

Cambium Networks systems and equipment provide security parameters that can be configured by the operator based on their particular operating environment. Cambium recommends setting and using these parameters following industry recognized security practices. Security aspects to be considered are protecting the confidentiality, integrity, and availability of information and assets. Assets include the ability to communicate, information about the nature of the communications, and information about the parties involved.

In certain instances Cambium makes specific recommendations regarding security practices, however the implementation of these recommendations and final responsibility for the security of the system lies with the operator of the system.

Cambium Networks ePMP equipment is shipped with default web management interface login credentials. It is highly recommended that these usernames and passwords are modified prior to system installation.

## Warnings, cautions, and notes

The following describes how warnings and cautions are used in this document and in all documents of the Cambium Networks document set.

### Warnings

Warnings precede instructions that contain potentially hazardous situations. Warnings are used to alert the reader to possible hazards that could cause loss of life or physical injury. A warning has the following format:



Warning

Warning text and consequence for not following the instructions in the warning.

### Cautions

Cautions precede instructions and are used when there is a possibility of damage to systems, software, or individual items of equipment within a system. However, this damage presents no danger to personnel. A caution has the following format:



Caution

Caution text and consequence for not following the instructions in the caution.

### Notes

A note means that there is a possibility of an undesirable situation or provides additional information to help the reader understand a topic or concept. A note has the following format:



Note

Note text

## Caring for the environment

The following information describes national or regional requirements for the disposal of Cambium Networks supplied equipment and for the approved disposal of surplus packaging.

### In EU countries

The following information is provided to enable regulatory compliance with the European Union (EU) directives identified and any amendments made to these directives when using Cambium equipment in EU countries.



#### ***Disposal of Cambium equipment***

European Union (EU) Directive 2002/96/EC Waste Electrical and Electronic Equipment (WEEE)

Do not dispose of Cambium equipment in landfill sites. For disposal instructions, see

<https://support.cambiumnetworks.com>

#### ***Disposal of surplus packaging***

Do not dispose of surplus packaging in landfill sites. In the EU, it is the individual recipient's responsibility to ensure that packaging materials are collected and recycled according to the requirements of EU environmental law.

### In non-EU countries

In non-EU countries, dispose of Cambium equipment and all surplus packaging in accordance with national and regional regulations.

## Product description

This chapter provides a high level description of the ePMP product. It describes the function of the product, the main product variants and typical installation. It also describes the main hardware components.

The following topics are described in this chapter:

- The key features, typical uses, product variants and components of the ePMP are explained in **Overview of ePMP** on page **21**.
- How the ePMP wireless link is operated, including modulation modes, power control and security is described under **Wireless operation** on page **24**.
- The ePMP management system, including the web interface, installation, configuration, alerts and upgrades is described in **System management** on page **28**.

## Overview of ePMP

This section introduces the key features, typical uses, product variants and components of the ePMP.

### PURPOSE

Cambium ePMP Series products are designed for Ethernet bridging over point-to-multipoint microwave links in the unlicensed 2.4 GHz, 2.5 GHz (Brazil only), 5 GHz and 6.4 GHz bands. Users must ensure that the ePMP Series complies with local operating regulations.

The ePMP Series acts as a transparent bridge between two segments of the operator and customers' networks. In this sense, it can be treated as a virtual wired connection between the Access Point and the Subscriber Module. The ePMP Series forwards 802.3 Ethernet packets destined for the other part of the network and filters packets it does not need to forward.

### KEY FEATURES

The ePMP system is a high performance wireless bridge for Ethernet traffic with a maximum UDP throughput of 200+ Mbps (40 MHz Channel Bandwidth). It is capable of operating in line-of-sight (LOS) and near-LOS conditions. Its maximum LOS range is 13 mi (20 MHz channel bandwidth) or 9 mi (40 MHz channel bandwidth).

Utilizing GPS sync, the ePMP is an ideal fit for networks that require capacity and reliability for superior QoS in remote and underserved areas. The integrated PTP and PMP solution features an efficient GPS synchronized operational mode that permits highly scalable frequency reuse.

ePMP operates in the unlicensed 2.4 GHz, 2.5 GHz (Brazil only), 5 GHz and 6.4 GHz bands and supports a channel bandwidth of up to 40 MHz. It is available with an integrated antenna or in connectorized version for use with an external antenna.

The wireless link is primarily TDD based. System Release 1.2.3 added a Flexible Frame Ratio option which provides improved latency and throughput under unsynchronized operational mode.

From a network point-of-view, the ePMP wireless link is a transparent Layer 2 bridge. It offers limited switching capability in order to support a primary and a secondary (future release) Ethernet port on the Subscriber Module.

ePMP supports quality of service (QoS) classification capability and supports three traffic priorities. Management of the unit is conducted via the same interface as the bridged traffic (in-band Management).

System Release 1.3.4 adds support for RADIUS EAP-TTLS authentication and VSA support for MIR.

When deployed with a sector antenna, the ePMP 1000 GPS Sync Radio can be configured as a GPS synchronized Access Point serving ePMP Integrated Radios configured as Subscriber Modules. When deployed with a high gain point to point antenna, the ePMP GPS Sync Radio can be configured to be a GPS Synchronized Backhaul Master, forming a PTP link with another ePMP Radio module.

Powered by Hypure™ technology, ePMP 2000 features Smart Beamforming. This powerful addition to your network creates narrow, targeted beams to each subscriber, rather than relying on a traditional wide beam, blocking out multiple sources of interference to keep performance high.

ePMP 2000 also includes Intelligent Filtering, working automatically to clean up the signals received by the access point as well as keep its own transmissions clean. This helps not just that single access point reach optimum performance, but the whole tower too.

A summary of the main ePMP characteristics is listed under [Table 1](#).

**Table 1** Main characteristics of the ePMP Series

Characteristic	Value
Topology	PMP or PTP
Wireless link condition	LOS, near LOS

Scheduler	TDD (Fixed or Flexible Ratios), ePTP, Standard WiFi
Connectivity	Ethernet
Operating frequencies	ePMP 2000 Unlicensed bands, 5 GHz
	ePMP 1000 Unlicensed bands, 2.4 GHz, 2.5 GHz, 5 GHz, 6.4 GHz
Channel bandwidth	5 MHz, 10 MHz, 20 MHz or 40 MHz
Data rate	200+ Mbps

## TYPICAL INSTALLATION EQUIPMENT

The ePMP is a solution consisting of integrated or connectorized outdoor units, indoor power supply units/LAN injectors, cabling and surge suppression equipment.

The main hardware components of an ePMP installation are as follows:

- **ePMP 2000 Access Point with Intelligent Filtering and Sync or Connectorized Radio with GPS Sync (ePMP 1000):** A connectorized outdoor transceiver unit containing all the radio, networking, and surge suppression electronics.
- **ePMP 2000 Access Point with Intelligent Sync Power Supply or GPS Sync Connectorized Radio (ePMP 1000) Power Supply:** An indoor power supply module providing Power-over-Ethernet (PoE) supply and 1000/100/10 Base-TX to the Access Point.
- **ePMP 2000 Access Point with Intelligent Sync or GPS Sync Connectorized Radio (ePMP 1000) Radio Cabling and lightning protection:** Shielded Cat5e cables, grounding cables, and connectors.
- **Integrated Radio:** An integrated-antenna outdoor transceiver unit containing all the radio, networking, antenna, and surge suppression electronics.
- **Integrated or Un-sync Connectorized Radio:** A connectorized outdoor transceiver unit containing all the radio, networking and surge suppression electronics.
- **Integrated Radio Power Supply:** An indoor power supply module providing Power-over-Ethernet (PoE) supply and 100/10 Base-TX to the Subscriber Module.
- **Integrated Radio Cabling and lightning protection:** Shielded Cat5e cables and connectors

For more information about these components, including interfaces, specifications and Cambium part numbers, see [System hardware](#) on page 31.

### ePMP Elevate

ePMP Elevate is a software solution allowing fixed wireless broadband networks (2.4 and 5 GHz) to gain the powerful signature capabilities of Cambium Networks' ePMP platform, including frequency reuse enabled by GPS Synchronization and Smart Beamforming, even on non-Cambium 802.11n-based hardware.

Network migration is taken to the next level, solving a major pain-point for all wireless network operators. At a fraction of the cost and time of a total network replacement, an operator only needs to install an ePMP Access Point and to load their deployed subscriber modules with ePMP Elevate software. The hardware investment is protected, and the existing infrastructure is given a new lease of life to support revenue-generating applications for years to come.

ePMP Elevate networks can be managed by cnMaestro, the cloud-based or on-premise platform that provides end-to-end management, device onboarding, and maintenance support for wireless broadband networks from a single, easy-to-use interface.

Starting with Software Release 3.3, each ePMP AP is configured with one free ePMP Elevate license (to accept registration from one non-Cambium subscriber module).

For more information about ePMP Elevate, see the [ePMP Elevate website](#).

The screenshot shows the ePMP Elevate web interface. The top navigation bar includes the Cambium Networks logo, the device name 'NePMP\_7f8e8', and the role 'Subscriber Module'. The left sidebar contains navigation options: Home, Quick Start, Configuration, Monitor, Performance, System (selected), Wireless, Throughput Chart, Network, System Log, and Tools. The main content area is titled 'Monitor > System' and displays a table of system information.

Hardware Version	ePMP Elevate PBE-M5-400-XW
Serial number (MSN)	N/A
Firmware Version	U-Boot 1.1.4-s958 (Jun 10 2015 - 10:56:20)
Software Version	3.2-RC12
Device-Agent Version	2.60
Date and Time	01 Sep 2015, 00:01:35 GMT
System Uptime	1 minute, 38 seconds
Wireless MAC Address	44:D9:E7:7E:8F:E8
Ethernet MAC Address	44:D9:E7:7F:8F:E8
DFS Status	Channel Availability Check
Read-Only Users	0
Read-Write Users	1
SM Current GUI User Authentication	Device Local Only
Factory Reset Via Power Sequence	Enabled
cnMaestro Connection Status	Connecting in 1 minute
cnMaestro Account ID	--

Figure 1 ePMP Elevate subscriber example

## Wireless operation

This section describes how the ePMP wireless link is operated, including modulation modes, power control and security.

### TIME DIVISION DUPLEXING

#### *TDD cycle*

ePMP links operate using Time Division Duplexing (TDD). The links employ a TDD cycle in which the APs determines which SMs may transmit and when based on the configured downlink/uplink ratio (duty cycle). Three fixed Downlink/Uplink frame ratios are available – 75/25, 50/50 and 30/70. A flexible frame ratio is available as a fourth option where the AP dynamically determines the downlink and uplink ratio based on data demand in each direction.

### OFDM AND CHANNEL BANDWIDTH

The ePMP series transmits using Orthogonal Frequency Division Multiplexing (OFDM). This wideband signal consists of many equally spaced sub-carriers. Although each sub carrier is modulated at a low rate using conventional modulation schemes, the resultant data rate from all the sub-carriers is high.

The channel bandwidth of the OFDM signal is 5 MHz, 10 MHz, 20 MHz or 40 MHz, based on operator configuration.

Each channel is offset in center frequency from its neighboring channel by 5 MHz.

### ADAPTIVE MODULATION

The ePMP series can transport data over the wireless link using a number of different modulation modes ranging from 64-QAM to QPSK. For a given channel bandwidth and TDD frame structure, each modulation mode transports data at a fixed rate. Also, the receiver requires a given signal to noise ratio in order to successfully demodulate a given modulation mode. Although the more complex modulations such as 64QAM will transport data at a much higher rate than the less complex modulation modes, the receiver requires a much higher signal to noise ratio.

The ePMP series provides an adaptive modulation scheme where the receiver constantly monitors the quality of the received signal and notifies the far end of the link of the optimum modulation mode with which to transmit. In this way, optimum capacity is achieved at all times.

### MIMO

Multiple-Input Multiple-Output (MIMO) technique provides protection against fading and increases the probability of a received decoded signal to be usable.

The ePMP transmits two signals on the same radio frequency, one of which is 90 degrees offset from the other.

### RADAR AVOIDANCE

In regions where protection of radars is part of the local regulations, the ePMP must detect interference from radar-like systems and avoid co-channel operation with these systems.

To meet this requirement, the ePMP implements the following features:

- The equipment can only transmit on available channels, of which there are none at initial power up. The radar detection algorithm will always scan a usable channel for 60 seconds for radar interference before making the channel an available channel.
- This compulsory channel scan will mean that there is at least 60 seconds service outage every time radar is detected and that the installation time is extended by at least 60 seconds even if there is found to be no radar on the channel

There is a secondary requirement for bands requiring radar avoidance. Regulators have mandated that products provide a uniform loading of the spectrum across all devices. In general, this prevents operation with fixed frequency allocations.

However:



- ETSI regulations do allow frequency planning of networks (as that has the same effect of spreading the load across the spectrum).
- The FCC does allow channels to be avoided if there is actually interference on them.

**Note**

When operating in a region which requires DFS, ensure that the AP is configured with alternate frequencies and that the SM is configured to scan for these frequencies to avoid long outages.

## ENCRYPTION

The ePMP supports optional encryption for data transmitted over the wireless link. The encryption algorithm used is the Advanced Encryption Standard (AES) with 128-bit key size. AES is a symmetric encryption algorithm approved by U.S. Government organizations (and others) to protect sensitive information.

## COUNTRY CODES

Some aspects of wireless operation are controlled, enforced or restricted according to a country code. ePMP country codes represent individual countries (for example Denmark) or regulatory regions (for example FCC or ETSI).

Country codes affect the following aspects of wireless operation:

- Maximum transmit power
- Radar avoidance
- Frequency range

**Caution**

To avoid possible enforcement action by the country regulator, always operate links in accordance with local regulations

## SMART BEAMFORMING (EPMP 2000 SERIES)

- ePMP 2000 Smart Beamforming drastically reduces the effects of on-channel interference. The System learns the locations of each served Subscriber Module and forms a narrow beam towards the desired Subscriber Module while that radio is transmitting in the uplink. This reduces the gain on the uplink for on-channel interferers that are transmitting at an azimuth angle different than the Subscriber Module, delivering performance gains never before seen.



### Smart Antenna Key Advantages:

- **Eliminate Uplink Interference:** Smart Beamforming delivers dramatic performance improvements when dealing with strong co-channel uplink interference, maximizing network performance.
- **Consistent Performance in High Interference:** By mitigating significant sources of interference, packet loss and retransmissions are kept to a minimum, keeping your network applications working at their best.
- **Improvement in Uplink and Downlink Performance:** By eliminating packet loss and retransmissions resulting from co-channel uplink interference, TCP retransmissions are greatly reduced. Other applications also show significant performance benefits.
- **Intelligent Filtering (ePMP 2000 Series)**

- ePMP 2000 Intelligent Filtering improves both receive and transmit performance. It protects the network from off-channel interferers with a filter that dynamically moves around the channel. On the transmit side, it protects the RF environment by reducing off-channel transmission noise.

## PMP NETWORKS

### *Using frequency planning*

Frequency planning is the exercise of assigning operating channels to PMP units so as to minimize RF interference between links. Frequency planning must consider interference from any PMP unit to any other PMP unit in the network. Low levels of interference normally allow for stable operation and high link capacity.

The frequency planning task is made more straightforward by use of the following techniques:

- Using several different channels
- Separating units located on the same mast
- Configuring a 5 MHz guard band between adjacent sector operating band edges.

For help with planning networks, see [System planning](#) on page 98.

## FURTHER READING ON WIRELESS OPERATION

For information on planning wireless operation, see:

- The regulatory restrictions that affect radio spectrum usage, such as frequency range and radar avoidance is described under **Radio spectrum planning** on page **99**
- The factors to be taken into account when planning links such as range, path loss and data throughput are described under **Link planning** on page **103**.
- The safety specifications against which the ePMP has been tested are listed under **Compliance with safety standards** on page **426** . It also describes how to keep RF exposure within safe limits.
- How ePMP complies with the radio regulations that are enforced in various countries is explained in **Compliance with radio regulations** on page **444**.
- Compliance with the radio regulations that are enforced in various regions is explained in **Table 178** on page **447** through **Table 186** on page **465**.
- Tables and graphs to support calculation of the data rate capacity that can be provided by ePMP configurations are available at **Data throughput tables** on page **477** .

For more information on configuring and operating the wireless link, see:

- The configuration parameters of the ePMP devices described under **Configuration** on page **108**.
- Post-installation procedures and troubleshooting tips explained under **Operation and Troubleshooting** on page **294**.

## System management

This section introduces the ePMP management system, including the web interface, installation, alerts and upgrades, configuration and management software.

### MANAGEMENT AGENT

ePMP equipment is managed through an embedded management agent. Management workstations, network management systems or PCs can be connected to this agent using the module's Ethernet port or over the air (SM).

The management agent supports the following interfaces:

- Hypertext Transfer Protocol (HTTP)
- Hypertext Transfer Protocol secure (HTTPS)
- Simple Network Management Protocol (SNMP)
- Network Time Protocol (NTP)
- System logging (Syslog)
- Cambium Network Services Server (CNSS) software
- Dynamic Host Configuration Protocol (DHCP)

### WEB SERVER

The ePMP management agent contains a web server. The web server supports access via the HTTP and HTTPS interfaces.

Web-based management offers a convenient way to manage the ePMP equipment from a locally connected computer or from a network management workstation connected through a management network, without requiring any special management software. The web-based interfaces are the only interfaces supported for installation of ePMP, and for the majority of ePMP configuration management tasks.

**Figure 2** ePMP 1000 AP web-based management screenshot

The screenshot displays the web-based management interface for a Cambium Networks ePMP 1000 AP. The interface is divided into a navigation sidebar and a main content area. The sidebar includes links for Home, Quick Start, Configuration, Monitor, and Tools. The main content area shows the following system information:

Home	
Device Name:	ePMP1000_c0f8ed
SSID:	Cambium-AP
Operating Frequency:	5700 MHz
Operating Channel Bandwidth:	40 MHz
Transmitter Output Power:	7 dBm
Antenna Gain:	15 dBi
Country:	Other
Access Point Mode:	TD0
Downlink/Uplink Frame Ratio:	75/25
Wireless Security:	WPA2
cnMaestro Remote Management:	--
cnMaestro Connection Status:	Connected to cloud.cambiumnetworks.com
cnMaestro Account ID:	MARTIN_GRAY
Wireless MAC Address:	00:04:56:C6:F8:EE
Ethernet MAC Address:	00:04:56:C6:F8:ED
IP Address:	192.168.2.200
Date and Time:	01 Sep 2015, 00:01:18 GMT
System Uptime:	1 minute, 22 seconds
System Description:	--
Sync Source Status:	GPS Sync Up
Device Coordinates:	--
Ethernet Status:	1000 Mbps / Full
Wireless Status:	Up
Registered Subscriber Modules:	1

© 2016 Cambium Networks. All Rights Reserved | Version 3.1 | Support | Community Forum

Figure 3 ePMP 2000 AP web-based management screenshot

Home		Home	
Device Name	ePMP2000_018485	Wireless MAC Address	020456D18485
Vendor	Cambium-AP	Ethernet MAC Address	889456D18485
Operating Frequency	5800 MHz	IP Address	10.130.210.134
Operating Channel Bandwidth	20 MHz	Date and Time	14 Nov 2016, 18:06:29 GMT
Transmitter Output Power	13 dBm	System Uptime	14 minutes, 44 seconds
Antenna Gain	17 dBi	System Description	Medium
Country	United States	Sync Source Status	GPS Sync Up
Access Point Mode	TDD	Device Coordinates	52.89, 17.88
Downlink/Uplink Frame Ratio	50/50	GPS Status	Not Available
Wireless Security	Open	Ethernet Status	100 Mbps / Full
cnMaestro Remote Management	--	Wireless Status	Up
cnMaestro Connection Status	Connected to qa.cloud.cambiumnetworks.com	Registered Subscriber Modules	3
cnMaestro Account ID	88820UM_C7M9GQA	Uplink Antenna	Smart Antenna
		Smart Antenna	Smart Antenna is Disconnected, Power On
		Power Supply	Generic Power Supply

© 2016 Cambium Networks. All Rights Reserved | Version 3.1 | Support | Community Forum

## Web pages

The web-based management interfaces provide comprehensive web-based fault, configuration, performance and security management functions organized into the following web-pages and groups:

Access Point and Subscriber Module web-pages:

- **Dashboard:** The Dashboard web-page reports the general device status, session status, remote subscriber status, event log information, and network interface status.
- **Configure:** The Configuration web-page may be utilized for configuring general device parameters, as well as IP, radio, SNMP, Quality of Service (QoS), security, time, VLAN, protocol filtering, and unit settings.
- **Monitor:** The Monitor web-page reports detailed operating statistics for the radio link and network, and reports system log information.
- **Tools:** The tools web-page offers useful tools for device installation, configuration, and operation including software upgrade, backup/restore, spectrum analyzer, throughput test, ping test, and traceroute.
- **Quick Start:** The Quick Start web-page provides quick access to requisite parameters for radio link establishment and network access.

## Identity-based user accounts

When identity-based user accounts are configured, a security officer can define from one to four user accounts, each of which may have one of the four possible roles:

- **ADMINISTRATOR** (default username/password “admin”), who has full read and write permission.
- **INSTALLER** (default username/password “installer”), who has permission to read and write parameters applicable to unit installation and monitoring.
- **HOME** (default username/password “home”), who has permission only to access pertinent information for support purposes

- READONLY (default username/password “readonly”), who has permission to only view the Monitor page.

## SNMP

The management agent supports fault and performance management by means of an SNMP interface. The management agent is compatible with SNMP v2c using one Management Information Base (MIB) file which is available for download from the Cambium Networks Support website (<https://support.cambiumnetworks.com/files/epmp>).

## NETWORK TIME PROTOCOL (NTP)

The clock supplies accurate date and time information to the system. It can be set to run with or without a connection to a network time server (NTP). It can be configured to display local time by setting the time zone and daylight saving in the Time web page.

If an NTP server connection is available, the clock can be set to synchronize with the server time at regular intervals.

ePMP devices may receive NTP data from a CMM3 or CMM4 module or an NTP server configured in the system’s management network.

The Time Zone option is configurable on the AP’s **Configure => System** page and may be used to offset the received NTP time to match the operator’s local time zone.

## CNMAESTRO™

cnMaestro is a cloud-based or on-site platform designed to monitor, configure, operate, upgrade, manage and monitor ePMP systems. For more information, see the [cnMaestro website](#).

## SOFTWARE UPGRADE

Software upgrades may be issued via the radio web interface (**Tools => Software Upgrade**) or via CNSS (Cambium Networks Services Server). For Software upgrades, see

<https://support.cambiumnetworks.com/files/epmp>.

## FURTHER READING ON SYSTEM MANAGEMENT

For more information on system management, see:

- **AP System page** on page **147**
- **SM System page** on page **211**
- **Operation and Troubleshooting** on page 294

## System hardware

This chapter describes the site planning and hardware components of an ePMP link.

The following topics are described in this chapter:

- Factors to be considered when planning the proposed network is described under **Installation and Safety** on page **32**.
- The ePMP 2000 Access Point with Intelligent Filtering and Sync module hardware, part numbers, mounting equipment, and specifications are described under **ePMP 2000 Access Point with Intelligent Filtering and Sync** on page **35**.
- The ePMP 1000 Connectorized with Sync module hardware, part numbers, mounting equipment, and specifications are described under **ePMP 1000 Connectorized Radio with Sync** on page **44**.
- The ePMP 1000 Integrated hardware, part numbers, mounting equipment and specifications are described under **ePMP 1000 Integrated Radio** on page **52** (ePMP 1000).
- The ePMP 1000 Connectorized hardware, part numbers, mounting equipment and specifications are described under **ePMP 1000 Connectorized Radio** on page **57** (ePMP 1000).
- The Force 130 hardware, part numbers, mounting equipment and specifications are described under **Force 130** on page **65**.
- The Force 180 hardware, part numbers, mounting equipment and specifications are described under **Force 180** on page **65**.
- The Force 190 hardware, part numbers, mounting equipment and specifications are described under **Force 190** on page **75**.
- The Force 200 hardware, part numbers, mounting equipment and specifications are described under **Force 200** on page **82**.
- The power supply hardware, part numbers and specifications are described under **ePMP 1000 Series Power Supply** on page **92**.
- The AP sector antenna (including optional Smart Antenna) part numbers are described under **ePMP 2000 Access Point with Intelligent Filtering and Sync, antennas and antenna cabling** on page **42** (ePMP 2000) **ePMP 1000 Connectorized Radio with Sync, antennas and antenna cabling** on page **50** (ePMP 1000).
- Cable standards and lengths are described under **Ethernet cabling** on page **95**.
- Surge suppression requirements and recommendations are described under **Surge suppression unit** on page **97**.

## Installation and Safety

Conduct a site survey to ensure that the proposed AP and SM sites meet the requirements defined in this section.

### SITE INSTALLATION

An ePMP site typically consists of a high supporting structure such as a mast, tower or building for the AP or SM.

There is only one Ethernet interface, a copper Cat5e connection from the AP or SM to the AP/SM power supply and network terminating equipment. If a 1000 Base-TX (Gigabit) Ethernet connection is required at the AP, ensure that power supply N000900L001B (ePMP 1000) or N000000L034A (ePMP 2000) is utilized.

### GROUNDING AND LIGHTNING PROTECTION

Structures, equipment and people must be protected against power surges (typically caused by lightning) by conducting the surge current to ground via a separate preferential solid path. The actual degree of protection required depends on local conditions and applicable local regulations. To adequately protect an ePMP installation, both ground bonding and transient voltage surge suppression are required.



#### Warning

Electro-magnetic discharge (lightning) damage is not covered under warranty. The recommendations in this guide, when followed correctly, give the user the best protection from the harmful effects of EMD. However 100% protection is neither implied nor possible.

Details of lightning protection methods and requirements can be found in the international standards IEC 61024-1 and IEC 61312-1, the U.S. National Electric Code ANSI/NFPA No. 70-1984 or section 54 of the Canadian Electric Code.





Note

International and national standards take precedence over the requirements in this guide.

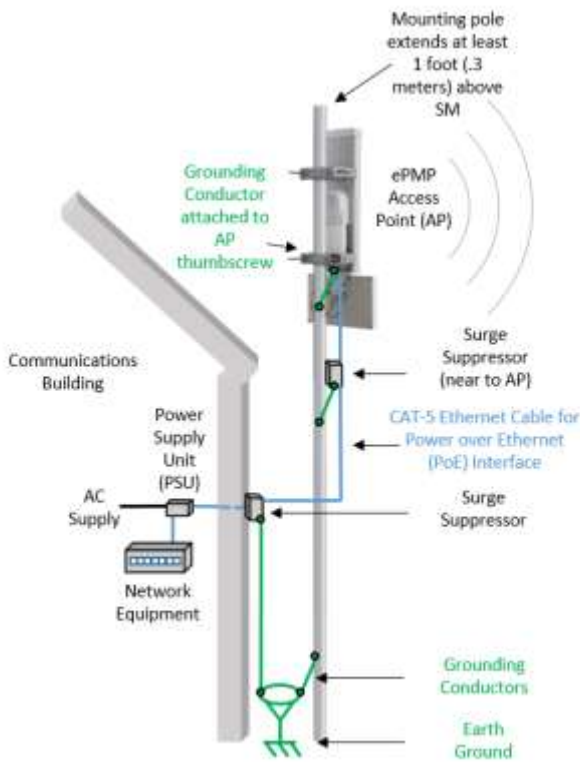

Figure 4 AP Cabling Diagram

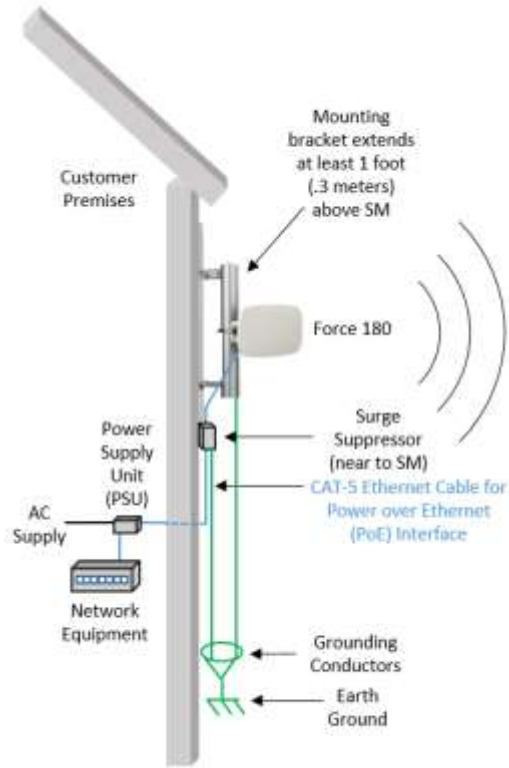

Figure 5 SM Cabling Diagram

### LIGHTNING PROTECTION ZONES

Use the rolling sphere method (Figure 6) to determine where it is safe to mount equipment. An imaginary sphere, typically 50 meters in radius, is rolled over the structure. Where the sphere rests against the ground and a strike termination device (such as a finial or ground bar), all the space under the sphere is considered to be in the zone of protection (Zone B). Similarly, where the sphere rests on two finials, the space under the sphere is considered to be in the zone of protection.

**Figure 6** Rolling sphere method to determine the lightning protection zones

Assess locations on masts, towers and buildings to determine if the location is in Zone A or Zone B:

- **Zone A:** In this zone a direct lightning strike is possible. Do not mount equipment in this zone.
- **Zone B:** In this zone, direct EMD (lightning) effects are still possible, but mounting in this zone significantly reduces the possibility of a direct strike. Mount equipment in this zone.

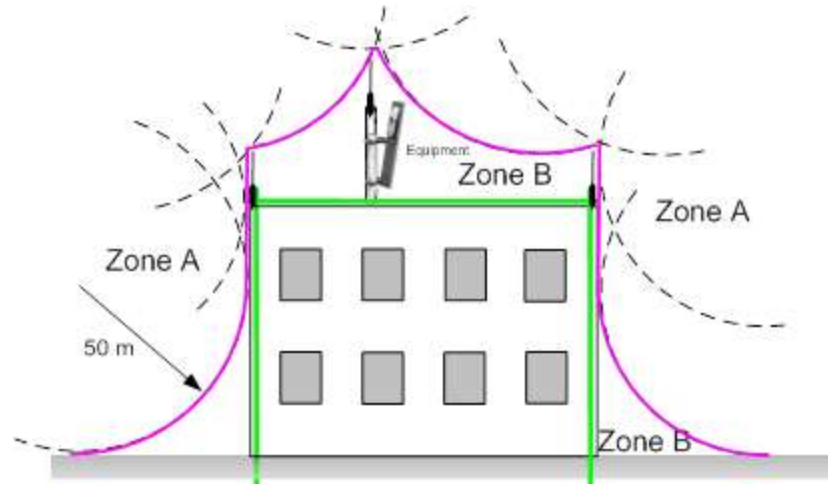
**Warning**

Do not mount equipment in Zone A which can put the equipment, structures and life at risk.

## ePMP 2000

### ePMP 2000 Access Point with Intelligent Filtering and Sync

For details of the ePMP 2000 Access Point with Intelligent Filtering and Sync connectorized hardware, see:

- ePMP 2000 Access Point with Intelligent Filtering and Sync description on page 35
- ePMP 2000 Access Point with Intelligent Filtering and Sync part numbers on page 36
- ePMP 2000 Access Point with Intelligent Filtering and Sync mounting bracket on page 37
- ePMP 2000 Access Point with Intelligent Filtering and Sync interfaces on page 38
- ePMP 2000 Access Point with Intelligent Filtering and Sync LEDs on page 38
- ePMP 2000 Access Point with Intelligent Filtering and Sync specifications on page 39
- ePMP 2000 Access Point with Intelligent Filtering and Sync heater on page [41](#)
- ePMP 2000 Access Point with Intelligent Filtering and Sync - external antenna location on page 41
- ePMP 2000 Access Point with Intelligent Filtering and Sync wind loading on page 41
- ePMP 2000 Access Point with Intelligent Filtering and Sync software packages on page 42
- ePMP 2000 Access Point with Intelligent Filtering and Sync, antennas and antenna cabling on page 42
- 

### ePMP 2000 ACCESS POINT WITH INTELLIGENT FILTERING AND SYNC DESCRIPTION

The ePMP 2000 Access Point with Intelligent Filtering and Sync device is a self-contained transceiver unit that houses both radio and networking electronics. The connectorized unit is designed to work with externally mounted antennas that have high gains to cope with difficult radio conditions. The unit is designed with female RP-SMA 50Ω antenna connections located at the top of the unit and female RP-SMA 50Ω DC-coupled for connection to the optional Smart Antenna (detected upon connection/power on).



#### Note

To select antennas, RF cables and connectors for connectorized units, see ePMP 2000 Access Point with Intelligent Filtering and Sync, antennas and antenna cabling on page 42.

**Figure 7** ePMP 2000 Series Access Point with Intelligent Filtering and Sync



## ePMP 2000 ACCESS POINT WITH INTELLIGENT FILTERING AND SYNC PART NUMBERS

Choose the correct regional variant: one is for use in regions where FCC or IC licensing restrictions apply (FCC/IC), one is for use in ETSI countries (EU), and one is for non-FCC/IC/ETSI-restricted regions (RoW).

Each of the parts listed in **Table 2** includes the following items:

- One connectorized unit
- One power supply 1000/100/10 Base-TX LAN injector

The GPS-capable parts listed in **Table 2** also ship with a GPS antenna.

**Table 2** ePMP 2000 Access Point with Intelligent Filtering and Sync part numbers

Cambium description	Cambium part number
ePMP 2000: 5 GHz AP with Intelligent Filtering and Sync (EU)	C050900A033A
ePMP 2000: 5 GHz AP with Intelligent Filtering and Sync (FCC)	C058900A132A
ePMP 2000: 5 GHz AP with Intelligent Filtering and Sync (ROW) (no cord)	C050900A031A
ePMP 2000: 5 GHz AP with Intelligent Filtering and Sync (ROW) (EU cord)	C050900A231A
ePMP 2000: 5 GHz AP with Intelligent Filtering and Sync (ROW) (US cord)	C050900A131A
ePMP 2000: 5 GHz AP with Intelligent Filtering and Sync (EU) (UK cord)	C050900A333A
ePMP 2000: 5 GHz AP with Intelligent Filtering and Sync (ROW) (UK cord)	C050900A331A
ePMP 2000: 5 GHz AP with Intelligent Filtering and Sync (ROW) (India cord)	C050900A431A
ePMP 2000: 5 GHz AP with Intelligent Filtering and Sync (ROW) (China cord)	C050900A531A
ePMP 2000: 5 GHz AP with Intelligent Filtering and Sync (ROW) (Brazil cord)	C050900A631A
ePMP 2000: 5 GHz AP with Intelligent Filtering and Sync (ROW)(Argentina cord)	C050900A731A
ePMP 2000: 5 GHz AP with Intelligent Filtering and Sync (ROW)(ANZ cord)	C050900A831A
ePMP 2000: 5 GHz AP Lite with Intelligent Filtering and Sync (EU)	C050900L033A
ePMP 2000: 5 GHz AP Lite with Intelligent Filtering and Sync (FCC)	C058900L132A
ePMP 2000: 5 GHz AP Lite with Intelligent Filtering and Sync (ROW) (no cord)	C050900L031A
ePMP 2000: 5 GHz AP Lite with Intelligent Filtering and Sync (ROW) (EU cord)	C050900L231A
ePMP 2000: 5 GHz AP Lite with Intelligent Filtering and Sync (ROW) (US cord)	C050900L131A
ePMP 2000: 5 GHz AP Lite with Intelligent Filtering and Sync (EU) (UK cord)	C050900L333A
ePMP 2000: 5 GHz AP Lite with Intelligent Filtering and Sync (ROW) (UK cord)	C050900L331A
ePMP 2000: 5 GHz AP Lite with Intelligent Filtering and Sync (ROW) (India cord)	C050900L431A
ePMP 2000: 5 GHz AP Lite with Intelligent Filtering and Sync (ROW) (China cord)	C050900L531A
ePMP 2000: 5 GHz AP Lite with Intelligent Filtering and Sync (ROW) (Brazil cord)	C050900L631A

ePMP 2000: 5 GHz AP Lite with Intelligent Filtering and Sync (ROW)(Argentina cord)	C050900L731A
ePMP2000 AP Lite License Key – Upgrade Lite (10 SM) to Full (120 SM)	C050900S2KLA

**Table 3** Access Point with Intelligent Filtering and Sync accessory part numbers

Cambium description	Cambium part number
POWER SUPPLY, 30W, 56V – Gbps support	N000000L034

## ePMP 2000 ACCESS POINT WITH INTELLIGENT FILTERING AND SYNC MOUNTING BRACKET

The ePMP 2000 Access Point with Intelligent Filtering and Sync is designed to be attached to the new Cambium ePMP sector antenna (see [Table 10](#)). The new Cambium ePMP sector antenna contains all of the mounting brackets, antenna cabling, and GPS antenna mounting for device installation.

**Figure 8** ePMP 2000 Access Point with Intelligent Filtering and Sync mounted to ePMP sector antenna



## ePMP 2000 ACCESS POINT WITH INTELLIGENT FILTERING AND SYNC INTERFACES

The ePMP 2000 Access Point with Intelligent Filtering and Sync interfaces are illustrated in **Figure 9** and described in **Table 4**.

**Figure 9** Connectorized Radio with Sync interfaces

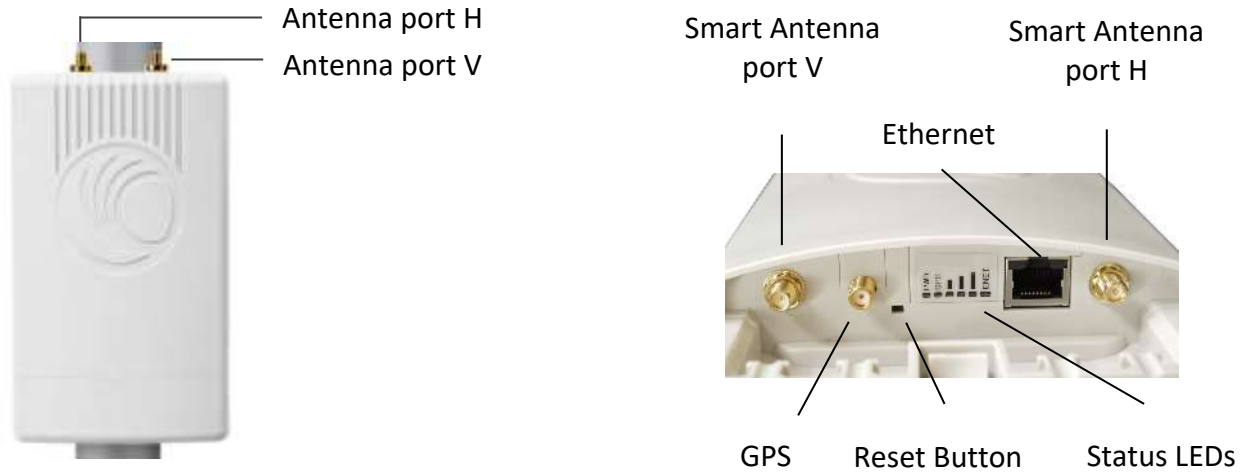

**Table 4** ePMP 2000 Access Point with Intelligent Filtering and Sync interfaces

Name	Connector	Interface	Description
Antenna port H	RP-SMA, female	Antenna, H polarization	To/from H polarized antenna port
Antenna port V	RP-SMA, female	Antenna, V polarization	To/from V polarized antenna port
Smart Antenna port H	RP-SMA, female	Smart Antenna, H polarization	To/from H polarized Smart Antenna port
Smart Antenna port V	RP-SMA, female	Smart Antenna, V polarization	To/from V polarized Smart Antenna port
Ethernet	RJ45	PoE input	802.3at-compliant Please note: A non-802.3at-compliant power supply may also be used to power the device. The power supply must supply at least 20 Watts.
		10/100/1000 Base-TX Ethernet	Management and data
GPS	SMA, female	Antenna, GPS	To/from GPS antenna
Reset Button	Physical button	N/A	For resetting the radio and for setting the radio back to its factory default configuration. See <b>Using the device external reset button</b> on page 304.

## ePMP 2000 ACCESS POINT WITH INTELLIGENT FILTERING AND SYNC LEDS

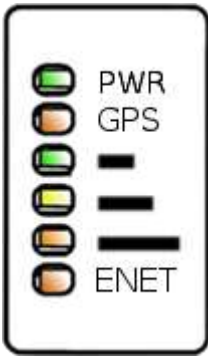

LED	Function
POWER	Green: Power is applied to the device Unlit: No power is applied to the device or improper power source
GPS SYNC	Orange: AP has acquired a 1PPS GPS synchronization pulse either from the internal GPS module and antenna or from a connected CMM Unlit: 1PPS GPS not acquired, or <b>Synchronization Source</b> set to <b>Internal</b> (AP operates without sync)
	No LEDs lit: Three or less satellites tracked One LED lit: Four or five satellites tracked Two LEDs lit: Six or seven satellites tracked All LEDs lit: Eight or more satellites are tracked
ETH	Once lit, blinking indicates Ethernet activity Red: 10BaseTX link Green: 100BaseTX link Orange: 1000BaseTX link Unlit: No Ethernet link established

## ePMP 2000 ACCESS POINT WITH INTELLIGENT FILTERING AND SYNC SPECIFICATIONS

The ePMP 2000 Access Point with Intelligent Filtering and Sync connectorized module conforms to the specifications listed in [Table 5](#) and [Table 6](#).

The connectorized module meets the low level static discharge specifications identified in [Electromagnetic compatibility \(EMC\) compliance](#) on page [428](#) and provides internal surge suppression but does not provide lightning suppression.

For a full listing of Access Point with Intelligent Filtering and Sync specifications, see the [ePMP 2000 website](#).

**Table 5** ePMP 2000 Access Point with Intelligent Filtering and Sync physical specifications

Category	Specification
Dimensions (H x W x D)	Radio: 22.2 x 12.4 x 4.5 cm (8.75 x 4.9 x 1.75 in) without brackets
Weight	.7 kg (1.5 lbs) without brackets

**Table 6** ePMP 2000 Access Point with Intelligent Filtering and Sync environmental specifications

Category	Specification
Temperature	-30°C (-22°F) to +55°C (131°F)
Wind loading	118 mph (190 kph) maximum. See <a href="#">ePMP 2000 Access Point with Intelligent Filtering and Sync wind loading</a> on page <a href="#">41</a> for a full description.

---

Humidity	95% condensing
Environmental	IP55

---



## ePMP 2000 ACCESS POINT WITH INTELLIGENT FILTERING AND SYNC HEATER

At startup, if the ePMP 2000 Access Point with Intelligent Filtering and Sync module temperature is at or below 32° F (0° C), an internal heater is activated to ensure that the device is able to successfully begin operation. The unit’s heater is only activated when the unit is powered on and will not apply heat to the device once startup is complete. When the unit temperature is greater than 32° F (0° C), the heater is deactivated and the unit continues its startup sequence.

The effect on device startup time at various temperatures is defined in [Table 7](#).

**Table 7** ePMP 2000 Access Point with Intelligent Filtering and Sync startup times based on ambient temperature

Initial Temperature	Startup time (from power on to operational)
-22° F (-30° C)	20 minutes
-4° F (-20° C)	6 minutes
14° F (-10° C)	2 minutes, 30 seconds

## ePMP 2000 ACCESS POINT WITH INTELLIGENT FILTERING AND SYNC - EXTERNAL ANTENNA LOCATION

Find a location for the device and external antenna that meets the following requirements:

- The equipment is high enough to achieve the best radio path.
- People can be kept a safe distance away from the equipment when it is radiating. The safe separation distances are defined in [Calculated distances and power compliance margins](#) on page 430.
- The equipment is lower than the top of the supporting structure (tower, mast or building) or its lightning air terminal.
- The location is not subject to excessive wind loading. For more information, see [ePMP 2000 Access Point with Intelligent Filtering and Sync wind loading](#) on page 41.

## ePMP 2000 ACCESS POINT WITH INTELLIGENT FILTERING AND SYNC WIND LOADING

Ensure that the device and the structure on which it is mounted are capable of withstanding the prevalent wind speeds at a proposed ePMP site. Wind speed statistics are available from national meteorological offices.

The device and its mounting bracket are capable of withstanding wind speeds of up to 190 kph (118 mph).

Wind blowing on the device will subject the mounting structure to significant lateral force. The magnitude of the force depends on both wind strength and surface area of the device. Wind loading is estimated using the following formulae:

$$\text{Force (in kilograms)} = 0.1045aV^2$$

Where:	Is:
a	surface area in square meters
V	wind speed in meters per second

$$\text{Force (in pounds)} = 0.0042Av^2$$

Where:	Is:
A	surface area in square feet
v	wind speed in miles per hour

Applying these formulae to the ePMP device at different wind speeds, the resulting wind loadings are shown in **Table 17** and **Table 18**.

**Table 8** ePMP 2000 Access Point with Intelligent Filtering and Sync wind loading (Kg)

Type of ePMP device	Largest surface area (square meters)	Wind speed (meters per second)				
		30	40	50	60	70
Connectorized with Sector Antenna	0.09	8.5 Kg	15 Kg	23.5 Kg	33.9 Kg	46.1 Kg

**Table 9** ePMP 2000 Access Point with Intelligent Filtering and Sync wind loading (lb)

Type of ePMP device	Largest surface area (square feet)	Wind speed (miles per hour)				
		80	100	120	140	150
Connectorized with Sector Antenna	1	26.9 lb	42 lb	60.1 lb	82.32 lb	107.5 lb

## ePMP 2000 ACCESS POINT WITH INTELLIGENT FILTERING AND SYNC SOFTWARE PACKAGES

ePMP 2000 Access Point with Intelligent Filtering and Sync devices may be upgraded by downloading new software packages from the Cambium Networks website or by using the Cambium Network Services Server. The software packages applicable to ePMP connectorized radios are named:

- ePMP-GPS\_Synced-[Version].tar.gz

## ePMP 2000 ACCESS POINT WITH INTELLIGENT FILTERING AND SYNC, ANTENNAS AND ANTENNA CABLING

ePMP 2000 Access Point with Intelligent Filtering and Sync devices require external antennas connected using RF cables (included with Cambium ePMP sector antennas). For details of the antennas and accessories required for a connectorized ePMP installation, see:

- **Antenna requirements** on **page 43**
- **FCC and IC approved antennas** on **page 43**

## ANTENNA REQUIREMENTS

For ePMP 2000 Access Point with Intelligent Filtering and Sync units operating in the USA or Canada 5 GHz bands, choose external antennas from those listed in **FCC and IC approved antennas** on **page 43**. For installations in other countries, the listed antennas are advisory, not mandatory.

## FCC AND IC APPROVED ANTENNAS

For ePMP 2000 Access Point with Intelligent Filtering and Sync units operating in the USA or Canada, choose external antennas from **Table 10**. These are approved by the FCC for use with the product and are constrained by the following limits:

- 5 GHz – 18 dBi gain



### Caution

Using other than approved antennas may cause measurements higher than reported for certification.

This radio transmitter (IC certification number 109W-0005) has been approved by Industry Canada to operate with the antenna types listed below with the maximum permissible gain and required antenna impedance for each antenna type indicated. Antenna types not included in this list, having a gain greater than the maximum gain indicated for that type, are strictly prohibited for use with this device.

Le présent émetteur radio (Numéro de certification IC 109W-0005) a été approuvé par Industrie Canada pour fonctionner avec les types d'antenne énumérés ci-dessous et ayant un gain admissible maximal et l'impédance requise pour chaque type d'antenne. Les types d'antenne non inclus dans cette liste, ou dont le gain est supérieur au gain maximal indiqué, sont strictement interdits pour l'exploitation de l'émetteur.

**Table 10** ePMP 2000 Allowed antennas for installation in USA/Canada

Cambium part number	Antenna Type	Gain (dBi)
<b>C050900D021A</b>	<b>5 GHz Sector Antenna – 90/120 degree</b>	<b>18</b>
<b>C050900D020A</b>	<b>Smart Antenna (complimentary to Sector Antenna, does not replace Sector Antenna)</b>	<b>-</b>

## ePMP 1000

### ePMP 1000 Connectorized Radio with Sync

For details of the ePMP connectorized hardware, see:

- [ePMP 1000 Connectorized Radio with Sync description](#) on page 44
- [ePMP 1000 Connectorized Radio with Sync part numbers](#) on page 44
- [ePMP 1000 Connectorized Radio with Sync interfaces](#) on page 46
- [ePMP 1000 Connectorized Radio with Sync specifications](#) on page 47
- [ePMP 1000 Connectorized Radio with Sync and external antenna location](#) on page 49
- [ePMP 1000 Connectorized Radio with Sync wind loading](#) on page 49
- [ePMP 1000 Connectorized Radio with Sync software packages](#) on page 50
- [ePMP 1000 Connectorized Radio with Sync, antennas and antenna cabling](#) on page 50

### ePMP 1000 CONNECTORIZED RADIO WITH SYNC DESCRIPTION

The connectorized ePMP device is a self-contained transceiver unit that houses both radio and networking electronics. The connectorized unit is designed to work with externally mounted antennas that have high gains. Connectorized units can cope with more difficult radio conditions. The unit is designed with female RP-SMA 50Ω antenna connections located at the top of the unit. An ePMP connectorized unit may function as an Access Point (AP) or a Subscriber Module (SM) in a Point-To-Multipoint (PMP) or in a Point-To-Point (PTP) network topology.



#### Note

To select antennas, RF cables and connectors for connectorized units, see ePMP 1000 Connectorized Radio with Sync, antennas and antenna cabling on page 50.

**Figure 10** ePMP 1000 Series Connectorized Radio with Sync



### ePMP 1000 CONNECTORIZED RADIO WITH SYNC PART NUMBERS

Choose the correct regional variant: one is for use in regions where FCC or IC licensing restrictions apply (FCC/IC), one is for use in ETSI countries (EU), and one is for non-FCC/IC/ETSI-restricted regions (RoW).

Each of the parts listed in [Table 11](#) includes the following items:

- One connectorized unit
- One power supply 1000/100/10 Base-TX LAN injector

The GPS-capable parts listed in [Table 11](#) also ship with a GPS antenna.

**Table 11** ePMP 1000 Connectorized Radio with Sync part numbers

Cambium description	Cambium part number
ePMP GPS, Conn - 2.4 GHz - US power cord	C024900A011A
ePMP GPS, Conn - 2.5 GHz – no power cord – Brazil only	C025900A611A
ePMP GPS, Conn - 5 GHz - no power cord – ROW version	C050900A011A
ePMP GPS, Conn - 5 GHz – no power cord – EU version	C050900A013A
ePMP GPS, Conn - 5 GHz - US power cord – FCC version	C058900A112A
ePMP GPS, Conn – 6.4 GHz – no power cord – ROW version	C060900A211A
GPS Sync AP License Key – ePMP 1000 GPS Sync AP License Key - Upgrade Lite (10 SM) to Full (120 SM)	C050900S200A

**Table 12** ePMP 1000 Connectorized Radio with Sync accessory part numbers

Cambium description	Cambium part number
ePMP Power Supply for GPS Radio - no cord (spare)	N000900L001B
ePMP Power Supply for non-GPS Radio - no cord (spare)	N000900L002A

## ePMP 1000 CONNECTORIZED RADIO WITH SYNC MOUNTING BRACKET

The connectorized unit is designed to be attached to a Cambium ePMP sector antenna (see [Table 19](#)). The Cambium ePMP sector antenna contains all of the mounting brackets, antenna cabling, and GPS antenna mounting for device installation.

**Figure 11** ePMP 1000 Connectorized Radio with Sync sector antenna



### ePMP 1000 CONNECTORIZED RADIO WITH SYNC INTERFACES

The connectorized radio with sync interfaces are illustrated in **Figure 12** and described in **Table 13**.

**Figure 12** ePMP 1000 Connectorized Radio with Sync interfaces

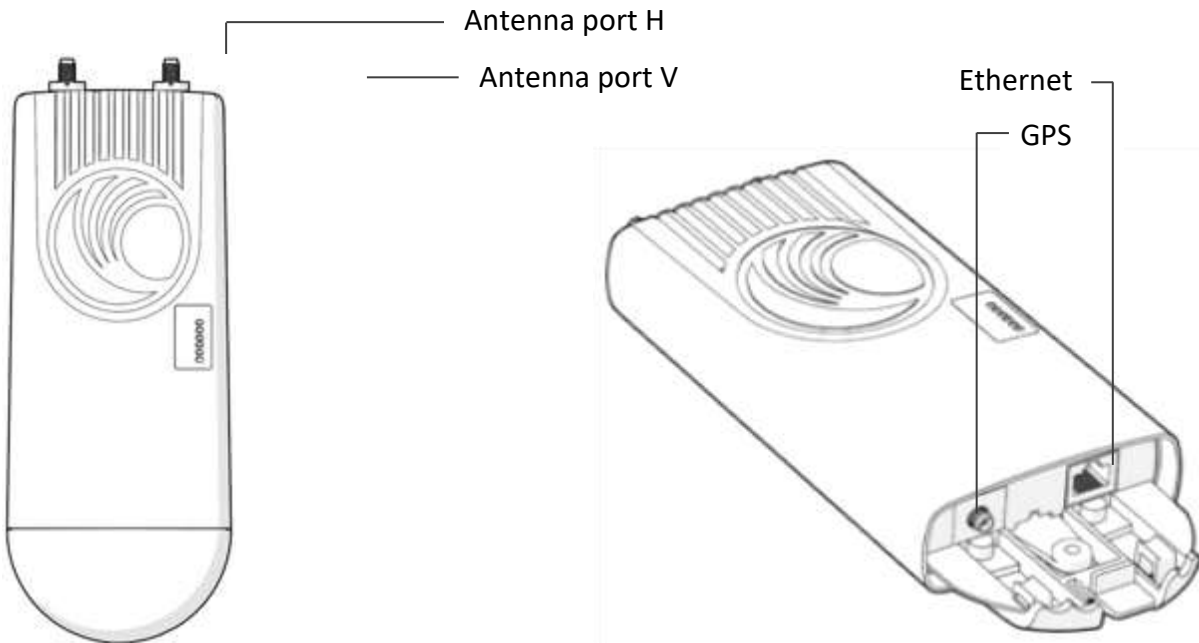

**Table 13** ePMP 1000 Connectorized Radio with Sync interfaces

Name	Connector	Interface	Description
Antenna port H	RP-SMA, female	Antenna, H polarization	To/from H polarized antenna port
Antenna port V	RP-SMA, female	Antenna, V polarization	To/from V polarized antenna port
Ethernet	RJ45	PoE input	802.3af PoE Standard, as well as Proprietary power over Ethernet (PoE) twisted pair (for powering via CMM3/CMM4)
		10/100/1000 Base-TX Ethernet	Management and data
GPS	SMA, female	Antenna, GPS	To/from GPS antenna
Reset Button	Physical button	N/A	For resetting the radio and for setting the radio back to its factory default configuration. See <a href="#">Using the device external reset button</a> on page 304.

### ePMP 1000 CONNECTORIZED RADIO WITH SYNC LEDS

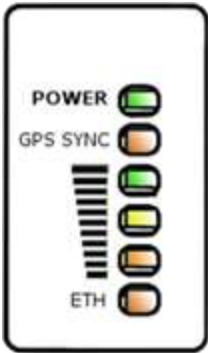

LED	Function
POWER	Green: Power is applied to the device Unlit: No power is applied to the device or improper power source
GPS SYNC	Orange: AP has acquired a 1PPS GPS synchronization pulse either from the internal GPS module and antenna or from a connected CMM Unlit: 1PPS GPS not acquired, or <b>Synchronization Source</b> set to <b>Internal</b> (AP operates without sync)
	No LEDs lit: Three or less satellites tracked One LED lit (bottom): Four or five satellites tracked Two LEDs lit (bottom two): Six or seven satellites tracked All LEDs lit: Eight or more satellites are tracked
ETH	Once lit, blinking indicates Ethernet activity Red: 10BaseTX link Green: 100BaseTX link Orange: 1000BaseTX link Unlit: No Ethernet link established

### ePMP 1000 CONNECTORIZED RADIO WITH SYNC SPECIFICATIONS

The ePMP connectorized module conforms to the specifications listed in [Table 14](#) and [Table 15](#).

The connectorized module meets the low level static discharge specifications identified in [Electromagnetic compatibility \(EMC\) compliance](#) on page 428 and provides internal surge suppression but does not provide lightning suppression.

For a full listing of connectorized radio with sync specifications, see the [ePMP 1000 website](#).

**Table 14** ePMP 1000 Connectorized Radio with Sync physical specifications

Category	Specification
Dimensions (H x W x D)	Radio: 227 x 88 x 33 mm (8.9" x 3.5" x 1.3") Antenna: 529 x 124 x 53 mm (20.8" x 4.9" x 2.1")
Weight	.521 kg (1.15 lbs) without antenna 4.5 kg (10 lbs) with antenna

**Table 15** ePMP 1000 Connectorized Radio with Sync environmental specifications

Category	Specification
Temperature	-30°C (-22°F) to +55°C (131°F)
Wind loading	118 mph (190 kph) maximum. See <a href="#">ePMP 1000 Connectorized Radio with Sync wind loading on page 49</a> for a full description.
Humidity	95% condensing
Environmental	IP55



## ePMP 1000 CONNECTORIZED RADIO WITH SYNC HEATER

At startup, if the ePMP connectorized module temperature is at or below 32° F (0° C), an internal heater is activated to ensure that the device is able to successfully begin operation. The unit’s heater is only activated when the unit is powered on and will not apply heat to the device once startup is complete. When the unit temperature is greater than 32° F (0° C), the heater is deactivated and the unit continues its startup sequence.

The effect on device startup time at various temperatures is defined in [Table 16](#).

**Table 16** ePMP 1000 Connectorized Radio with Sync startup times based on ambient temperature

Initial Temperature	Startup time (from power on to operational)
-22° F (-30° C)	20 minutes
-4° F (-20° C)	6 minutes
14° F (-10° C)	2 minutes, 30 seconds

## ePMP 1000 CONNECTORIZED RADIO WITH SYNC AND EXTERNAL ANTENNA LOCATION

Find a location for the device and external antenna that meets the following requirements:

- The equipment is high enough to achieve the best radio path.
- People can be kept a safe distance away from the equipment when it is radiating. The safe separation distances are defined in [Calculated distances and power compliance margins](#) on page 430.
- The equipment is lower than the top of the supporting structure (tower, mast or building) or its lightning air terminal.
- The location is not subject to excessive wind loading. For more information, see [ePMP 1000 Connectorized Radio with Sync wind loading](#) on page 49.

## ePMP 1000 CONNECTORIZED RADIO WITH SYNC WIND LOADING

Ensure that the device and the structure on which it is mounted are capable of withstanding the prevalent wind speeds at a proposed ePMP site. Wind speed statistics is available from national meteorological offices.

The device and its mounting bracket are capable of withstanding wind speeds of up to 190 Kph (118 mph).

Wind blowing on the device will subject the mounting structure to significant lateral force. The magnitude of the force depends on both wind strength and surface area of the device. Wind loading is estimated using the following formulae:

Force (in kilograms) = 0.1045aV<sup>2</sup>

Where:

a

surface area in square meters

V

wind speed in meters per second

Force (in pounds) = 0.0042Av<sup>2</sup>

Where:

A

surface area in square feet

v

wind speed in miles per hour

Applying these formulae to the ePMP device at different wind speeds, the resulting wind loadings are shown in **Table 17** and **Table 18**.

**Table 17** ePMP 1000 Connectorized Radio with Sync wind loading (Kg)

Type of ePMP device	Largest surface area (square meters)	Wind speed (meters per second)				
		30	40	50	60	70
Connectorized	0.13	12.2 Kg	21.7 Kg	34 Kg	49 Kg	66.6 Kg

**Table 18** ePMP 1000 Connectorized Radio with Sync wind loading (lb)

Type of ePMP device	Largest surface area (square feet)	Wind speed (miles per hour)				
		80	100	120	140	150
Connectorized	1.39	37.4 lb	58.4 lb	84.1 lb	114.4 lb	131.4 lb

## ePMP 1000 CONNECTORIZED RADIO WITH SYNC SOFTWARE PACKAGES

Connectorized radios may be upgraded by downloading new software packages from the Cambium Networks website or by using the Cambium Network Services Server. The software packages applicable to ePMP connectorized radios are named:

- ePMP-GPS\_Synced-[Version].tar.gz

## ePMP 1000 CONNECTORIZED RADIO WITH SYNC, ANTENNAS AND ANTENNA CABLING

Connectorized modules require external antennas connected using RF cable (included with Cambium ePMP sector antennas).

For details of the antennas and accessories required for a connectorized ePMP installation, see:

- ePMP 1000 Antenna** requirements on page 51
- ePMP 1000 FCC and IC approved antennas** on page 51

## ePMP 1000 ANTENNA REQUIREMENTS

For connectorized units operating in the USA or Canada 2.4 GHz, 5.2 GHz, 5.4 GHz or 5.8 GHz bands, choose external antennas from those listed in **ePMP 1000 FCC and IC approved antennas** on page 51. For installations in other countries, the listed antennas are advisory, not mandatory.

## ePMP 1000 FCC AND IC APPROVED ANTENNAS

For connectorized units operating in the USA or Canada, choose external antennas from **Table 19**. These are approved by the FCC for use with the product and are constrained by the following limits:

- 5 GHz – 15 dBi gain
- 2.4 GHz - 15 dBi gain



### Caution

Using other than approved antennas may cause measurements higher than reported for certification.

This radio transmitter (IC certification number 109W-0005) has been approved by Industry Canada to operate with the antenna types listed below with the maximum permissible gain and required antenna impedance for each antenna type indicated. Antenna types not included in this list, having a gain greater than the maximum gain indicated for that type, are strictly prohibited for use with this device.

Le présent émetteur radio (Numéro de certification IC 109W-0005) a été approuvé par Industrie Canada pour fonctionner avec les types d'antenne énumérés ci-dessous et ayant un gain admissible maximal et l'impédance requise pour chaque type d'antenne. Les types d'antenne non inclus dans cette liste, ou dont le gain est supérieur au gain maximal indiqué, sont strictement interdits pour l'exploitation de l'émetteur.

**Table 19** ePMP 1000 Allowed antennas for installation in USA/Canada

Cambium part number	Antenna Type	Gain (dBi)
<b>C050900D021A</b>	<b>5 GHz Sector Antenna – 90/120 degree</b>	<b>18</b>
<b>C050900D003A</b>	<b>5 GHz Sector Antenna – 90 degree</b>	<b>15</b>
<b>C050900D002A</b>	<b>5 GHz Sector Antenna – 120 degree</b>	<b>15</b>
<b>C024900D004A</b>	<b>2.4 GHz Sector Antenna - 90 /120 degree</b>	<b>15</b>

## ePMP 1000 Integrated Radio

For details of the ePMP 1000 integrated hardware, see:

- [ePMP 1000 Integrated Radio description](#) on page 52
- [ePMP 1000 Integrated Radio part numbers](#) on page 52
- [ePMP 1000 Integrated Radio mounting bracket](#) on page 53
- [ePMP 1000 Integrated Radio interfaces](#) on page 53
- [ePMP 1000 Integrated Radio specifications](#) on page 54
- [ePMP 1000 Integrated Radio heater](#) on page 55
- [ePMP 1000 Integrated Radio wind loading](#) on page 55
- [ePMP 1000 Integrated Radio software packages](#) on page 56.
- 

## ePMP 1000 INTEGRATED RADIO DESCRIPTION

**Figure 13** ePMP 1000 Series Integrated Radio

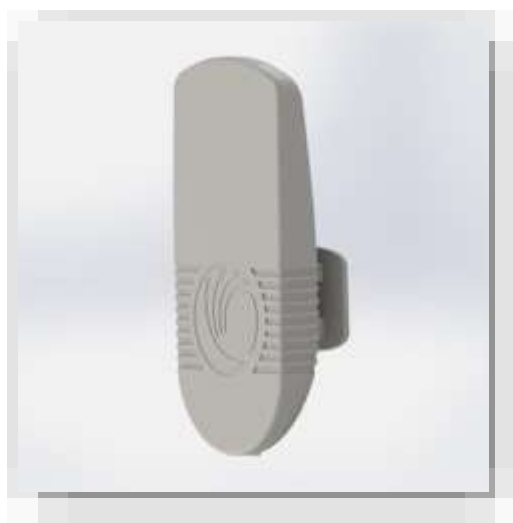

The integrated ePMP 1000 module is a self-contained transceiver unit that houses both radio and networking electronics. An ePMP 1000 integrated unit may function as an Access Point (AP) or a Subscriber Module (SM) in a Point-To-Multipoint (PMP) or in a Point-To-Point (PTP) network topology.

## ePMP 1000 INTEGRATED RADIO PART NUMBERS

Choose the correct regional variant: one is for use in regions where FCC or IC licensing restrictions apply (FCC/IC), one is for use in ETSI countries (EU), and one is for non-FCC/IC/ETSI-restricted regions (RoW).

Each of the parts listed in [Table 20](#) includes the following items:

- One integrated module (with mounting bracket)
- One metal mounting strap
- Power supply

**Table 20** ePMP 1000 Integrated Radio part numbers

Cambium description	Cambium part number
ePMP Integrated – 5 GHz – no power cord – ROW version	C050900C031A
ePMP Integrated – 5 GHz – EU power cord – EU version	C050900P033A
ePMP Integrated – 5 GHz – US power cord – FCC version	C058900C132A
ePMP Integrated - 2.4 GHz - US power cord	C024900C031A

**Table 21** ePMP 1000 Integrated Radio accessory part numbers

Cambium description	Cambium part number
ePMP Power Supply for non-GPS Radio - no cord (spare)	N000900L002A

### ePMP 1000 INTEGRATED RADIO MOUNTING BRACKET

The ePMP 1000 integrated module is designed to be pole-mounted using the mounting strap and bracket provided in the box with the radio.

**Figure 14** Integrated module mounting bracket

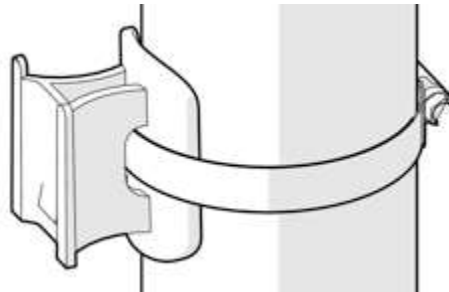

### ePMP 1000 INTEGRATED RADIO INTERFACES

The integrated module interfaces are illustrated in **Figure 15** and described in **Table 22**.

**Figure 15** ePMP 1000 Integrated Radio interfaces

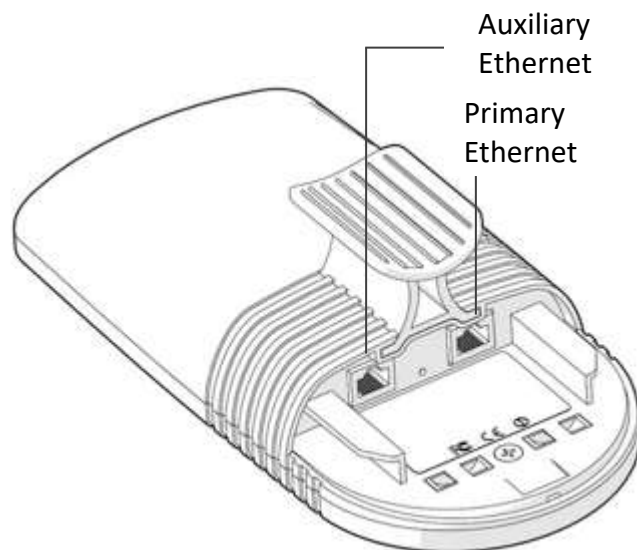
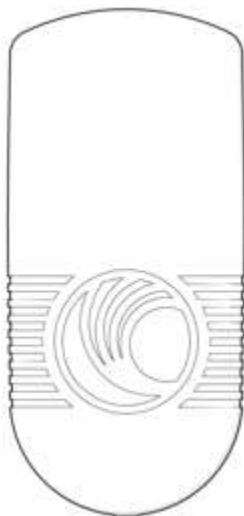

**Table 22** ePMP 1000 Integrated Radio interfaces

Port name	Connector	Interface	Description
Primary Ethernet	RJ45	PoE input	Proprietary power over Ethernet (PoE) twisted pair (for powering via CMM3/CMM4)
		10/100 Base-TX Ethernet	Management and data
Auxiliary Ethernet (future release)	RJ45	Cambium proprietary PoE output, data bridging	<b>Proprietary 30V PoE</b> output for auxiliary devices (not 802.3af standard PoE)

### ePMP 1000 INTEGRATED RADIO LEDS

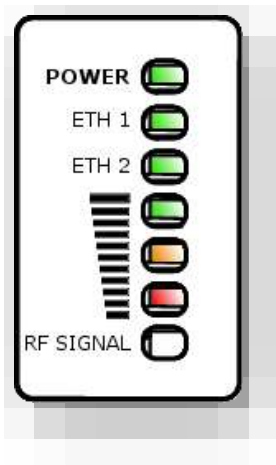

LED	Function
POWER	Green: Power is applied to the device
	Unlit: No power is applied to the device or improper power source
ETH 1	Main/Primary Ethernet port indicator
	Once lit, blinking indicates Ethernet activity Green: 10/100BaseTX link
ETH 2	Auxiliary/Secondary Ethernet port indicator
	Once lit, blinking indicates Ethernet activity Green: 10/100BaseTX link



RF SIGNAL

Radio scanning: LEDs light in an ascending sequence to indicate that the radio is scanning

Radio registered: LEDs light to indicate the RSSI level at the device.



### ePMP 1000 INTEGRATED RADIO SPECIFICATIONS

The ePMP integrated module conforms to the specifications listed in [Table 23](#) and [Table 24](#).

The integrated device meets the low level static discharge specifications identified in [Electromagnetic compatibility \(EMC\) compliance](#) on page [428](#) and provides internal surge suppression but does not provide lightning suppression.

For a full listing of integrated radio specifications, see [ePMP 1000 website](#).

**Table 23** ePMP 1000 Integrated Radio physical specifications

Category	Specification
Dimensions (H x W x D)	Radio: 29.1 x 14.5 x 8.3 cm (11.4 x 5.7 x 3.3 in)
Weight	0.49 kg (1.1 lbs)

**Table 24** ePMP 1000 Integrated Radio environmental specifications

Category	Specification
Temperature	-30°C (-22°F) to +60°C (131°F)
Wind loading	90 mph (145 kph) maximum. See <a href="#">ePMP 1000 Integrated Radio wind loading</a> on page 55 for a full description.
Humidity	95% condensing
Environmental	IP55

## ePMP 1000 INTEGRATED RADIO HEATER

Upon power on, if the ePMP integrated module device temperature is at or below 32° F (0° C), an internal heater is activated to ensure that the device is able to successfully begin operation. The unit's heater is only activated when the unit is powered on and will not apply heat to the device once startup is complete. When the unit temperature is greater than 32° F (0° C), the heater is deactivated and the integrated module continues its startup sequence.

The effect on integrated module startup time at various temperatures is defined in [Table 25](#).

**Table 25** ePMP 1000 Integrated module startup times based on ambient temperature

Initial Temperature	Startup time (from power on to operational)
-22° F (-30° C)	4 minutes
-4° F (-20° C)	2 minutes
14° F (-10° C)	1 minutes, 30 seconds

## ePMP 1000 INTEGRATED RADIO WIND LOADING

Ensure that the integrated module and the structure on which it is mounted are capable of withstanding the prevalent wind speeds at a proposed ePMP site. Wind speed statistics must be available from national meteorological offices.

The integrated module and its mounting bracket are capable of withstanding wind speeds of up to 145 Kph (90 mph).

Wind blowing on the integrated module will subject the mounting structure to significant lateral force. The magnitude of the force depends on both wind strength and surface area of the integrated module. Wind loading is estimated using the following formulae:

$$\text{Force (in kilograms)} = 0.1045aV^2$$

Where:

Is:

a surface area in square meters  
 V wind speed in meters per second

$$\text{Force (in pounds)} = 0.0042Av^2$$

Where: A surface area in square feet  
 v wind speed in miles per hour

Applying these formulae to the ePMP integrated module at different wind speeds, the resulting wind loadings are shown in **Table 26** and **Table 27**.

**Table 26** ePMP 1000 Integrated Radio wind loading (Kg)

Type of ePMP module	Largest surface area (square meters)	Wind speed (meters per second)				
		30	40	50	60	70
Integrated	0.042	4 Kg	7 Kg	11 Kg	15.8 Kg	21.6 Kg

**Table 27** ePMP 1000 Integrated Radio wind loading (lb)

Type of ePMP module	Largest surface area (square feet)	Wind speed (miles per hour)				
		80	100	120	140	150
Integrated	0.45	12.1 lb	18.9 lb	27.2 lb	37 lb	42.5 lb

## ePMP 1000 INTEGRATED RADIO SOFTWARE PACKAGES

Integrated radios may be upgraded by downloading new software packages from the Cambium Networks website or by using the Cambium Network Services Server. The software packages applicable to ePMP integrated radios are named:

- ePMP-NonGPS\_Synced-[Version].tar.gz



## ePMP 1000 Connectorized Radio

For details of the ePMP 1000 connectorized hardware, see:

- ePMP 1000 Connectorized Radio description on page 57
- ePMP 1000 Connectorized Radio part numbers on page 57
- ePMP 1000 Connectorized Radio Interfaces on page 59
- ePMP 1000 Connectorized Radio specifications on page 60
- ePMP 1000 Connectorized Radio and external antenna location on page 62
- ePMP 1000 Connectorized Radio wind loading on page 62
- Connectorized Radio software packages on page 63
- ePMP 1000 Connectorized Radio antennas and antenna cabling on page 63
- 

### ePMP 1000 CONNECTORIZED RADIO DESCRIPTION

Figure 16 ePMP 1000 Series Connectorized Radio

The connectorized ePMP 1000 device is a self-contained transceiver unit that houses both radio and networking electronics. The connectorized unit is designed to work with externally mounted antennas that have high gains. Connectorized units can cope with more difficult radio conditions. The unit is designed with female RP-SMA 50Ω antenna connections located at the top of the unit. An ePMP 1000 connectorized unit may function as an Access Point (AP) or a Subscriber Module (SM) in a Point-To-Multipoint (PMP) or in a Point-To-Point (PTP) network topology.



#### Note

To select antennas, RF cables and connectors for connectorized units, [see ePMP 1000 Connectorized Radio antennas and antenna cabling](#) on page 63.

### ePMP 1000 CONNECTORIZED RADIO PART NUMBERS

Choose the correct regional variant: one is for use in regions where FCC or IC licensing restrictions apply (FCC/IC), one is for use in ETSI countries (EU), and one is for non-FCC/IC/ETSI-restricted regions (RoW).

Each of the parts listed in **Table 28** includes the following items:

- One connectorized unit
- One power supply 100/10 Base-TX LAN injector

**Table 28** ePMP 1000 Connectorized Radio part numbers

Cambium description	Cambium part number
ePMP Conn – 2.4 GHz – US power cord	C024900A021A
ePMP Conn – 2.5 GHz – no power cord – Brazil only	C025900A611A
ePMP Conn – 5 GHz – no power cord – ROW version	C050900A021A
ePMP Conn – 5 GHz – EU power cord – EU version	C050900A023A
ePMP Conn – 5 GHz – US power cord – FCC version	C058900A122A
ePMP Conn – 6.4 GHz – no power cord – ROW version	C060900A221A

**Table 29** ePMP 1000 Connectorized Radio accessory part numbers

Cambium description	Cambium part number
ePMP Power Supply for non-GPS Radio - no cord (spare)	N000900L002A

## ePMP 1000 CONNECTORIZED RADIO MOUNTING BRACKET

The ePMP 1000 Connectorized unit is designed to be attached to a Cambium ePMP sector antenna or with a non-Cambium antenna.

**Figure 17** Connectorized radio sector antenna



## ePMP 1000 CONNECTORIZED RADIO INTERFACES

The connectorized radio with interfaces are illustrated in **Figure 18** and described in **Table 30**.

**Figure 18** Connectorized radio interfaces

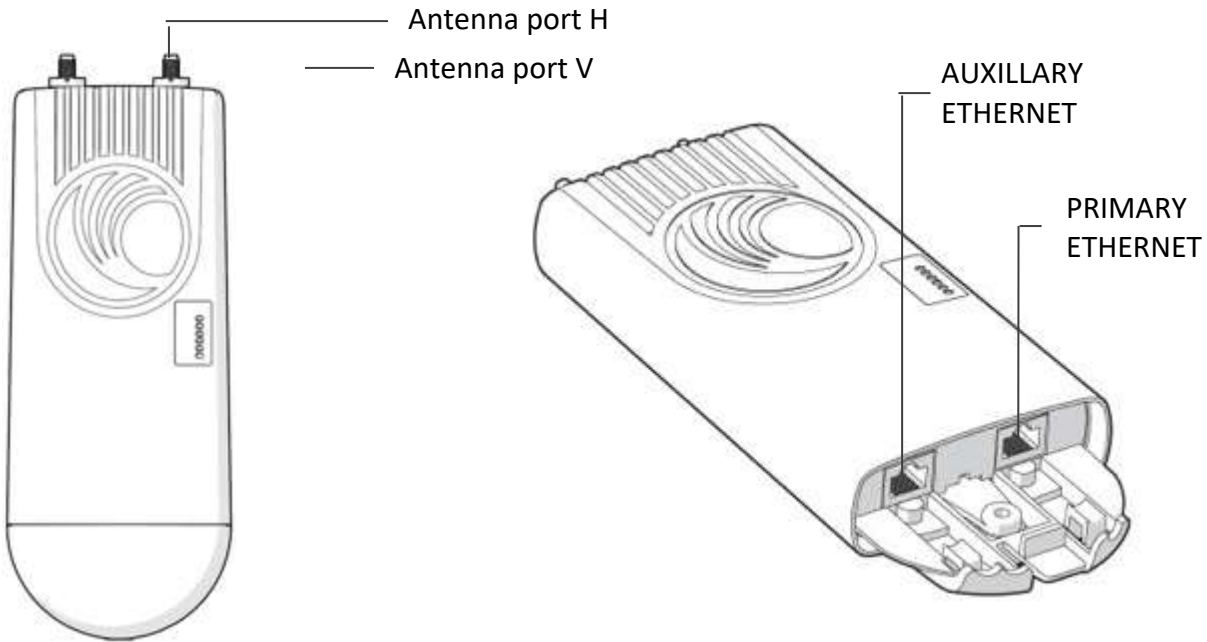

**Table 30** ePMP 1000 Connectorized radio interfaces

Name	Connector	Interface	Description
Antenna port H	RP-SMA, female	Antenna, H polarization	To/from H polarized antenna port
Antenna port V	RP-SMA, female	Antenna, V polarization	To/from V polarized antenna port
Primary Ethernet	RJ45	PoE input	Proprietary power over Ethernet (PoE) twisted pair (for powering via CMM3/CMM4)
		10/100 Base-TX Ethernet	Management and data
Auxiliary Ethernet (future release)	RJ45	Cambium propriety PoE output, data bridging	<b>Propriety 30V PoE</b> output for auxiliary devices (not 802.3af standard PoE)
Reset Button	Physical button	N/A	For resetting the radio and for resetting the radio back to its factory default configuration, see Using the device external reset button on page 304.

## ePMP 1000 CONNECTORIZED RADIO LEDS

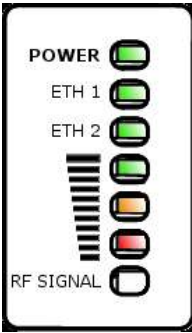

LED	Function
POWER	Green: Power is applied to the device Unlit: No power is applied to the device or improper power source
ETH 1	Main/Primary Ethernet port indicator Once lit, blinking indicates Ethernet activity Green: 10/100BaseTX link
ETH 2	Auxiliary/Secondary Ethernet port indicator Once lit, blinking indicates Ethernet activity Green: 10/100BaseTX link Radio scanning: LEDs light in an ascending sequence to indicate that the radio is scanning Radio registered: LEDs light to indicate the RSSI level at the device.
	Reserved for future release



### ePMP 1000 CONNECTORIZED RADIO SPECIFICATIONS

The ePMP connectorized radio conforms to the specifications listed in [Table 31](#) and [Table 32](#).

The connectorized module meets the low level static discharge specifications identified in [Electromagnetic compatibility \(EMC\) compliance](#) on page [428](#) and provides internal surge suppression but does not provide lightning suppression.

For a full listing of connectorized radio specifications, see [ePMP 1000 website](#).

**Table 31** ePMP 1000 Connectorized radio physical specifications

Category	Specification
Dimensions (H x W x D)	Radio: 227 x 88 x 33 mm (8.9" x 3.5" x 1.3") Antenna: 529 x 124 x 53 mm (20.8" x 4.9" x 2.1")
Weight	.521 kg (1.15 lbs) without antenna 4.5 kg (10 lbs) with antenna

**Table 32** ePMP 1000 Connectorized radio environmental specifications

Category	Specification
Temperature	-30°C (-22°F) to +55°C (131°F)
Wind loading	118 mph (190 kph) maximum. See <a href="#">ePMP 1000 Connectorized Radio wind loading</a> on page 62 for a full description.
Humidity	95% condensing
Environmental	IP55

## ePMP 1000 CONNECTORIZED RADIO HEATER

On startup, if the ePMP 1000 Connectorized radio temperature is at or below 32° F (0° C), an internal heater is activated to ensure that the device is able to successfully begin operation. The unit’s heater is only activated when the unit is powered on and will not transfer heat to the device until the startup completes. When the unit temperature is greater than 32° F (0° C), the heater is deactivated and the unit continues its startup sequence.

The effect on device startup time at various temperatures is defined in [Table 33](#).

**Table 33** ePMP 1000 Connectorized radio startup times based on ambient temperature

Initial Temperature	Startup time (from power on to operational)
-22° F (-30° C)	20 minutes
-4° F (-20° C)	6 minutes
14° F (-10° C)	2 minutes, 30 seconds

## ePMP 1000 CONNECTORIZED RADIO AND EXTERNAL ANTENNA LOCATION

Find a location for the device and external antenna that meets the following requirements:

- The equipment is high enough to achieve the best radio path.
- People are a safe distance away from the equipment when it is radiating. The safe separation distances are defined in [Calculated distances and power compliance margins](#) on page 430.
- The equipment is lower than the top of the supporting structure (tower, mast or building) or its lightning air terminal.
- The location is not subjected to excessive wind loading. For more information, see [ePMP 1000 Connectorized Radio wind loading](#) on page 62.

## ePMP 1000 CONNECTORIZED RADIO WIND LOADING

Ensure that the device and the structure on which it is mounted are capable of withstanding the prevalent wind speeds at a proposed ePMP site. Wind speed statistics must be available from national meteorological offices.

The device and its mounting bracket are capable of withstanding wind speeds of up to 190 kph (118 mph).

Wind speeds on the device subjects the mounting structure to significant lateral force. The magnitude of the force depends on both the wind strength and surface area of the device. Wind loading is estimated using the following formulae:

$$\text{Force (in kilograms)} = 0.1045aV^2$$

Where:

a

V

Is:

surface area in square meters

wind speed in meters per second

$$\text{Force (in pounds)} = 0.0042Av^2$$

Where:

A

v

Is:

surface area in square feet

wind speed in miles per hour

Applying these formulae to the ePMP device at different wind speeds, the resulting wind loadings are shown in [Table 34](#) and [Table 35](#).

**Table 34** ePMP 1000 Connectorized radio wind loading (Kg)

Type of ePMP device	Largest surface area (square meters)	Wind speed (meters per second)				
		30	40	50	60	70
Connectorized	0.13	12.2 Kg	21.7 Kg	34 Kg	49 Kg	66.6 Kg

**Table 35** ePMP 1000 Connectorized radio wind loading (lb)

Type of ePMP device	Largest surface area (square feet)	Wind speed (miles per hour)				
		80	100	120	140	150
Connectorized	1.39	37.4 lb	58.4 lb	84.1 lb	114.4 lb	131.4 lb

## CONNECTORIZED RADIO SOFTWARE PACKAGES

Connectorized radio may be upgraded by downloading new software packages from the Cambium Networks website or by using the Cambium Network Services Server. The software packages applicable to ePMP 1000 Un-synced connectorized radio are named:

- ePMP-NonGPS\_Synced-[Version].tar.gz

## ePMP 1000 CONNECTORIZED RADIO ANTENNAS AND ANTENNA CABLING

Connectorized radio requires external antennas connected using RF cable (included with Cambium ePMP sector antennas). For details of the antennas and accessories required for a connectorized ePMP installation, see:

- [ePMP 1000 Antenna](#) requirements on page [51](#)
- [ePMP 1000 FCC and IC approved antennas](#) on page [51](#)

## ePMP 1000 ANTENNA REQUIREMENTS

For connectorized units operating in the USA or Canada 2.4 GHz, 5.4 GHz or 5.8 GHz bands, choose external antennas from those listed in **ePMP 1000 FCC and IC approved antennas** on page 51. For installations in other countries, the listed antennas are advisory, not mandatory.

## ePMP 1000 FCC AND IC APPROVED ANTENNAS

For connectorized units operating in the USA or Canada, choose external antennas from **Table 36**. These are approved by the FCC for use with the product and are constrained by the following limits:

- 5 GHz – 15 dBi gain
- 2.4 GHz - 15 dBi gain
- 



Caution

Using other than approved antennas may cause measurements higher than reported for certification.

This radio transmitter (IC certification number 109W-0005) has been approved by Industry Canada to operate with the antenna types listed below with the maximum permissible gain and required antenna impedance for each antenna type indicated.

Antenna types not included in this list, having a gain greater than the maximum gain indicated for that type, are strictly prohibited for use with this device.

- Le présent émetteur radio (Numéro de certification IC 109W-0005) a été approuvé par Industrie Canada pour fonctionner avec les types d'antenne énumérés ci-dessous et ayant un gain admissible maximal et l'impédance requise pour chaque type d'antenne. Les types d'antenne non inclus dans cette liste, ou dont le gain est supérieur au gain maximal indiqué, sont strictement interdits pour l'exploitation de l'émetteur.

**Table 36** ePMP 1000 allowed antennas for installation in USA/Canada – 5 GHz

Cambium part number	Antenna Type	Gain (dBi)
<b>C050900D003A</b>	<b>5 GHz Sector Antenna – 90 degree</b>	<b>15</b>
<b>C050900D002A</b>	<b>5 GHz Sector Antenna – 120 degree</b>	<b>15</b>
<b>C024900D004A</b>	<b>2.4 GHz Sector Antenna - 90 /120 degree</b>	<b>15</b>



## Force 130

For details of the ePMP Force 130 hardware, see:

- [Force 130 description](#) on page 65
- [Force 130 part numbers](#) on page 65
- [Force 130 mounting](#) on page 66
- [Force 130 interfaces](#) on page 67
- [Force 130 LEDs](#) on page 68
- [Force 130 specifications](#) on page 68
- [Force 130 software packages](#) on page 69

## FORCE 130 DESCRIPTION

The Force 130 integrated module available in both 5 GHz and 2.4 GHz is a self-contained transceiver unit that houses both radio and networking electronics. An ePMP Force 130 unit may function as an Access Point (AP) or a Subscriber Module (SM) in a Point-To-Multipoint (PMP) or in a Point-To-Point (PTP) network topology. It is typically deployed as an SM in a PMP system.

**Figure 19** ePMP Series Force 130



## FORCE 130 PART NUMBERS

Choose the correct regional variant, one is for use in ETSI countries (EU), and one is for non-FCC/IC/ETSI-restricted regions (RoW).

Each of the parts listed in [Table 37](#) includes the following items:

- One Force 130 module (with mounting bracket)
- Two plastic mounting strap
- Power supply

**Table 3** Force 130 part numbers

Cambium description	Cambium part number
ePMP 2.4 GHz Force 130 SM (ROW) (no cord)	C024900C603A
ePMP 2.4 GHz Force 130 SM (ROW) (US cord)	C024900C604A
ePMP 2.4 GHz Force 130 SM (ROW) (EU cord)	C024900C605A
ePMP 2.4 GHz Force 130 SM (ROW) (UK cord)	C024900C606A
ePMP 2.4 GHz Force 130 SM (ROW) (India cord)	C024900C607A
ePMP 2.4 GHz Force 130 SM (ROW) (China cord)	C024900C609A
ePMP 2.4 GHz Force 130 SM (ROW) (Brazil cord)	C024900C610A
ePMP 2.4 GHz Force 130 SM (ROW) (Argentina cord)	C024900C611A
ePMP 2.4 GHz Force 130 SM (ROW) (ANZ cord)	C024900C612A
ePMP 2.4 GHz Force 130 SM (ROW) (South Africa cord)	C024900C613A
ePMP 2.4 GHz Force 130 SM (ROW) (No PSU)	C024900C614A
ePMP 5 GHz Force 130 SM (ROW) (ANZ cord)	C050900C513A
ePMP 5 GHz Force 130 SM (EU) (EU cord)	C050900C502A
ePMP 5 GHz Force 130 SM (EU) (UK cord)	C050900C503A
ePMP 5 GHz Force 130 SM (ROW) (no cord)	C050900C504A
ePMP 5 GHz Force 130 SM (ROW) (US cord)	C050900C505A
ePMP 5 GHz Force 130 SM (ROW) (EU cord)	C050900C506A
ePMP 5 GHz Force 130 SM (ROW) (UK cord)	C050900C507A
ePMP 5 GHz Force 130 SM (ROW) (India cord)	C050900C508A
ePMP 5 GHz Force 130 SM (India) (India cord)	C050900C509A
ePMP 5 GHz Force 130 SM (ROW) (China cord)	C050900C510A
ePMP 5 GHz Force 130 SM (ROW) (Brazil cord)	C050900C511A
ePMP 5 GHz Force 130 SM (ROW) (Argentina cord)	C050900C512A
ePMP 5 GHz Force 130 SM (ROW) (ANZ cord)	C050900C513A
ePMP 5 GHz Force 130 SM (ROW) (South Africa cord)	C050900C514A
ePMP 5 GHz Force 130 SM (ROW) (No PSU)	C050900C515A

## FORCE 130 MOUNTING

Figure 20 Force 130 module mounting

The Force 130 module is designed to be pole-mounted using the mounting straps provided in the box with the radio.

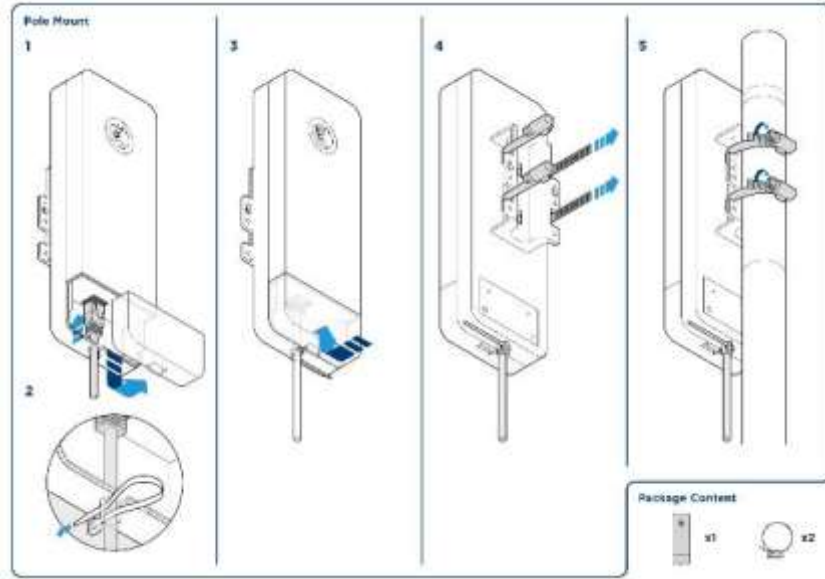

### FORCE 130 INTERFACES

The Force 130 module interfaces are illustrated in Figure 21 and described in Table 38.

Figure 21 Force 130 interfaces

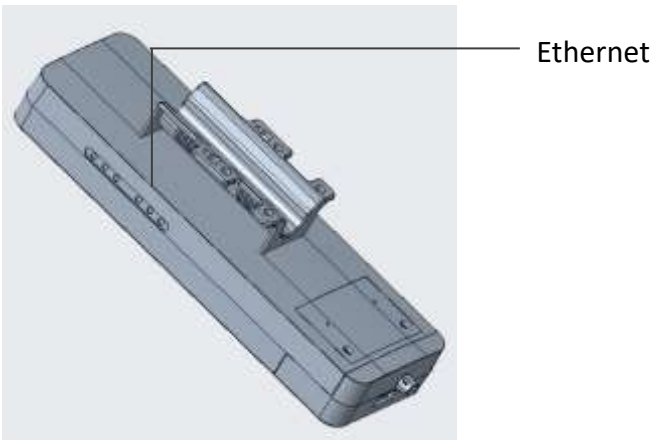
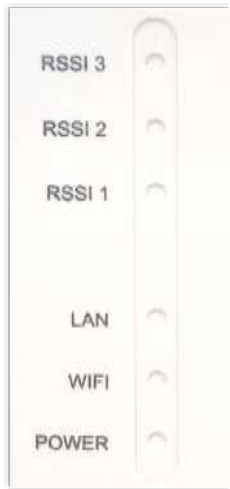



Table 37 Force 130 interfaces

Port name	Connector	Interface	Description
Ethernet	RJ45	24V PoE input	10/100 BaseT
		100 Base-TX Ethernet	Management and data
Reset Button	Physical button	N/A	For resetting the radio and for setting the radio back to its factory default configuration. See <a href="#">Using the device external reset button</a> on page 304.

## FORCE 130 LEDS



LED	Function
POWER	Green: Power is applied to the device Unlit: No power is applied to the device or improper power source
WiFi	XXX
LAN	XXX

 RF SIGNAL

Radio scanning: LEDs light in an ascending sequence to indicate that the radio is scanning

Radio registered: LEDs light to indicate the RSSI level at the device.

	RSSI > -60 dBm		-70 dBm < RSSI ≤ -60 dBm		-80 dBm < RSSI ≤ -70 dBm		RSSI ≤ -80 dBm
---	----------------	---	--------------------------	---	--------------------------	---	----------------

## FORCE 130 SPECIFICATIONS

The Force 130 module conforms to the specifications listed in [Table 39](#) and [Table 40](#).

The device meets the low level static discharge specifications identified in [Electromagnetic compatibility \(EMC\) compliance](#) on page [428](#) and provides internal surge suppression but does not provide lightning suppression.

For a full listing of Force 130 specifications, see [Force 130 website](#).

**Table 38** Force 130 physical and environmental specifications

Category	Specification
Dimensions (H x W x D)	235 x 77 x 58 mm
Weight	0.35 kg (0.88 lbs)
Surge Suppression	1 Joule Integrated
Environment	IP55
Temperature	-30°C to +55°C (-22°F to +122°F)
Power consumption	8 W Maximum, 5 W Typical
Input Voltage	24 V; uses standard passive PoE injectors at 24V. Not compatible with 29V supplies

**Table 39** Force 130 Performance and Security specifications

Category	Specification
ARQ	Yes
Nominal Receive Sensitivity (w/FEC) @20 MHz Channel	MCS0 -88 dBm to MCS15 = -70 dBm at MCS7 for 20 MHz
Nominal Receive Sensitivity (w/FEC) @40 MHz Channel	MCS0 = -86 dBm to MCS15 = -68 dBm at MCS7 for 40 MHz
Modulation Levels(Adaptive)	MCS0 (BPSK) to MCS15 (64QAM 5/6)
Quality of Service	Three level priority (Voice, High, Low) with packet classification by DSCP, COS, VLAN ID, IP & MAC Address, Broadcast, Multicast and Station Priority
Transmit Power Range	+3 to 31 dBm (combined, to regional EIRP limit) (1 dB interval)
Antenna Gain	12 dBi
Security Encryption	128-bit AES (CCMP mode)

**Table 40** Force 130 Antenna specifications

Category	Specification
Frequency Range	2402 – 2472 MHz
Antenna Type	Flat pane
Peak Gain	12 dBi
3dB Beamwidth-Azimuth	45 degrees
3dB Beamwidth-Elevation	15 degrees

## FORCE 130 SOFTWARE PACKAGES

Force 130 radios may be upgraded by downloading new software packages from the Cambium Networks website or by using the Cambium Network Services Server. The software packages applicable to ePMP Force 130 are named:

- ePMP-NonGPS\_Synced-[version].tar.gz

## Force 180

For details of the ePMP Force 180 hardware, see:

- [Force 180 description](#) on page 70
- [Force 180 part numbers](#) on page 70
- [Force 180 mounting bracket](#) on page 71
- [Force 180 interfaces](#) on page 71
- [Force 180 LEDs](#) on page 72
- [Force 180 heater](#) on page 73
- [Force 180 wind loading](#) on page 73
- [Force 180 software packages](#) on page 74

## FORCE 180 DESCRIPTION

The Force 180 integrated module is a self-contained transceiver unit that houses both radio and networking electronics. An ePMP Force 180 unit may function as an Access Point (AP) or a Subscriber Module (SM) in a Point-To-Multipoint (PMP) or in a Point-To-Point (PTP) network topology. It is typically deployed as an SM in a PMP system.

**Figure 22** ePMP Series Force 180



## FORCE 180 PART NUMBERS

Choose the correct regional variant: one is for use in regions where FCC or IC licensing restrictions apply (FCC/IC), one is for use in ETSI countries (EU), and one is for non-FCC/IC/ETSI-restricted regions (RoW).

Each of the parts listed in [Table 38](#) includes the following items:

- One Force 180 module (with mounting bracket)
- One metal mounting strap
- Power supply

**Table 38** Force 180 part numbers

Cambium description	Cambium part number
ePMP 5 GHz Force 180 Integrated Radio (FCC) (US cord)	C058900C072A
ePMP 5 GHz Force 180 Integrated Radio (ROW) (no cord)	C050900C071A
ePMP 5 GHz Force 180 Integrated Radio (EU) (EU cord)	C050900C073A
ePMP 5 GHz Force 180 Integrated Radio (ROW) (US cord)	C050900C171A
ePMP 5 GHz Force 180 Integrated Radio (ROW) (EU cord)	C050900C271A
ePMP 5 GHz Force 180 Integrated Radio (ROW) (UK cord)	C050900C371A

ePMP 5 GHz Force 180 Integrated Radio (EU) (UK cord)	C050900C373A
ePMP 5 GHz Force 180 Integrated Radio (ROW) (India cord)	C050900C471A
ePMP 5 GHz Force 180 Integrated Radio (ROW) (China cord)	C050900C571A
ePMP 5 GHz Force 180 Integrated Radio (ROW) (Brazil cord)	C050900C671A
ePMP 5 GHz Force 180 Integrated Radio (ROW) (Argentina cord)	C050900C771A
ePMP 5 GHz Force 180 Integrated Radio (ROW) (ANZ cord)	C050900C871A
ePMP 2.4 GHz Force 180 Integrated Radio (ROW) (no cord)	C060900C271A

## FORCE 180 MOUNTING BRACKET

**Figure 23** Force 180 module mounting bracket

The Force 180 module is designed to be pole-mounted using the mounting strap and bracket provided in the box with the radio.



## FORCE 180 INTERFACES

The Force 180 module interfaces are illustrated in **Figure 21** and described in **Table 38**.

**Figure 24** Force 180 interfaces

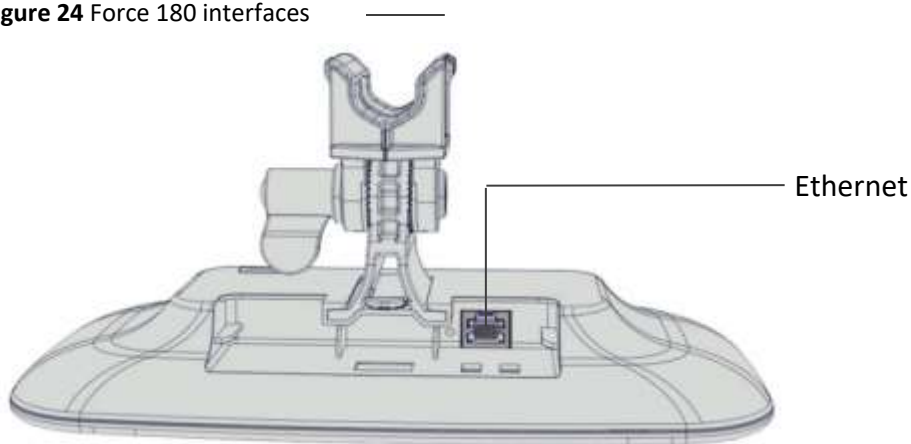

**Table 41** Force 180 interfaces

Port name	Connector	Interface	Description
Ethernet	RJ45	PoE input	10/100/1000BaseT, Compatible with Cambium PoE pinouts (V+ = 7 & 8, Return = 4 & 5) and Standard PoE pinouts (V+ = 4 & 5, Return = 7 & 8)
		10/100/1000 Base-TX Ethernet	Management and data
Reset Button	Physical button	N/A	For resetting the radio and for setting the radio back to its factory default configuration. See <a href="#">Using the device external reset button</a> on page 304.

### FORCE 180 LEDS



LED	Function
POWER	Green: Power is applied to the device Unlit: No power is applied to the device or improper power source
ETH	Ethernet port indicator Once lit, blinking indicates Ethernet activity Green: 10/100/1000 BaseTX link
RF SIGNAL	Radio scanning: LEDs light in an ascending sequence to indicate that the radio is scanning Radio registered: LEDs light to indicate the RSSI level at the device.



### FORCE 180 SPECIFICATIONS

The Force 180 module conforms to the specifications listed in [Table 39](#) and [Table 40](#).

The device meets the low level static discharge specifications identified in [Electromagnetic compatibility \(EMC\) compliance](#) on page 428 and provides internal surge suppression but does not provide lightning suppression.

For a full listing of Force 180 specifications, see [ePMP 1000 website](#).



**Table 42** Force 180 physical specifications

Category	Specification
Dimensions (H x W x D)	Radio: 12.5 x 25.1 x 11.9 cm (4.9 x 9.9 x 4.7 in) – with mounting bracket attached  Radio: 12.5 x 25.1 x 4 cm (4.9 x 9.9 x 1.6 in) – without mounting bracket attached
Weight	0.50 kg (1.1 lbs)

**Table 43** Force 180 environmental specifications

Category	Specification
Temperature	-30°C (-22°F) to +60°C (140°F)
Wind loading	90 mph (145 kph) maximum. See <a href="#">Force 180 wind loading</a> on page 73 for a full description.
Humidity	95% condensing
Environmental	IP55

## FORCE 180 HEATER

Upon power on, if the ePMP Force 180 device temperature is at or below 32° F (0° C), an internal heater is activated to ensure that the device is able to successfully begin operation. The unit's heater is only activated when the unit is powered on and will not apply heat to the device once startup is complete. When the unit temperature is greater than 32° F (0° C), the heater is deactivated and the integrated module continues its startup sequence.

The effect on Force 200 startup time at various temperatures is defined in [Table 41](#).

**Table 44** Force 180 startup times based on ambient temperature

Initial Temperature	Startup time (from power on to operational)
-22° F (-30° C)	4 minutes
-4° F (-20° C)	2 minutes
14° F (-10° C)	1 minutes, 30 seconds

## FORCE 180 WIND LOADING

Ensure that the Force 180 and the structure on which it is mounted are capable of withstanding the prevalent wind speeds at a proposed ePMP site. Wind speed statistics must be available from national meteorological offices.

The Force 180 and its mounting bracket are capable of withstanding wind speeds of up to 145 Kph (90 mph).

Wind blowing on the Force 180 will subject the mounting structure to significant lateral force. The magnitude of the force depends on both wind strength and surface area of the Force 180. Wind loading is estimated using the following formulae:

$$\text{Force (in kilograms)} = 0.1045aV^2$$

Where:

a

surface area in square meters

V

wind speed in meters per second

$$\text{Force (in pounds)} = 0.0042Av^2$$

Where:

A

surface area in square feet

v

wind speed in miles per hour

Applying these formulae to the ePMP Force 180 at different wind speeds, the resulting wind loadings are shown in [Table 42](#) and [Table 43](#).

**Table 45** Force 180 wind loading (Kg)

Type of ePMP module	Largest surface area (square meters)	Wind speed (meters per second)				
		30	40	50	60	70
Force 180	0.031	3 Kg	5.2 Kg	8.2 Kg	11.8 Kg	16 Kg

**Table 46** Force 180 wind loading (lb)

Type of ePMP module	Largest surface area (square feet)	Wind speed (miles per hour)				
		80	100	120	140	150
Force 180	0.33	9 lb	14.1 lb	20.3 lb	27.7 lb	31.8 lb

## FORCE 180 SOFTWARE PACKAGES

Force 180 radios may be upgraded by downloading new software packages from the Cambium Networks website or by using the Cambium Network Services Server. The software packages applicable to ePMP Force 180 are named:

- ePMP-NonGPS\_Synced-[Version].tar.gz

## Force 190

For details of the ePMP Force 190 hardware, see:

- [Force 190 description](#) on page [75](#)
- [Force 190 part numbers](#) on page [75](#)
- [Force 190 mounting bracket](#) on page [77](#)
- [Force 190 interfaces](#) on page [77](#)
- [Force 190 LEDs](#) on page [79](#)
- [Force 190 specifications](#) on page [79](#)
- [Force 190 heater](#) on page [80](#)
- [Force 190 wind loading](#) on page [80](#)
- [Force 190 software packages](#) on page [81](#)

## FORCE 190 DESCRIPTION

Figure 25 ePMP Series Force 190

The Force 190 integrated dish is a self-contained transceiver unit that houses both radio, parabolic dish and networking electronics. An ePMP Force 190 unit may function as an Access Point (AP) or a Subscriber Module (SM) in a Point-To-Multipoint (PMP) or in a Point-To-Point (PTP) network topology. It is typically deployed as an SM in a PMP system and either Master or Slave in a PTP system.



## FORCE 190 PART NUMBERS

Choose the correct regional variant: one is for use in regions where FCC or IC licensing restrictions apply (FCC/IC), one is for use in ETSI countries (EU), and one is for non-FCC/IC/ETSI-restricted regions (RoW).

Each of the parts listed in [Table 44](#) includes the following items:

- Force 190 Radio Assembly

- Power Cord (if applicable)
- Power Supply
- Force 190 Side Reflector Panels (Qty. 2)
- Force 190 Top Reflector Panel
- Force 190 Bottom Reflector Panel
- Force 190 Rear Housing
- Force 190 Pole Mounting Bracket
- Force 190 Pole Clamp

**Table 47** Force 190 part numbers

Cambium description	Cambium part number
ePMP Force 190 5 GHz Subscriber Module (FCC) (US Cord)	C058900C082A
ePMP Force 190 5 GHz Subscriber Module (EU) (EU Cord)	C050900C083A
ePMP Force 190 5 GHz Subscriber Module (EU) (UK Cord)	C050900C873A
ePMP Force 190 5 GHz Subscriber Module (RoW) (No Cord)	C050900C081A
ePMP Force 190 5 GHz Subscriber Module (RoW) (US Cord)	C050900C181A
ePMP Force 190 5 GHz Subscriber Module (RoW) (EU Cord)	C050900C281A
ePMP Force 190 5 GHz Subscriber Module (RoW) (India Cord)	C050900C481A
ePMP Force 190 5 GHz Subscriber Module (RoW) (China Cord)	C050900C581A
ePMP Force 190 5 GHz Subscriber Module (RoW) (Brazil Cord)	C050900C681A
ePMP Force 190 5 GHz Subscriber Module (RoW) (Type-N Plug Cord)	C050900C781A
ePMP Force 190 5 GHz Subscriber Module (RoW) (ANZ Cord)	C050900C881A
ePMP Force 190 5 GHz Subscriber Module (RoW) (No PSU)	C050900C981A

## FORCE 190 MOUNTING BRACKET

**Figure 26** Force 190 mounting bracket (clamp insertion)



The Force 190 module is designed to be pole-mounted using the mounting bracket and clamp assembly provided in the box with the radio.

**Figure 27** Force 190 mounting bracket (clamp securing)



## FORCE 190 INTERFACES

The Force 190 module interfaces are illustrated in [Figure 25](#) and described in [Table 45](#).

**Figure 28** Force 190 interfaces**Table 48** Force 190 interfaces

Port name	Connector	Interface	Description
Ethernet	RJ45	PoE input	10/100/1000BaseT, Compatible with Cambium PoE pinouts (V+ = 7 & 8, Return = 4 & 5) and Standard PoE pinouts (V+ = 4 & 5, Return = 7 & 8)
		10/100 Base-TX Ethernet	Management and data
Reset Button	Physical button	N/A	For resetting the radio and for setting the radio back to its factory default configuration. See <a href="#">Using the device external reset button</a> on page <a href="#">304</a> .

## FORCE 190 LEDS

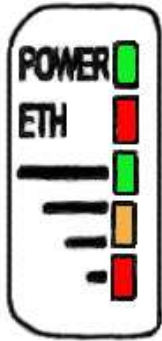

LED	Function
POWER	Green: Power is applied to the device Unlit: No power is applied to the device or improper power source
ETH	Ethernet port indicator Once lit, blinking indicates Ethernet activity Green: 10/100/1000 BaseTX link
RF SIGNAL	Radio scanning: LEDs light in an ascending sequence to indicate that the radio is scanning Radio registered: LEDs light to indicate the RSSI level at the device.



## FORCE 190 SPECIFICATIONS

The Force 190 module conforms to the specifications listed in [Table 46](#) and [Table 47](#).

The device meets the low level static discharge specifications identified in [Electromagnetic compatibility \(EMC\) compliance](#) on page [428](#) and provides internal surge suppression but does not provide lightning suppression.

For a full listing of Force 190 specifications, see [ePMP 1000 website](#).

**Table 49** Force 190 physical specifications

Category	Specification
Dimensions (Dia x Depth)	35 x 28 cm (13.5 x 11.2 in)
Weight	1.0 kg (2.2 lbs)

**Table 50** Force 190 environmental specifications

Category	Specification
Temperature	-30°C (-22°F) to +60°C (140°F) – with radome attached maximum temperature is +47°C (116°F)
Wind loading	70 mph (125 kph) maximum. See <a href="#">Force 190 wind loading</a> on page <a href="#">80</a> for a full description.
Humidity	95% condensing
Environmental	IP55

## FORCE 190 HEATER

Upon power on, if the ePMP Force 190 device temperature is at or below 32° F (0° C), an internal heater is activated to ensure that the device is able to successfully begin operation. The unit’s heater is only activated when the unit is powered on and will not apply heat to the device once startup is complete. When the unit temperature is greater than 32° F (0° C), the heater is deactivated and the Force 190 module continues its startup sequence.

The effect on Force 190 startup time at various temperatures is defined in [Table 48](#).

**Table 51** Force 190 startup times based on ambient temperature

Initial Temperature	Startup time (from power on to operational)
-22° F (-30° C)	4 minutes
-4° F (-20° C)	2 minutes
14° F (-10° C)	1 minutes, 30 seconds

## FORCE 190 WIND LOADING

Ensure that the Force 190 and the structure on which it is mounted are capable of withstanding the prevalent wind speeds at a proposed ePMP site. Wind speed statistics must be available from national meteorological offices.

The Force 190 and its mounting bracket are capable of withstanding wind speeds of up to 125 Kph (70 mph).

Wind blowing on the Force 190 will subject the mounting structure to significant lateral force. The magnitude of the force depends on both wind strength and surface area of the integrated module. Wind loading is estimated using the following formulae:

$$\text{Force (in kilograms)} = 0.1045aV^2$$

Where:

a

V

Is:

surface area in square meters

wind speed in meters per second

$$\text{Force (in pounds)} = 0.0042Av^2$$

Where:

A

v

Is:

surface area in square feet

wind speed in miles per hour

Applying these formulae to the ePMP Force 200 at different wind speeds, the resulting wind loadings are shown in [Table 49](#) and [Table 50](#).

**Table 52** Force 190 wind loading (Kg)

Type of ePMP module	Largest surface area (square meters)	Wind speed (meters per second)				
		30	40	50	60	70
Force 190	0.12	2.8 Kg	7.8 Kg	15.3 Kg	25.4 Kg	37.9 Kg



**Table 53** Force 190 wind loading (lb)

Type of ePMP module	Largest surface area (square feet)	Wind speed (miles per hour)				
		30	50	70	90	110
Force 190	1.05	4 lb	11 lb	21.6 lb	35.7 lb	53.4 lb

## FORCE 190 SOFTWARE PACKAGES

Force 190 radios may be upgraded by downloading new software packages from the Cambium Networks website or by using the Cambium Network Services Server. The software packages applicable to ePMP Force 190 are named:

- ePMP-NonGPS\_Synced-[Version].tar.gz

## Force 200

For details of the ePMP Force 200 hardware, see:

- [Force 200 description](#) on page [82](#)
- [Force 200 part numbers](#) on page [83](#)
- [Force 200 mounting bracket](#) on page [84](#)
- [Force 200 interfaces](#) on page [84](#)
- [Force 200 LEDs](#) on page [86](#)
- [Force 200 heater](#) on page [87](#)
- [Force 200 wind loading](#) on page [87](#)
- [Force 200 software packages](#) on page [88](#)

## FORCE 200 DESCRIPTION

The Force 200 integrated dish is a self-contained transceiver unit that houses both radio, parabolic dish and networking electronics. An ePMP Force 200 unit may function as an Access Point (AP) or a Subscriber Module (SM) in a Point-To-Multipoint (PMP) or in a Point-To-Point (PTP) network topology. It is typically deployed as an SM in a PMP system and either Master or Slave in a PTP system.

**Figure 29** ePMP Series Force 200



**Figure 30** ePMP Series Force 200 (with optional radome – sold separately)



## FORCE 200 PART NUMBERS

Choose the correct regional variant: one is for use in regions where FCC or IC licensing restrictions apply (FCC/IC), one is for use in ETSI countries (EU), and one is for non-FCC/IC/ETSI-restricted regions (RoW).

Each of the parts listed in **Table 51** includes the following items:

- Force 200 Radio Assembly
  - Power Cord (if applicable)
  - Power Supply
- Force 200 Dish
- Force 200 Pole Bracket Assembly
- Force 200 Pole Clamp Assembly
- Four M6 Bolts

**Table 54** Force 200 part numbers

Cambium description	Cambium part number
ePMP 5 GHz Force 200AR5-25 High Gain Radio (FCC) (US cord)	C058900C062A
ePMP 5 GHz Force 200AR5-25 High Gain Radio (ROW) (no cord)	C050900C061A
ePMP 5 GHz Force 200AR5-25 High Gain Radio (EU) (EU cord)	C050900C063A
ePMP 5 GHz Force 200AR5-25 High Gain Radio (ROW) (US cord)	C050900C161A
ePMP 5 GHz Force 200AR5-25 High Gain Radio (ROW) (EU cord)	C050900C261A
ePMP 5 GHz Force 200AR5-25 High Gain Radio (ROW) (UK cord)	C050900C361A
ePMP 5 GHz Force 200AR5-25 High Gain Radio (EU) (UK cord)	C050900C363A
ePMP 5 GHz Force 200AR5-25 High Gain Radio (ROW) (India cord)	C050900C461A
ePMP 5 GHz Force 200AR5-25 High Gain Radio (ROW) (China/ANZ cord)	C050900C561A
ePMP 5 GHz Force 200AR5-25 High Gain Radio (ROW) (Brazil cord)	C050900C661A
ePMP 5 GHz Force 200AR5-25 High Gain Radio (ROW) (Argentina cord)	C050900C761A
ePMP 2.4 GHz Force 200AR2-25 High Gain Radio (US cord)	C024900C161A
ePMP 2.4 GHz Force 200AR2-25 High Gain Radio (EU cord)	C024900C261A
ePMP Force 200 Radome	N000900L021A

## FORCE 200 MOUNTING BRACKET

**Figure 31** Force 200 mounting bracket (side)



The Force 200 module is designed to be pole-mounted using the mounting bracket and clamp assembly provided in the box with the radio.

**Figure 32** Force 200 mounting bracket (back)



## FORCE 200 INTERFACES

The Force 200 module interfaces are illustrated in [Figure 30](#) and described in [Table 52](#).

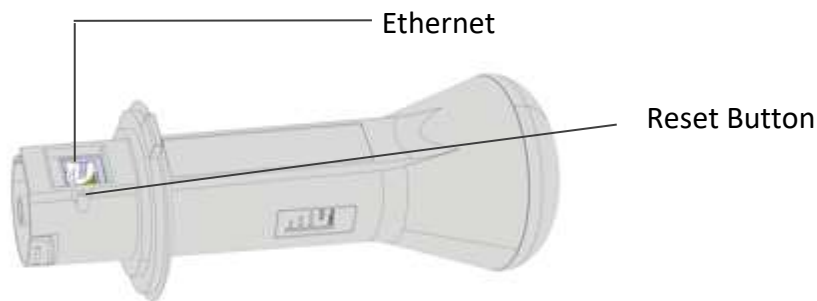
**Figure 33** Force 200 interfaces**Table 55** Force 200 interfaces

Port name	Connector	Interface	Description
Ethernet	RJ45	PoE input	10/100/1000BaseT, Compatible with Cambium PoE pinouts (V+ = 7 & 8, Return = 4 & 5) and Standard PoE pinouts (V+ = 4 & 5, Return = 7 & 8)
		10/100/1000 Base-TX Ethernet	Management and data
Reset Button	Physical button	N/A	For resetting the radio and for setting the radio back to its factory default configuration. See <a href="#">Using the device external reset button</a> on page 304.

## FORCE 200 LEDS

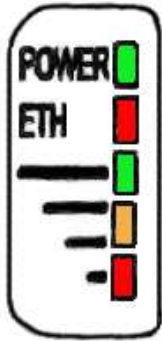

LED	Function
POWER	Green: Power is applied to the device Unlit: No power is applied to the device or improper power source
ETH	Ethernet port indicator Once lit, blinking indicates Ethernet activity Green: 10/100/1000 BaseTX link
RF SIGNAL	Radio scanning: LEDs light in an ascending sequence to indicate that the radio is scanning Radio registered: LEDs light to indicate the RSSI level at the device.



## FORCE 200 SPECIFICATIONS

The Force 200 module conforms to the specifications listed in [Table 53](#) and [Table 54](#).

The device meets the low level static discharge specifications identified in [Electromagnetic compatibility \(EMC\) compliance](#) on page [428](#) and provides internal surge suppression but does not provide lightning suppression.

For a full listing of Force 200 specifications, see [ePMP 1000 website](#).

**Table 56** Force 200 physical specifications

Category	Specification
Dimensions (Dia x Depth)	47 x 28 cm (18.5 x 11.2 in)
Weight	2.4 GHz: 2.8 kg (6.2 lbs) 5 GHz: 2.3 kg (5.1 lbs)

**Table 57** Force

### 200 environmental specifications

Category	Specification
Temperature	-30°C (-22°F) to +60°C (140°F) – with radome attached maximum temperature is +47°C (116°F)
Wind loading	90 mph (145 kph) maximum. See <a href="#">Force 200 wind loading</a> on page <a href="#">87</a> for a full description.
Humidity	95% condensing

---

Environmental IP55

---

## FORCE 200 HEATER

Upon power on, if the ePMP Force 200 device temperature is at or below 32° F (0° C), an internal heater is activated to ensure that the device is able to successfully begin operation. The unit's heater is only activated when the unit is powered on and will not apply heat to the device once startup is complete. When the unit temperature is greater than 32° F (0° C), the heater is deactivated and the Force 200 module continues its startup sequence.

The effect on Force 200 startup time at various temperatures is defined in [Table 55](#).

**Table 58** Force 200 startup times based on ambient temperature

Initial Temperature	Startup time (from power on to operational)
-22° F (-30° C)	4 minutes
-4° F (-20° C)	2 minutes
14° F (-10° C)	1 minutes, 30 seconds

## FORCE 200 WIND LOADING

Ensure that the Force 200 and the structure on which it is mounted are capable of withstanding the prevalent wind speeds at a proposed ePMP site. Wind speed statistics must be available from national meteorological offices.

The Force 200 and its mounting bracket are capable of withstanding wind speeds of up to 145 Kph (90 mph).

Wind blowing on the Force 200 will subject the mounting structure to significant lateral force. The magnitude of the force depends on both wind strength and surface area of the integrated module. Wind loading is estimated using the following formulae:

$$\text{Force (in kilograms)} = 0.1045aV^2$$

Where:

a

V

Is:

surface area in square meters

wind speed in meters per second

$$\text{Force (in pounds)} = 0.0042Av^2$$

Where:

A

v

Is:

surface area in square feet

wind speed in miles per hour

Applying these formulae to the ePMP Force 200 at different wind speeds, the resulting wind loadings are shown in [Table 56](#) and [Table 57](#).

**Table 59** Force 200 wind loading (Kg)

Type of ePMP module	Largest surface area (square meters)	Wind speed (meters per second)				
		30	40	50	60	70
Force 200	0.13	12.3 Kg	22 Kg	34.4 Kg	49.5 Kg	67.4 Kg

**Table 60** Force 200 wind loading (lb)

Type of ePMP module	Largest surface area (square feet)	Wind speed (miles per hour)				
		80	100	120	140	150
Force 200	1.44	38.7 lb	60.4 lb	87 lb	118 lb	136 lb

## FORCE 200 SOFTWARE PACKAGES

Force 200 radios may be upgraded by downloading new software packages from the Cambium Networks website or by using the Cambium Network Services Server. The software packages applicable to ePMP Force 200 are named:

- ePMP-NonGPS\_Synced-[Version].tar.gz



## ePMP 2000 Series Power Supply

For details of the ePMP power supply units, see:

- [Power supply description](#) on page 89
- [Power supply part numbers](#) on page 89
- [Power supply interfaces](#) on page 90
- [Power supply specifications](#) on page 90
- [Power supply location](#) on page 91

### POWER SUPPLY DESCRIPTION

The power supply is an indoor unit that is connected to the ePMP module and network terminating equipment using Cat5e cable with RJ45 connectors. It is also plugged into an AC or DC power supply so that it can inject Power over Ethernet (PoE) into the module.

### POWER SUPPLY PART NUMBERS

Each module requires one power supply and one power supply line cord (line cord included with radio device, see [Table 2](#)). The power supplies listed in [Table 58](#) may be used for all ePMP 2000 modules

**Table 61** Power supply component part numbers

Cambium description	Cambium part number
POWER SUPPLY, 30W, 56V – Gbps support	N000000L034

## POWER SUPPLY INTERFACES

The power supply interfaces are illustrated in **Figure 31** and described in **Table 59** and **Table 60**.

**Figure 34** Power supply interfaces

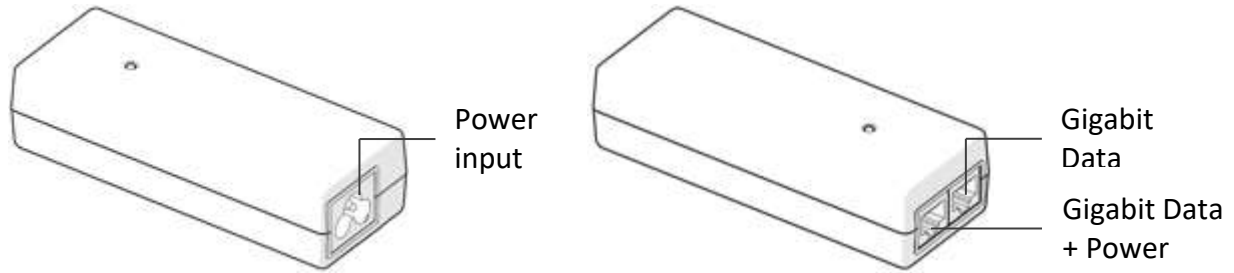

**Table 62** Power supply interface functions - N000000L034

Interface	Function
Power input	Mains power input.
Gigabit Data + Power	RJ45 socket for connecting Cat5e cable to radio
Gigabit Data	RJ45 socket for connecting Cat5e cable to network.

**Table 63** Power Supply LED functions

LED	Function
Power (green)	Power supply detection

## POWER SUPPLY SPECIFICATIONS

The ePMP power supply conforms to the specifications listed in **Table 61**, **Table 62**, and **Table 63**. These specifications apply to ePMP 2000 product variants.

**Table 64** Power supply physical specifications

Category	Specification
Dimensions (H x W x D)	14 x 6.5 x 3.6 cm (5.5 x 2.55 x 1.42 in)
Weight	0.26 lbs

**Table 65** Power supply environmental specifications

Category	Specification
Ambient Operating Temperature	0° C to +40° C
Humidity	20% - 90%

**Table 66** Power supply electrical specifications

Category	Specification
AC Input	100 to 240 VAC
Efficiency	Meets Energy Level 6
Over Current Protection	Short circuit, with auto recovery
Hold up time	10 ms minimum at maximum load, 120 VAC

## POWER SUPPLY LOCATION

Find a location for the power supply that meets the following requirements:

- The power supply can be mounted on a wall or other flat surface.
- The power supply is kept dry, with no possibility of condensation, flooding or rising damp.
- The power supply can be accessed to view status indicators.
- The power supply can be connected to the ePMP module drop cable and network terminating equipment.
- The power supply can be connected to a mains or DC power supply that meets the requirements defined in [Table 70](#).

## ePMP 1000 Series Power Supply (includes Force 180, Force 190, and Force 200)

For details of the ePMP power supply units, see:

- [Power supply description](#) on page 92
- [Power supply part numbers](#) on page 92
- [Power supply interfaces](#) on page 93
- [Power supply specifications](#) on page 94
- [Power supply location](#) on page 94

### POWER SUPPLY DESCRIPTION

The power supply is an indoor unit that is connected to the ePMP module and network terminating equipment using Cat5e cable with RJ45 connectors. It is also plugged into an AC or DC power supply so that it can inject Power over Ethernet (PoE) into the module.

### POWER SUPPLY PART NUMBERS

Each module requires one power supply and one power supply line cord (line cord included with radio device, see [Table 11](#), [Table 20](#), [Table 28](#), [Table 37](#), [Table 51](#)). The power supplies listed in [Table 64](#) may be used for all ePMP 1000 modules, however, only N000900L001B provides a Gigabit Ethernet interface.

**Table 67** Power supply component part numbers

Cambium description	Cambium part number
ePMP Pwr Supply for GPS Radio - no cord (spare)	N000900L001B
ePMP Pwr Supply for non-GPS Radio - no cord (spare)	N000900L002A
ePMP Pwr Supply for Force 190 – no cord (spare)	N000900L003A

## POWER SUPPLY INTERFACES

The power supply interfaces are illustrated in **Figure 32** and described in **Table 65** and **Table 67**.

**Figure 35** Power supply interfaces

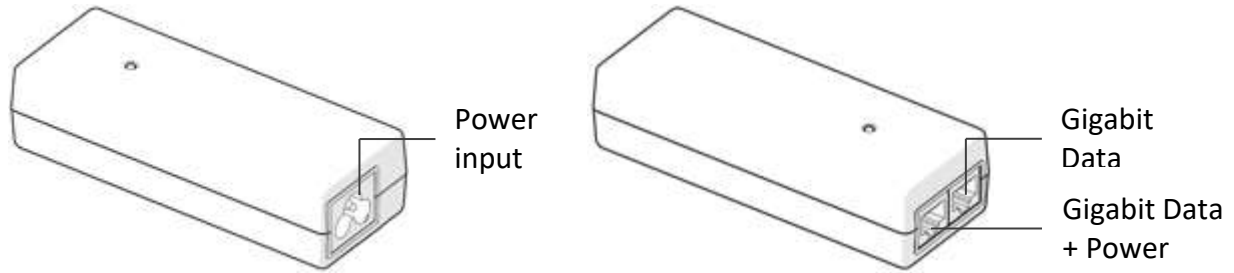

**Table 68** Power supply interface functions - N000900L001B

Interface	Function
Power input	Mains power input.
Gigabit Data + Power	RJ45 socket for connecting Cat5e cable to radio <div style="border: 1px solid #ccc; padding: 5px; margin-top: 10px;">  <b>Note</b>                          This port provides a Gigabit Ethernet interface to ePMP GPS Synced connectorized radios. To ePMP integrated radios, this port provides a 10/100 Mbit/sec Ethernet interface.                     </div>
Gigabit Data	RJ45 socket for connecting Cat5e cable to network.

**Table 69** Power supply interface functions - N000900L002A, N000900L003A

Interface	Function
Power input	Mains power input.
10/100 Mbit/sec Data + Power	RJ45 socket for connecting Cat5e cable to radio
10/100 Mbit/sec Data	RJ45 socket for connecting Cat5e cable to network.

**Table 70** Power Supply LED functions

LED	Function
Power (green)	Power supply detection

## POWER SUPPLY SPECIFICATIONS

The ePMP power supply conforms to the specifications listed in [Table 68](#), [Table 69](#) and [Table 70](#). These specifications apply to all ePMP product variants.

**Table 71** Power supply physical specifications

Category	Specification
Dimensions (H x W x D)	11.8 x 4.4 x 3.2 cm (4.66 x 1.75 x 1.25 in)
Weight	0.26 lbs

**Table 72** Power supply environmental specifications

Category	Specification
Ambient Operating Temperature	0° C to +40° C
Humidity	20% - 90%

**Table 73** Power supply electrical specifications

Category	Specification
AC Input	100 to 240 VAC
Efficiency	Meets efficiency level 'V'
Over Current Protection	Zener clamping (38V to 45V)
Hold up time	10 ms minimum at maximum load, 120 VAC

## POWER SUPPLY LOCATION

Find a location for the power supply that meets the following requirements:

- The power supply can be mounted on a wall or other flat surface.
- The power supply is kept dry, with no possibility of condensation, flooding or rising damp.
- The power supply can be accessed to view status indicators.
- The power supply can be connected to the ePMP module drop cable and network terminating equipment.
- The power supply can be connected to a mains or dc power supply that meets the requirements defined in [Table 70](#).

## Ethernet cabling

For details of the Ethernet cabling components of an ePMP installation, see:

- [Ethernet standards and cable lengths](#) on page 95
- [Outdoor Cat5e cable](#) on page 95

## ETHERNET STANDARDS AND CABLE LENGTHS

All configurations require a copper Ethernet connection from the power supply port to the power supply and network terminating equipment.

For each power supply, the maximum permitted drop cable length is specified in [Table 71](#).

**Table 74** Power supply drop cable length restrictions

Part number	Description	Maximum cable length (*1)
N000000L034	POWER SUPPLY, 30W, 56V – Gbps support	330 feet (100m)
N000900L001B	Power Supply for Radio with Gigabit Ethernet (no cord)	330 feet (100m)
N000900L002A	Power Supply for Radio with 100Mbit Ethernet (no cord)	330 feet (100m)

(\*1) Maximum length of Ethernet cable from AP/SM to network device needs to follow 802.3 standards. If the power supply is not the network device the cable from the power supply to the network device must be included in the total maximum cable length.

## OUTDOOR CAT5E CABLE

### *Cambium Industrial Cable*

Cambium Industrial Cable uses 24 gauge solid bare copper conductors, covered by bonded-pair polymer insulation. The conductors are protected by double layer shielding consisting of a solid foil layer under braided tinned copper mesh, providing excellent shielding while maximizing flexibility. And, the cable is jacketed by industrial grade UV-resistant, abrasion-resistant, and oil-resistant PVC.

Cambium's Industrial RJ45 connectors are specifically designed to work optimally with Cambium Industrial Cable.

The connectors are fully shielded with integrated strain relief for greater pull strength, utilize a staggered contact design that minimizes crosstalk and maximizes electrical performance, and the contacts are plated with 50 micro-inch thick 24 carat gold, exceeding TIA-1096 specifications and ensuring the best possible connection and oxidation resistance.

Cambium Networks' industrial grade cable is well suited for high-quality durable installations of subscriber modules, access points and enterprise point-to-point links as well as in tactical non-permanent deployments of infrastructure.

**Table 75** Cambium Industrial Ccable component part numbers

Cambium description	Cambium part number
Industrial Grade CAT 5 Cable 50 meter unterminated	N000000L106A

---

Industrial Grade CAT 5 Cable 100 meter unterminated	N000000L106A
Industrial Grade CAT 5 Cable 300 meter unterminated	N000000L108A
Industrial Grade RJ45 Connector 100 Pack	C000000L109A
Termination Tool for C000000L109A RJ45 connectors	C000000L110A

---



## Surge suppression unit

Structures, equipment and people must be protected against power surges (typically caused by lightning) by conducting the surge current to ground via a separate preferential solid path.

The actual degree of protection required depends on local conditions and applicable local regulations. To adequately protect an ePMP installation, both ground bonding and transient voltage surge suppression are required.

Network operators should always follow best-practices for grounding and lightning protection. Doing so will minimize network outages and reduce the associated costs of tower climbs and equipment repair/replacement.



### Note

Lightning-prone installations can be improved by:

1. Installing a 600SS surge suppressor near the device (transient surge suppression)
2. Grounding the device to the pole (ground bonding)
3. Lowering the device/dish such that it is not the highest metallic object on the pole

## GIGABIT ETHERNET SURGE SUPPRESSOR

The Gigabit Ethernet Surge Suppressor is critical for lightning protection to minimize the potential for damage.

**Table 76** Surge suppressor component part numbers

Cambium description	Cambium part number
Gigabit Surge Suppressor (30V)	C000000L065A
Gigabit Surge Suppressor (56V)	C000000L033A



### Note

Choose the 30V or 56V surge suppressor option based on your installed device power rating. Installing a 30V surge suppressor for a 56V device or a 56V surge suppressor for a 30V device may result in inadequate surge protection.

30V ePMP installations with Ethernet connections that require only a 100 Mbit/sec connection may also be protected with the Cambium Networks 600SSH surge suppressor.

## System planning

This chapter provides information to help the user to plan an ePMP link.

The following topics are described in this chapter:

- How to plan ePMP links to conform to the regulatory restrictions that apply in the country of operation is explained under **Radio spectrum planning** on page **99**.
- Factors to be considered when planning links such as range, path loss and throughput are described under **Link planning** on page **103**.
- Factors to be considered when planning to use connectorized APs with external antennas in ePMP links are described under **Planning for connectorized units** on page **104**.
- The grounding and lightning protection requirements of a ePMP installation are described under **Grounding and lightning protection** on page **32**.
- Factors to be considered when planning ePMP data networks are described under **Data network planning** on page **106**.

## Radio spectrum planning

This section describes how to plan ePMP links to conform to the regulatory restrictions that apply in the country of operation.



Caution

The user must ensure ePMP product operates in accordance to local regulatory limits.



Note

Contact the applicable radio regulator to check if registration of the ePMP link is required.

## GENERAL WIRELESS SPECIFICATIONS

The wireless specifications that apply to all ePMP variants are listed under [Table 74](#). The wireless specifications that are specific to each frequency variant are listed in [Table 75](#) and [Table 76](#).

**Table 77** ePMP wireless specifications (all variants)

Item	Specification
Channel selection	Automatic and Manual selection (fixed frequency).
Manual power control	To avoid interference to other users of the band, maximum power can be set lower than the default power limit.
Integrated device antenna type	Patch antenna
Duplex scheme	Adaptive TDD (with optional Standard 802.11n Wi-Fi on SM)
Range	21 mi (5 MHz channel bandwidth) 17 mi (10 MHz channel bandwidth) 13 mi (20 MHz channel bandwidth) 9 mi (40 MHz channel bandwidth)
Over-the-air encryption	AES
Error Correction	FEC

**Table 78** ePMP 2000 wireless specifications (per frequency band)

Item	5 GHz
RF band (GHz)	5150 - 5970 MHz
Channel bandwidth	5 MHz, 10 MHz, 20 MHz or 40 MHz
Typical antenna gain	Connectorized antenna – 18 dBi

**Table 79** ePMP 1000 wireless specifications (per frequency band)

Item	2.4 GHz	2.5 GHz	5 GHz
------	---------	---------	-------

RF band (GHz)	2407 - 2472 MHz	2570 - 2620 MHz	4900 - 5980 MHz
Channel bandwidth	5 MHz, 10 MHz, 20 MHz or 40 MHz	5 MHz, 10 MHz, 20 MHz or 40 MHz	5 MHz, 10 MHz, 20 MHz or 40 MHz
Typical antenna gain	Connectorized antenna - 15 dBi Integrated patch antenna - 11 dBi Reflector dish antenna – 8 dBi	Connectorized antenna - 15 dBi Reflector dish antenna – 8 dBi	Connectorized antenna – 15 dBi Integrated patch antenna – 13 dBi Reflector dish antenna – 6 dBi
Antenna beamwidth (Integrated)	24° azimuth, 12° elevation	24° azimuth, 12° elevation	24° azimuth, 12° elevation
Antenna beamwidth (Reflector dish)	10° azimuth, 28° elevation	10° azimuth, 28° elevation	10° azimuth, 25° elevation

## REGULATORY LIMITS

The local regulator may restrict frequency usage and channel width and may limit the amount of conducted or radiated transmitter power. For details of these restrictions, see [Examples of regulatory limits](#) on page 445.

Many countries impose EIRP limits (Allowed EIRP) on products operating in the bands used by the ePMP Series. For example, in the 5 GHz and 2.4 GHz bands, these limits are calculated as follows:

- In the 5.2 GHz (5250 MHz to 5350 MHz) and 5.4 GHz (5470 MHz to 5725 MHz) band, the EIRP must not exceed the lesser of 30 dBm or  $(17 + 10 \times \text{Log Channel width in MHz})$  dBm.
- In the 5.8 GHz band (5725 MHz to 5875 MHz), the EIRP must not exceed the lesser of 36 dBm or  $(23 + 10 \times \text{Log Channel width in MHz})$  dBm.
- In the 2.4 GHz band (2400 MHz to 2500 MHz), the EIRP must not exceed the lesser of 36 dBm or  $(23 + 10 \times \text{Log Channel width in MHz})$  dBm.

Some countries (for example the USA) impose conducted power limits on products operating in the 5 GHz and 2.4 GHz band.

## CONFORMING TO THE LIMITS

Ensure the link is configured to conform to local regulatory requirements by configuring the correct country code (located in the web management interface, under **Configure** => **Radio**). In the following situations, the country code does not automatically prevent operation outside the regulations:

- When using connectorized APs with external antennas, the regulations may require the maximum transmit power to be reduced. To ensure that regulatory requirements are met for connectorized installations, see [Calculating maximum power level for connectorized units](#) on page 104. When operating in ETSI regions, it is required to enter a license key in the ePMP web management interface to unlock valid country-specific frequencies. This key may be obtained from <https://support.cambiumnetworks.com/licensekeys/epmp>.
- When installing 5.4 GHz links in the USA, it may be necessary to avoid frequencies used by Terminal Doppler Weather Radar (TDWR) systems. For more information, see [Avoidance of weather radars](#) on page 101.

## AVAILABLE SPECTRUM

The available spectrum for operation depends on the region. When configured with the appropriate country code, the unit will only allow operation on those channels which are permitted by the regulations.



#### Note

In Italy, there is a regulation which requires a general authorization of any 5.4 GHz radio link which is used outside the operator's own premises. It is the responsibility of the installer or operator to have the link authorized. For details, see:

[http://www.sviluppoeconomico.gov.it/index.php?option=com\\_content&view=article&idmenu=672&idarea1=593&andor=AND&idarea2=1052&id=68433&sectionid=1,16&viewType=1&showMenu=1&showCat=1&idarea3=0&andor cat=AND&partebassaType=0&idareaCalendario1=0&MvediT=1&idarea4=0&showArchiveNewsBotton=0&directionidUser=0](http://www.sviluppoeconomico.gov.it/index.php?option=com_content&view=article&idmenu=672&idarea1=593&andor=AND&idarea2=1052&id=68433&sectionid=1,16&viewType=1&showMenu=1&showCat=1&idarea3=0&andor cat=AND&partebassaType=0&idareaCalendario1=0&MvediT=1&idarea4=0&showArchiveNewsBotton=0&directionidUser=0)

For the form that must be used for general authorization, see:

[http://www.sviluppoeconomico.gov.it/images/stories/mise\\_extra/Allegato%20n19.doc](http://www.sviluppoeconomico.gov.it/images/stories/mise_extra/Allegato%20n19.doc)

Certain regulations have allocated certain channels as unavailable for use:

- ETSI has allocated part of the 5.4 GHz band to weather radar.
- Some European countries have allocated part of the 5.8 GHz band to Road Transport and Traffic Telematics (RTTT) systems.

For details of these restrictions, see Examples of regulatory limits on page [445](#).

Where regulatory restrictions apply to certain channels, these channels are barred automatically by the use of the correct country code. For example, in some European countries the RTTT band 5795 MHz to 5815 MHz is barred. With the appropriate country code configured for this region, the ePMP will not operate on channels within this band.

The number and identity of channels barred by the license key and country code is dependent on the channel bandwidth.

For more information about configuring the **Country Code** parameter, see [AP Radio page](#) on page [134](#) and [SM Radio page](#) on page [202](#).

## CHANNEL BANDWIDTH

Select the required channel bandwidth for the link. The selection depends upon the ePMP frequency variant and country code, as specified on page [445](#).

The wider a channel bandwidth the greater is its capacity. As narrower channel bandwidths take up less spectrum, selecting a narrow channel bandwidth may be a better choice when operating in locations where the spectrum is very busy.

Both ends of the link must be configured to operate on the same channel bandwidth.

## AVOIDANCE OF WEATHER RADARS

To comply with FCC rules (KDB 443999: Interim Plans to Approve UNII Devices Operating in the 5470 - 5725 MHz Band with Radar Detection and DFS Capabilities), units which are installed within 35 km (22 miles) of a Terminal Doppler Weather Radar (TDWR) system (or have a line of sight propagation path to such a system) must be configured to avoid any frequency within +30 MHz or -30 MHz of the frequency of the TDWR device. This requirement applies even if the master is outside the 35 km (22 miles) radius but communicates with outdoor clients which may be within the 35 km (22 miles) radius of the TDWRs.

The requirement for ensuring 30 MHz frequency separation is based on the best information available to date. If interference is not eliminated, a distance limitation based on line-of-sight from TDWR will need to be used. In addition, devices with bandwidths greater than 20 MHz may require greater frequency separation.

When planning a link in the USA, visit <http://spectrumbridge.com/udia/home.aspx>, enter the location of the planned link and search for TDWR radars. If a TDWR system is located within 35 km (22 miles) or has line of sight propagation to the PMP device, perform the following tasks:

- Register the installation on <http://spectrumbridge.com/udia/home.aspx>.

- Make a list of channel center frequencies that must be barred, that is, those falling within +30 MHz or –30 MHz of the frequency of the TDWR radars.

In ETSI regions, the band 5600 MHz to 5650 MHz is reserved for the use of weather radars.

## Link planning

This section describes factors to be taken into account when planning links, such as range, obstacles path loss and throughput.

### RANGE AND OBSTACLES

Calculate the range of the link and identify any obstacles that may affect radio performance.

Perform a survey to identify all the obstructions (such as trees or buildings) in the path and to assess the risk of interference.

This information is necessary in order to achieve an accurate link feasibility assessment.

### PATH LOSS

Path loss is the amount of attenuation the radio signal undergoes between the two ends of the link. The path loss is the sum of the attenuation of the path if there were no obstacles in the way (Free Space Path Loss), the attenuation caused by obstacles (Excess Path Loss) and a margin to allow for possible fading of the radio signal (Fade Margin). The following calculation needs to be performed to judge whether a particular link can be installed:

$$L_{free\_space} + L_{excess} + L_{fade} + L_{seasonal} < L_{capability}$$

Where:

Is:

$L_{free\_space}$	Free Space Path Loss (dB)
$L_{excess}$	Excess Path Loss (dB)
$L_{fade}$	Fade Margin Required (dB)
$L_{seasonal}$	Seasonal Fading (dB)
$L_{capability}$	Equipment Capability (dB)

Free space path loss is a major determinant in received (Rx) signal level. Rx signal level, in turn, is a major factor in the system operating margin (fade margin), which is calculated as follows:

$$\text{System Operating Margin (fade margin) dB} = \text{Rx signal level (dB)} - \text{Rx sensitivity (dB)}$$

Thus, the fade margin is the difference between strength of the received signal and the strength that the receiver requires for maintaining a reliable link.

### ADAPTIVE MODULATION

Adaptive modulation ensures that the highest throughput that can be achieved instantaneously will be obtained, taking account of propagation and interference. When the link has been installed, web pages provide information about the link loss currently measured by the equipment, both instantaneously and averaged.

## Planning for connectorized units

This section describes factors to be taken into account when planning to use connectorized APs with external antennas in ePMP networks.

### CALCULATING MAXIMUM POWER LEVEL FOR CONNECTORIZED UNITS

If a connectorized ePMP link is to be installed in a country that imposes an EIRP limit in the selected band, choose an external antenna and RF cable that will not cause the ePMP to exceed the EIRP limit. To calculate the highest setting of Maximum Power Level that will be permitted, use this formula:

$$\text{Maximum Power Level (dBm)} = \text{Allowed EIRP (dBm)} - \text{Antenna Gain (dBi)} + \text{Cable Loss (dB)}$$

Where:	Is:
Maximum Power Level (dBm)	the highest permissible setting of the Maximum Power Level attribute in the Step 2: Wireless Configuration page,
Allowed EIRP (dBm)	the EIRP limit allowed by the regulations,
Antenna Gain (dBi)	the gain of the chosen antenna,
Cable Loss (dB)	the loss of the RF cable connecting the AP to the antenna.

As the 2.4 GHz, 2.5 GHz, 5.4 GHz and 5.8 GHz have an operating bandwidth of 5 MHz, 10 MHz, 20 MHz or 40 MHz then the maximum allowed EIRP depends on the operating bandwidth of the radio as shown in [Table 77](#).

**Table 80** Normal EIRP limits with operating channel bandwidth

Operating bandwidth (MHz)	Allowed EIRP (dBm) at 2.4 GHz	Allowed EIRP (dBm) at 2.5 GHz	Allowed EIRP (dBm) at 5.2 GHz	Allowed EIRP (dBm) at 5.4 GHz	Allowed EIRP (dBm) at 5.8 GHz
5, 10, 20, 40	36	N/A	24 - 30	24 - 30	36

The settings to be used for regions with the EIRP limits in [Table 77](#) are shown in [Table 78](#).

**Table 81** Setting maximum transmit power to meet general EIRP limits

Antenna	Maximum available antenna gain (dBi)	Operating bandwidth (MHz)	Transmitter Output Power parameter setting (dBm)				
			2.4 GHz	2.5 GHz	5.2 GHz	5.4 GHz	5.8 GHz
ePMP 2000 Conn. module Sector antenna	18	5, 10, 20, 40	N/A	N/A	12	12	18
ePMP 1000 Conn. module Sector antenna	15	5, 10, 20, 40	21	27	15	15	21



**Note**

Calculations under **Table 78** are on the basis of 0.5 dB cable loss and the highest gain antennas per size of which Cambium Networks are aware. At these operating frequencies, antenna cable losses even with short cables are unlikely to ever be below 0.5 dB for practical installations and cable diameters.

## Data network planning

This section describes factors to be considered when planning ePMP data networks.

### ETHERNET INTERFACES

The ePMP Ethernet ports conform to the specifications listed in [Table 79](#) and [Table 80](#).

**Table 82** ePMP 2000 Ethernet bridging specifications

Ethernet Bridging	Specification
Protocol	10BASE-T <sub>e</sub> /100BASE-T <sub>x</sub> /1000BASE-T IEEE 802.3 IEEE 802.3at (PoE) IEEE802.3u compliant Auto-negotiation
QoS	Proprietary QoS
Interface	10/100/1000BaseT (RJ-45)
Data Rates	See <a href="#">Data throughput tables</a> on page <a href="#">477</a> .
Maximum Ethernet Frame Size	1700 bytes
Service classes for bridged traffic	3 classes

**Table 83** ePMP 1000 Ethernet bridging specifications

Ethernet Bridging	Specification
Protocol	10BASE-T <sub>e</sub> /100BASE-T <sub>x</sub> /1000BASE-T IEEE 802.3 IEEE 802.3af (PoE) IEEE802.3u compliant Auto-negotiation
QoS	Proprietary QoS
Interface	10/100/1000BaseT (RJ-45)
Data Rates	See <a href="#">Data throughput tables</a> on page <a href="#">477</a> .
Maximum Ethernet Frame Size	1700 bytes
Service classes for bridged traffic	3 classes

**Note**

Practical Ethernet rates will depend on network configuration, higher layer protocols and platforms used.

Over the air throughput will be capped to the rate of the Ethernet interface at the receiving end of the link.

## MANAGEMENT VLAN

Decide if the IP interface of the AP/SM management agent will be connected in a VLAN. If so, decide if this is a standard (IEEE 802.1Q) VLAN or provider bridged (IEEE 802.1ad) VLAN, and select the VLAN ID for this VLAN.

Use of a separate management VLAN is strongly recommended. Use of the management VLAN helps to ensure that the AP/SM management agent cannot be accessed by customers.

## QUALITY OF SERVICE FOR BRIDGED ETHERNET TRAFFIC

Decide how quality of service will be configured in ePMP to minimize frame loss and latency for high priority traffic. Wireless links often have lower data capacity than wired links or network equipment like switches and routers, and quality of service configuration is most critical at network bottlenecks.

ePMP provides three priority types for traffic waiting for transmission over the wireless link – Voice, High and Low. Low is the lowest priority and Voice is the highest priority. Traffic is scheduled using strict priority; in other words, traffic in a given priority is transmitted when all higher-priority transmissions are complete.

## Configuration

This chapter describes all configuration and alignment tasks that are performed when an ePMP system is deployed.

Configure the units by performing the following tasks:

- **Preparing for configuration** on page **109**
- **Using the web interface** on page **112**
- **Configuring connectorized radios using the Quick Start menu** on page **125**
- **Configuring SM units using the Quick Start menu** on page **128**
- **Using the AP menu options** on page **132**
- **Using the SM menu options** on page **200**

## Preparing for configuration

This section describes the checks to be performed before proceeding with unit configuration.

### SAFETY PRECAUTIONS

All national and local safety standards must be followed while configuring the units.



#### Warning

Ensure that personnel are not exposed to unsafe levels of RF energy. The units start to radiate as soon as they are powered up. Respect the safety standards defined in **Compliance with safety standards** on page **426**, in particular the minimum separation distances.

Observe the following guidelines:

Never work in front of the antenna when the AP is powered. Always power down the power supply before connecting or disconnecting the Ethernet cable from the module.

### REGULATORY COMPLIANCE

All applicable radio regulations must be followed while configuring the units and aligning the antennas. For more information, **Compliance with safety standards** on page **428**.

## Connecting to the unit

To connect the unit to a management PC, use the following procedures:

- **Configuring the management PC** on page 110
- **Connecting to the PC and powering up** on page 111

## CONFIGURING THE MANAGEMENT PC

Use this procedure to configure the local management PC to communicate with the ePMP module.

### Procedure:

- 1 Select **Properties** for the Ethernet port.

In Windows 7 this is found in Control Panel > Network and Internet > Network Connections > Local Area Connection.

- 2 Select the Internet Protocol (TCP/IP) item:

- 3 Click Properties.

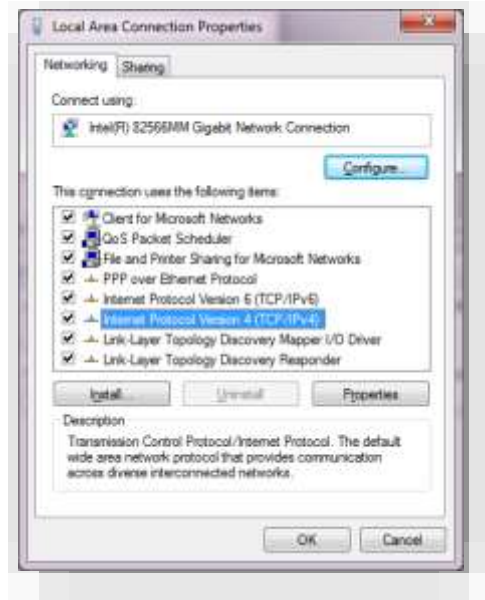

- 4 Enter an IP address that is valid for the 192.168.0.X network, avoiding:

192.168.0.1, 192.168.0.2 and 192.168.0.3

A good example is 192.168.0.100:

- 5 Enter a subnet mask of 255.255.255.0.

Leave the default gateway blank.

- 6 Click OK, then click Close



## CONNECTING TO THE PC AND POWERING UP

Use this procedure to connect a management PC directly to the ePMP for configuration and alignment purposes and to power up the ePMP device.

### Procedure:

- 1 Check that the device and power supply are correctly connected (the device Ethernet port is connected to the power supply Ethernet power port).
- 2 Connect the PC Ethernet port to the LAN (AP: "Gigabit Data", SM: "10/100Mbit Data") port of the power supply using a standard (not crossed) Ethernet cable.
- 3 Apply mains or battery power to the power supply. The green Power LED must illuminate continuously.



### Note

If the Power and Ethernet LEDs do not illuminate correctly, see [Testing hardware](#) on page [300](#).

## Using the web interface

To understand how to use the ePMP web interface, see:

- [Logging into the web interface](#) on page **113**
- [Layout of the web interface](#) on page **113**
- [Configuring connectorized radios using the Quick Start menu](#) on page **125**
- [Configuring SM units using the Quick Start menu](#) on page **128**
- [Using the AP menu options](#) on page **132**



## LOGGING INTO THE WEB INTERFACE

Use this procedure to log into the web interface as a system administrator.

Equipment and tools:

- Connectorized or integrated device connected to power supply by Ethernet cable.
- PC connected to power supply by Ethernet cable.
- Power Supply powered up.
- Minimum supported browser version – Chrome v29, Firefox v24, Internet Explorer 10, Safari v5.

### Procedure:

- 1 Start the web browser from the management PC.
- 2 Type the IP address of the unit into the address bar. The factory default IP address is either 192.168.0.1 (AP mode) or 192.168.0.2 (SM mode). Press **ENTER**. The web interface dashboard and login input is displayed.



Note

If **Device IP address Mode** is set to **DHCP** and the device is unable to retrieve IP address information via DHCP, the device management IP is set to fallback IP 192.168.0.1 (AP mode), 192.168.0.2 (SM mode), 192.168.0.3 (Spectrum Analyzer mode) or the previously-configured static Device IP Address. Units may always be accessed via the Ethernet port. With Release 2.1, the fallback IP address has changed from 10.1.1.254 to 169.254.1.1.

- 3 Enter **Username** (default: admin) and **Password** (default: admin).
- 4 Click **Login**.



Note

New ePMP devices all contain default username and password configurations. It is recommended to change these password configurations immediately. These passwords may be configured in the management GUI in section **Configuration => System => Account Management**.

## LAYOUT OF THE WEB INTERFACE

After logging in, the web interface first displays a dashboard view of vital system status and statistics. Also, the first level of navigation is displayed across the top (**Configure, Monitor, Tools** and **Quick Start**).

Figure 36 ePMP 2000 GUI dashboard (includes additional fields not resident in ePMP 1000)

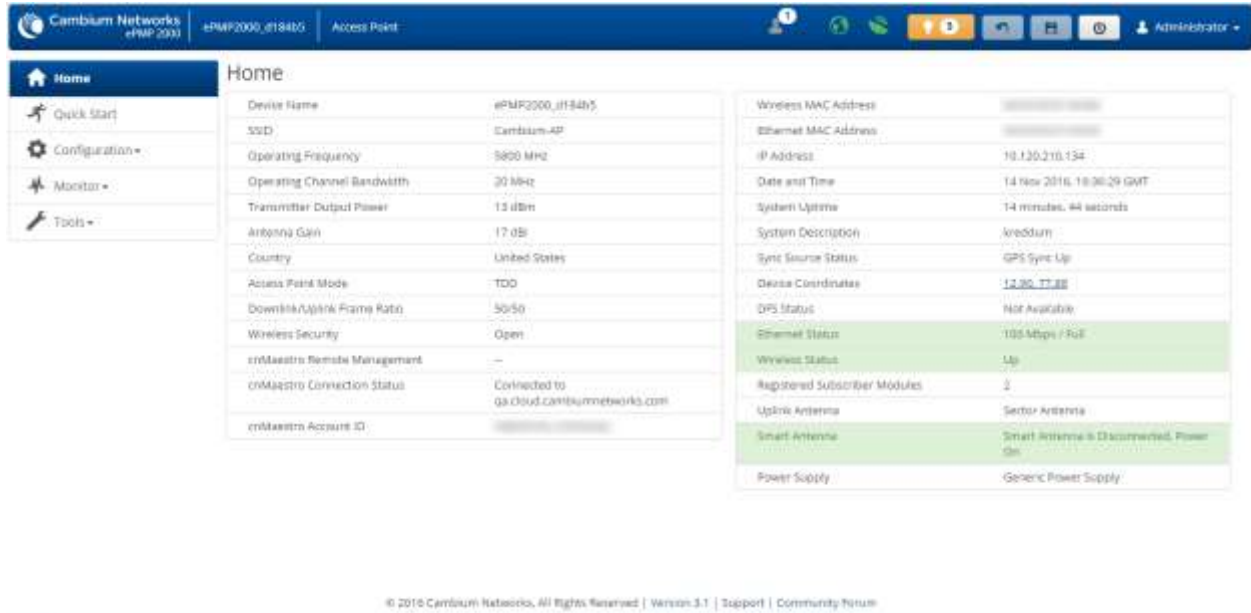
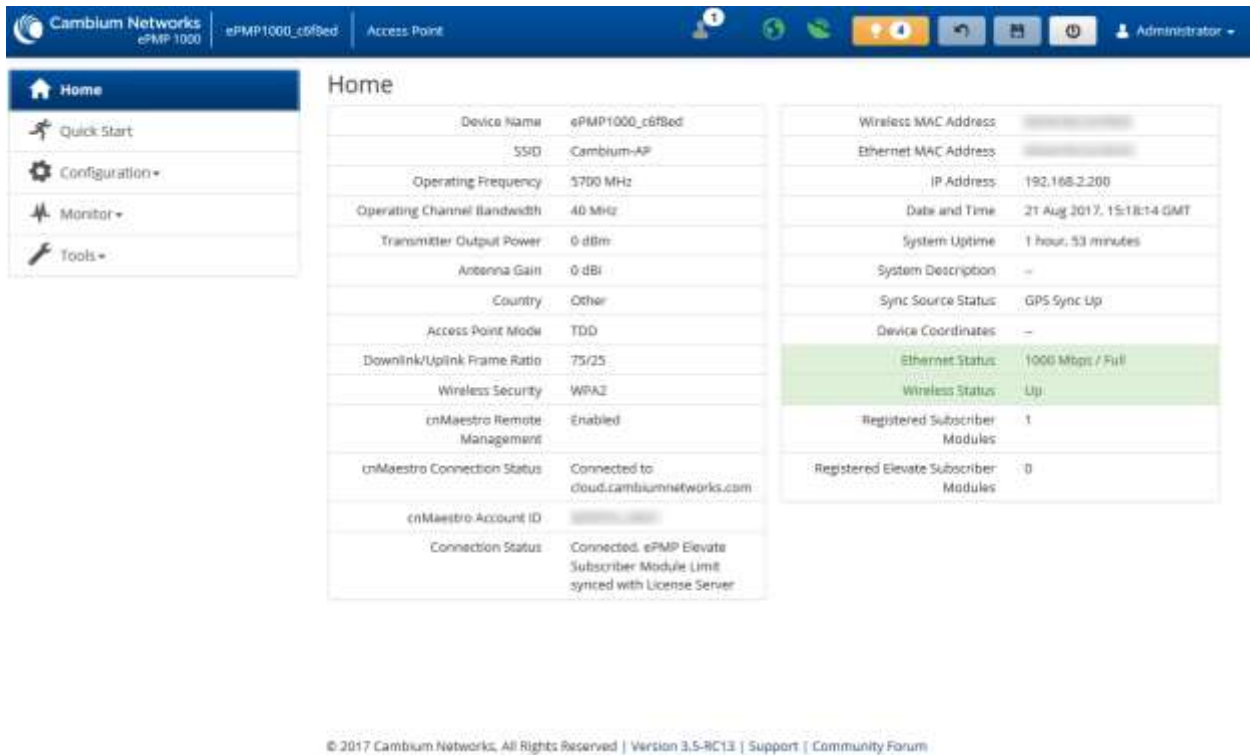



Figure 37 ePMP 1000 GUI dashboard



The top of the interface contains the following attributes:

**Table 84** GUI status bar attributes

Icon	Attribute	Meaning
	Cambium Networks logo	Hyperlink to the Cambium Networks website.
	Login Level indicator	Displays the current user login level.
	Internet Connectivity Indicator	<p><b>Green</b> indicates that the AP has IP connectivity to the configured DNS server.</p> <p><b>Grey</b> indicates that the AP has no IP connectivity to the configured DNS server.</p> <p> Note</p> <p>The Internet Connectivity Indicator state is determined by receipt of ping responses from the configured DNS server.</p>
	GPS Synchronization Receive Indicator	<p><b>Green</b> indicates that the AP is receiving a valid GPS synchronization timing pulse via a connected GPS antenna or a CMM.</p> <p><b>Red</b> indicates that the AP is not receiving GPS synchronization due to lack of satellite fix.</p> <p><b>Grey</b> indicates that the AP is not receiving GPS synchronization due to configuration of <b>Synchronization Source</b> to <b>Internal</b>.</p>
	Notifications Button	<p>The Notifications button may be clicked to display system messaging. When a new notification is available, the icon is highlighted and displays the number of notifications available. The outer icon highlighting indicates the type of notification pending:</p> <p><b>Green:</b> Successful operation has completed (i.e. Changes successfully saved)</p> <p><b>Grey:</b> Informational message (i.e. tips regarding GUI operation)</p> <p><b>Blue:</b> Operations information message (i.e. Initializing upgrade...)</p> <p><b>Orange:</b> Warning message (i.e. Login session has expired)</p> <p><b>Red:</b> Error message (i.e. Software update file download failed)</p>
	Active Users Indicator	When the mouse pointer is hovered over this indicator, it displays the number of active Read-Only and Read-Write users currently logged into the radio.
	Undo Button	The Undo button may be used to undo changes prior to a Save operation. All changes made on any section of the GUI are undone.
	Save Button	The Save button is used to commit configuration changes to the device. When configuration changes are made, the outer area of the icon is highlighted blue to indicate that a save operation is required.

Icon	Attribute	Meaning
	Reset Button	The Reset button is used to reset the device. When a configuration change requires a radio reset, the outer area of this icon is highlighted orange to indicate that a reset is necessary to complete the change.
	Logout Button	The Logout button is used to logout from the current session and return to the initial GUI landing page (login screen).

The bottom of the interface contains the following attributes:

**Table 85** GUI footer attributes

Attribute	Meaning
Copyright	Copyright information.
Version	The current software version is reported in the footer bar and may be clicked to navigate to the Cambium Networks software support website.
Support	Hyperlink to the Cambium Networks support website.
Community Forum	Hyperlink to the Cambium Community Forum website.

The AP dashboard contains the following attributes:

**Table 86** AP dashboard attributes

Attribute	Meaning
Device Name	The configured device name of the AP, used for identifying the device in an NMS such as the Cambium Network Services Server (CNSS).
SSID	The current configured name/SSID of the AP.
Operating Frequency	The current frequency carrier used for radio transmission, based on the configuration of the <b>Frequency Carrier</b> parameter (in DFS regions, if a radar has been detected, this field may display either <b>DFS Alternate Frequency Carrier 1</b> or <b>DFS Alternate Frequency Carrier 2</b> ).
Operating Channel Bandwidth	The current channel bandwidth used for radio transmission, based on the configuration of the <b>Channel Bandwidth</b> parameter.
Transmitter Output Power	The current operating transmit power of the AP.
Antenna Gain	The configured gain of the external antenna.
Country	The current configured country code, which has an effect on DFS operation and transmit power restrictions. Registered Subscriber Modules will inherit this country code when registration is complete (unless SM is locked to US region).

Attribute	Meaning
Access Point Mode	<p><b>TDD:</b> The Access Point is operating in point-to-multipoint (PMP) mode using TDD scheduling. The AP is able to GPS synchronize in this mode (except when in Flexible mode).</p> <p><b>ePTP Master:</b> The Access Point is operating as a Master in point-to-point mode. The AP does not support GPS Synchronization in this mode but is able to provide <b>significantly lower latency</b> than other modes. QoS (MIR and traffic priority) capability and Link Quality/Capacity indicators are not available in this mode.</p> <p><b>PTP:</b> The Access Point is operating in point-to-point (PTP) mode using TDD scheduling. The AP is able to GPS synchronize in this mode (except when in Flexible mode).</p>
Downlink/Uplink Frame Ratio	The current configured schedule of downlink traffic to uplink traffic on the radio link. In other words, this ratio represents the amount of the total radio link's aggregate throughput that will be used for downlink resources and the amount of the total radio link's aggregate throughput that will be used for uplink resources.
Wireless Security	The current configured authentication type used for radio link encryption as well as SM authentication.
cnMaestro Remote Management	Indicates whether the device is currently configured to be managed by the Cambium cloud management system – <i>cnMaestro</i> <sup>™</sup> .
cnMaestro Connection Status	The current management status of the device with respect to the Cambium Cloud Server. When Enabled under Configuration->System, the device will be managed by the Cambium Remote Management System, which allows all Cambium devices to be managed from the Cambium Cloud Server.
cnMaestro Account ID	The ID that the device is currently using to be managed by the Cambium Cloud Server.
Wireless MAC Address	The MAC address of the device wireless interface.
Ethernet MAC Address	The MAC address of the device Ethernet (LAN) interface.
IP Address	The current configured device IP address (LAN) used for management access.
IPv6 Link Local Address	A link-local address is required for the IPv6-enabled interface (applications may rely on the link-local address even when there is no IPv6 routing). The IPv6 link-local address is comparable to the auto-configured IPv4 address 169.254.0.0/16.
IPv6 Address	The IPv6 address for device management.
Date and Time	The current date and time on the device, subject to the configuration of parameter <b>Time Zone</b> .
System Uptime	The total uptime of the radio since the last reset.
System Description	The current configured system description.
Sync Source Status	Displays the current source (GPS, CMM or Internal) of sync timing for the AP.
Device Coordinates	The current configured Latitude and Longitude coordinates in decimal format.
DFS Status	Current DFS operational status.

Attribute	Meaning
Ethernet Status	<p><b>Up:</b> The Ethernet (LAN) interface is functioning properly. This also displays the current port speed and duplex mode to which the Ethernet port has auto-negotiated to or configured for.</p> <p><b>Down:</b> The Ethernet (LAN) interface is either disconnected or it has encountered an error and is not servicing traffic.</p>
Wireless Status	<p><b>Up:</b> The radio (WAN) interface is functioning properly</p> <p><b>Down:</b> The radio (WAN) interface has encountered an error and is not servicing traffic.</p>
Registered Subscriber Modules	The total number of SMs currently registered to the AP.
Smart Antenna (ePMP 2000 only)	<p>Beginning with Software Release 3.4, the ePMP 2000 unit automatically detects when the Smart Antenna is connected or disconnected (without requiring a reboot).</p> <p><b>Smart Antenna is Connected, Power On:</b> ePMP 2000 is communicating with the Smart Antenna, and a proper power supply is in use</p> <p><b>Smart Antenna is Connected, Power Off:</b> ePMP 2000 established communication with the Smart Antenna, but subsequent communication errors occurred or an improper power supply was detected</p> <p><b>Smart Antenna is Disconnected:</b> Communication between ePMP 2000 and Smart Antenna is down</p>
Power Supply	<p>This field indicates the type of power supply being used to power ePMP 2000. Values are <b>802.3at</b> and <b>Generic Power Supply</b>.</p> <p>The Cambium Power Supply provided with ePMP 2000 will be displayed as "Generic Power Supply". If a different power supply is used and "Generic Power Supply" is indicated, please make sure that the power supply wattage is a minimum of 20 watts.</p>

The SM dashboard is as shown in **Figure 35** and the attributes are explained in **Table 84**.

**Figure 38** SM Dashboard

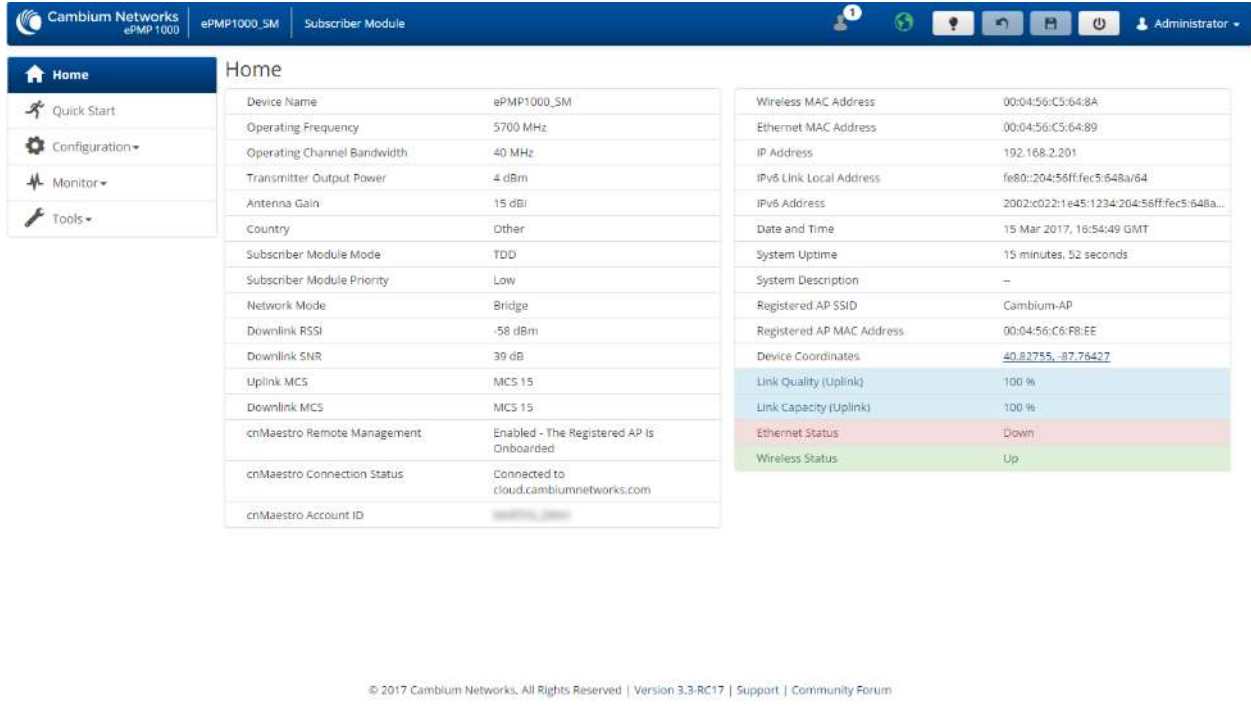

**Table 87** SM Dashboard Attributes

Attribute	Meaning
Device Name	The configured device name of the SM, used for identifying the device in an NMS such as the Cambium Network Services Server (CNSS).
Operating Frequency	The current operating frequency.
Operating Channel Bandwidth	The current operating width of the channel used for the radio link.
Transmitter Output Power	The current power level at which the SM is transmitting (which is adjusted dynamically by the AP based on radio conditions).
Antenna Gain	The configured gain of the external antenna.
Country	The current configured country code, which has an effect on DFS operation and transmit power restrictions. Registered Subscriber Modules will inherit this country code when registration is complete (unless SM is locked to US region).

Attribute	Meaning
Subscriber Module Mode	<p><b>TDD:</b> The SM is operating in the proprietary TDD mode and will only connect to another ePMP Access Point.</p> <p><b>Standard WiFi:</b> The SM is operating in the Standard 802.11n WiFi mode and will be able to connect to any Access Point operating in standard WiFi mode.</p> <p><b>ePTP Slave:</b> The SM is operating as a Slave in point-to-point mode. The AP and the system do not support GPS Synchronization in this mode but are able to provide <b>significantly lower latency</b> than other modes. QoS (MIR and traffic priority) capability and Link Quality/Capacity indicators are not available in this mode.</p>
Subscriber Module Priority	The configured priority of the SM in the sector.
Network Mode	<p><b>Bridge:</b> The SM acts as a switch, and packets are forwarded or filtered based on their MAC destination address.</p> <p><b>NAT:</b> The SM acts as a router, and packets are forwarded or filtered based on their IP header (source or destination) which can be grouped into subnets for finer granularity.</p> <p><b>Router:</b> The SM acts as a router and packets are forwarded or filtered based on their IP header (source or destination) using specific static routes and IP aliases configured by the operator.</p>
Downlink RSSI	The Received Signal Strength Indicator, which is a measurement of the power level being received by the SM's antenna.
Downlink SNR	The Signal to Noise Ratio, which is an expression of the carrier signal quality with respect to signal noise and co-channel interference (or both).
Uplink MCS	Modulation and Coding Scheme – indicates the modulation mode used for the radio uplink, based on radio conditions (MCS 1-7, 9-15).
Downlink MCS	Modulation and Coding Scheme – indicates the modulation mode used for the radio downlink, based on radio conditions (MCS 1-7, 9-15).
cnMaestro Remote Management	Indicates whether the device is currently configured to be managed by the Cambium cloud management system – <i>cnMaestro™</i> .
cnMaestro Connection Status	The current management status of the device with respect to the Cambium Cloud Server. When Enabled under Configuration->System, the device will be managed by the Cambium Remote Management System, which allows all Cambium devices to be managed from the Cambium Cloud Server.
cnMaestro Account ID	The ID that the device is currently using to be managed by the Cambium Cloud Server.
Wireless MAC Address	The MAC address of the device Wireless interface.
Ethernet MAC Address	The MAC address of the device LAN (Ethernet) interface.
IP Address	The current configured device IP address (LAN, Ethernet interface) used for management access.
IPv6 Link Local Address	A link-local address is required for the IPv6-enabled interface (applications may rely on the link-local address even when there is no IPv6 routing). The IPv6 link-local address is comparable to the auto-configured IPv4 address 169.254.0.0/16.



Attribute	Meaning
IPv6 Address	The IPv6 address for the device when the device is used in Bridge mode. This is the IPv6 address for the subnet associated with the Ethernet interface when the device is used in NAT and Router modes.
Wireless IP Address	The current configured device IP address (Wireless interface), when the SM is in Router (NAT) mode.
Separate Wireless Management IP Address	The current configured device IP address (Separate Wireless Management interface) used for management access, when the SM is in Router (NAT) mode.
Date and Time	The current date and time on the device, subject to the configuration of parameter <b>Time Zone</b> . If an NTP server is not specified, the date and time will begin from factory default upon radio startup.
System Uptime	The total uptime of the radio since the last reset.
System Description	The current configured system description.
Registered AP SSID	The AP SSID of the AP to which the SM is registered.
Registered AP MAC Address	The Wireless MAC Address of the AP to which the SM is registered.
Device Coordinates	The current configured Latitude and Longitude coordinates in decimal format.
DFS Status	Current DFS operational status.
Link Quality (Uplink)	The Uplink quality based on the current MCS and Packet Error Rate (PER).
Link Capacity (Uplink)	The uplink capacity based on the current MCS with respect to the highest supported MCS (MCS15).
Ethernet Status	<b>Up:</b> The Ethernet (LAN) interface is functioning properly. This also displays the current port speed and duplex mode to which the Ethernet port has auto-negotiated to or configured for. <b>Down:</b> The Ethernet (LAN) interface is either disconnected or it has encountered an error and is not servicing traffic.
Wireless Status	<b>Up:</b> The radio (WAN) interface is functioning properly. <b>Down:</b> The radio (WAN) interface has encountered an error and is not servicing traffic.

## ePMP Device Configuration Parameters - Default Values

The following tables may be referenced for listings of default configuration values for ePMP device parameters.

Each factory default procedure will return the device to the values listed in the tables below.

**Table 88** AP Ethernet Interface, Configuration Defaults

Attribute	Default Value
IP Assignment	DHCP
IP Address	192.168.0.1 (Default IP Address)
Subnet Mask	255.255.255.0
Management Access	Ethernet
Ethernet MTU	1500 bytes
Port Setting	Auto-Negotiate
VLANs	Disabled
Spanning Tree Protocol	Disabled
SM Traffic Isolation	Disabled
DHCP Option 82	Disabled
LLDP	Enabled(Receive and Transmit)

**Table 89** AP Wireless Interface, Configuration Defaults

Attribute	Default Value
Driver Mode	TDD
Country Code	None / United States / Generic ETSI (ROW / FCC / ETSI device type, respectively) ROW devices do not transmit with Country Code set to None
Default SSID	Cambium-AP
ACS	Enabled
Channel Bandwidth	20 MHz
Downlink/Uplink Ratio	Flexible
Frame Size	5 ms
Max Range	3 Miles
Max Registrations Allowed	10/120 (Lite Devices / Full Capacity Devices, respectively)
Subscriber Module Receive Level	-60/-55 (ePMP 1000 / ePMP 2000, respectively)
Downlink Max Range	MCS15

Attribute	Default Value
Management Traffic Rate	MCS1
Colocation Mode	Disabled
Synchronization Mode	Disabled
Uplink Antenna Selection	Auto (ePMP 2000 with Smart Antenna only)

**Table 90** AP Security Parameters, Configuration Defaults

Attribute	Default Value
WPA2 Security	Enabled (default value <code>Cam39-Tai!wdmv</code> )
L2/L3 Firewall	Disabled
Wireless MAC Address Filtering	Disabled
SNMPv2	Enabled (with default Community Strings) Read-Only Community String – <code>public</code> Read-Write Community String – <code>private</code> Trap Community String – <code>cambiumtrap</code>

**Table 91** SM Ethernet Interface, Configuration Defaults

Attribute	Default Value
Network Mode	Bridge
IP Assignment	DHCP
IP Address	192.168.0.2 (Default IP Address)
Subnet Mask	255.255.255.0
Ethernet MTU	1500 bytes
Port Setting	Auto-negotiate
Management VLAN	Disabled
Data VLAN	Disabled
Membership VLANs	Disabled
IPv6	Disabled
ARP-NAT	Disabled
Spanning Tree Protocol	Disabled
DHCP Server Below SM	Disabled
LLDP	Enabled (Receive and Transmit)

Attribute	Default Value
Ethernet Port Security	Disabled

**Table 92** SM Wireless Interface, Configuration Defaults

Attribute	Default Value
Driver Mode	TDD
Country Code	Follow AP / United States (ROW, ETSI devices / FCC devices, respectively)
Scanning List	All available frequencies selected for 20 MHz and 40 MHz channel bandwidths
Network Entry RSSI Threshold	-90 dBm
Network Entry SNR Threshold	0 dB
Uplink Max Rate	MCS15
Uplink Antenna Selection	Auto (5 GHz SMs only)
Max Tx Power	Auto (Automatic Transmit Power Control and Regulatory-controlled)

**Table 93** SM Security, Configuration Defaults

Attribute	Default Value
RADIUS	Enabled (default EAP-TTLS credentials username: <code>subscriber1</code> , password: <code>cambium</code> )
WPA2	Enabled (default value <code>Cam39-Tai!wdmv</code> )
L2/L3 Firewall	Disabled
SNMPv2	Enabled (with default Community Strings) Read-Only Community String – <code>public</code> Read-Write Community String – <code>private</code> Trap Community String – <code>cambiumtrap</code>

## Configuring connectorized radios using the Quick Start menu

The **Quick Start** tab contains a listing of parameters required to configure a simple radio link and to configure requisite networking parameters. After configuring an AP, SM and resetting both devices, the SM is ready to associate (register) to the AP.

**Figure 39** AP Quick Start menu

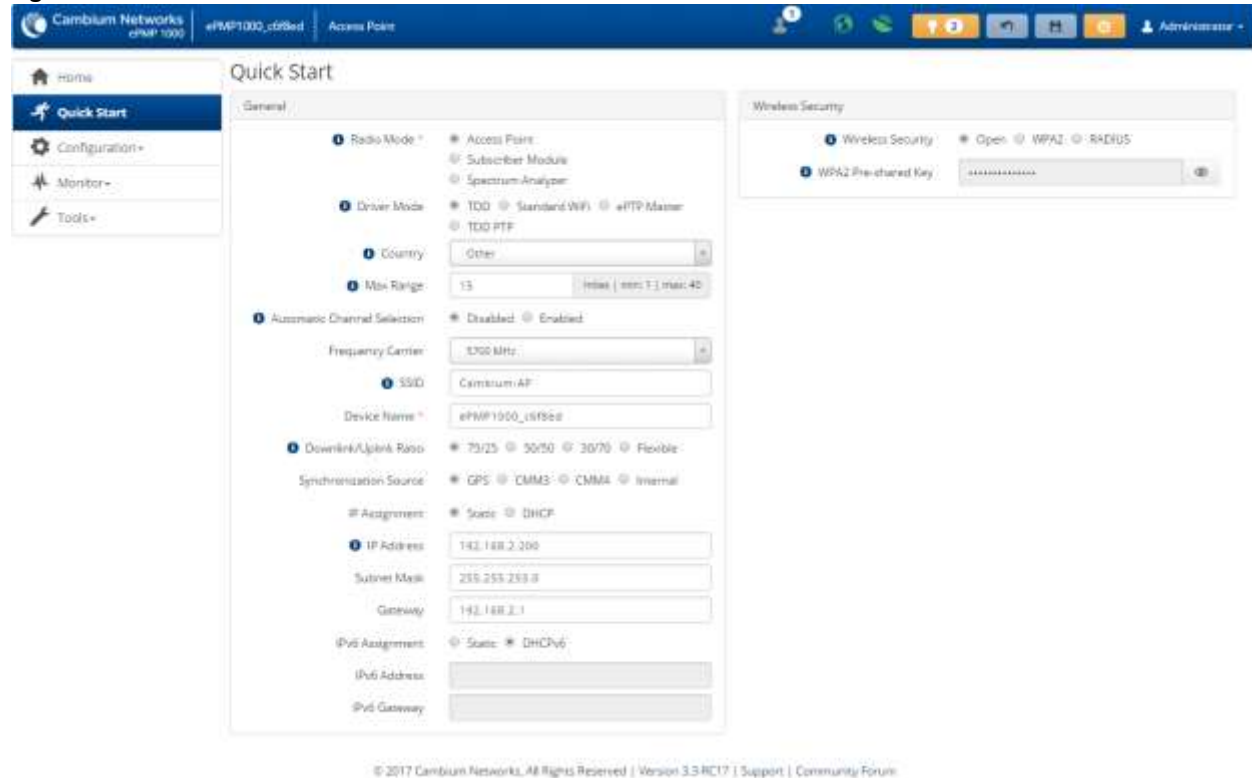

To configure an AP via the Quick Start menu, follow this procedure:

### Procedure:

- 1 Start the web browser from the management PC.
- 2 Navigate to the **Quick Start** menu
- 3 Configure the parameter **Radio Mode**:  
 This parameter controls the function of the device – All ePMP devices may be configured to operate as an Access Point (AP), Subscriber Module (SM) or as a Spectrum Analyzer. For initial link bring-up, choose **Access Point**.
- 4 Configure the parameter **Access Point Mode**:  
 This parameter controls the mode of operation of the Access Point – An AP may be configured to operate in TDD mode for multipoint access, PTP mode for point-to-point access using TDD, Standard WiFi or as an ePTP Master. For initial link bring-up, choose **TDD**. When the AP is an **ePTP Master**, the system does not support GPS Synchronization but is able to provide **significantly lower latency** than other modes. QoS (MIR and traffic priority) capability and Link Quality/Capacity indicators are not available in this mode. Configuring the AP in **Standard WiFi** mode allows any 802.11 client to register to the AP.

**5** Configure the parameter **Country**:

**Country** settings affect the radios in the following ways:

- Maximum transmit power limiting (based on radio transmitter power plus configured antenna gain)
- DFS operation is enabled based on the configured country code, if applicable
- Frequency selection limiting (based on valid frequencies for the configured **Country**)

Select the country in which your network will be operating.

**6** Configure the parameter Automatic Channel Selection (ACS):

When ACS is enabled, the AP will automatically scan the available spectrum and choose a channel with the lowest occupancy. For more information on this parameter please see [AP Automatic Channel Selection page](#) on page 192.

**7** Configure the parameter **Frequency Carrier**:

Configure the frequency carrier for RF transmission. This list is dynamically adjusted to the regional restrictions based on the setting of the **Country Code** parameter. Ensure that a thorough spectrum analysis has been completed prior to configuring this parameter.

**8** Configure parameter **AP SSID (Name)**:

The **AP SSID (Name)** is used to identify the AP and is used to configure the SM with the appropriate AP with which to register. Ensure that this parameter is configured uniquely for each AP in the network.

**9** Configure the parameter **Downlink/Uplink Ratio**:

Specify the percentage of the aggregate throughput for the downlink (frames transmitted from the AP to the SM). For example, if the aggregate (uplink and downlink total) throughput on the AP is 90 Mbps, then 75/25 specified for this parameter allocates 67.5 Mbps for the downlink and 22.5 Mbps for the uplink. The default for this parameter is 75/25.



Caution

You must set this parameter exactly the same for all APs in a cluster.

**10** Configure the parameter **Synchronization Source**:

This parameter defines the timing source for the device which can be GPS-based or internally generated. Select **GPS** if the AP will receive synchronization pulses from a connected GPS antenna. Select **CMM3** or **CMM4** if the device will receive GPS synchronization pulses from a co-located Cambium Cluster Management Module (see *PMP Synchronization Solutions User Guide*). Select **Internal** if no GPS synchronization source is available (in this mode, transmission between co-located devices will create radio interference). If **Flexible** is chosen as the **DL/UL Ratio** or if the **Access Point Mode** is chosen as **ePTP Master**, then this parameter will be greyed out.

**11** Configure the parameter **IP Assignment**:

If **DHCP** is selected, the DHCP server automatically assigns the IP configuration (Ethernet (LAN) IP Address, Ethernet (LAN) IP Subnet Mask, Gateway IP Address (LAN)) and the values of those individual parameters (below) are not used. To configure a simple test network, select mode **Static**.

**12** Configure the parameter **IP address**:

Internet Protocol (IP) address. This address is used by the family of Internet protocols to uniquely identify this unit on a network. To configure a simple test network, this field may be left at default (192.168.0.1).

**13** Configure the parameter **Subnet Mask**:

The Subnet Mask defines the address range of the connected IP network. To configure a simple test network, this field may be left at default (255.255.255.0).

**14** Configure the parameter **Gateway**:

The IP address of the device on the current network that acts as a gateway. A gateway acts as an entrance and exit to packets from and to other networks. To configure a simple test network, this parameter may be left at default (blank).

**15** Configure the parameter **IPv6 Assignment**

**IPv6 Assignment** specifies how the IPv6 address is obtained.

**Static:** Device management IP addressing is configured manually in fields IPv6 Address and IPv6 Gateway.

**DHCPv6:** Device management IP addressing (IP address and gateway) is assigned via a network DHCP server, and parameters **IPv6 Address** and **IPv6 Gateway** are unused. If the DHCPv6 server is not available previous static IPv6 address will be used as a fallback IPv6 address. If no previous static IPv6 address is available, no IPv6 address will be assigned. DHCPv6 will occur over the wireless interface by default.

**16** Configure the parameter **IPv6 Address**

**Internet protocol version 6 (IPv6) address. This address is used by the family of Internet protocols to uniquely identify this unit on a network.**

**IPv6 addresses are represented by eight groups of four hexadecimal digits separated by colons.**

**17** Configure the parameter **IPv6 Gateway**

**Configure the IPv6 address of the device on the current network that acts as a gateway. A gateway acts as an entrance and exit to packets from and to other networks.**

**18** Configure the parameter **WPA2 Pre-shared Key**

Configure this key on the AP and then configure each of the network SMs with this key to complete the authentication configuration. This key must be between 8 to 128 symbols. Click the visibility icon  to toggle the display of the key's contents.

**19** Click the **Save** icon, then click the **Reset** icon

## Configuring SM units using the Quick Start menu

The **Quick Start** tab contains a simple listing of parameters required to configure a simple radio link and to configure requisite networking parameters.

**Figure 40** SM Quick Start menu

To configure a SM via the **Quick Start** menu, follow this procedure:

### Procedure:

- 1 Start the web browser from the management PC.
- 2 Navigate to **Quick Start** menu
- 3 Configure the parameter **Radio Mode**:

This parameter controls the function of the device – all ePMP devices may be configured to operate as an Access Point (AP), Subscriber Module (SM), or as a Spectrum Analyzer. For initial link bring-up, choose **Subscriber Module**.



**4** Configure the parameter **Subscriber Module Mode**:

This parameter controls the mode of operation of the Subscriber Module – An SM may be configured to operate in **TDD** mode for point-to-point and point-to-multipoint access, **Standard WiFi** mode providing the capability to connect to any AP operating in standard WiFi mode or as an **ePTP Slave**. For initial link bring-up, choose **TDD**. When the SM is an **ePTP Slave**, the system does not support GPS Synchronization but is able to provide **significantly lower latency** than other modes. QoS (MIR and traffic priority) capability and Link Quality/Capacity indicators are not available in this mode.

**5** The **Country** is automatically retrieved from the AP and requires no configuration.

**Country** settings affect the radios in the following ways:

- Maximum transmit power limiting (based on radio transmitter power plus configured antenna gain)
- DFS operation is enabled based on the configured country code, if applicable
- Frequency range of operation depending on local limitations

**6** Configure the parameter **Device Name**:

The SM Device Name is used to identify the device on the network. This parameter may be modified or left at the default value of **Cambium-SM**.

**7** Configure the parameter **Network Mode**:

**Bridge**: The SM acts as a switch, and packets are forwarded or filtered based on their MAC destination address.

**NAT**: The SM acts as a router, and packets are forwarded or filtered based on their IP header (source or destination) which can be grouped into subnets for finer granularity.

**Router**: The SM acts as a router and packets are forwarded or filtered based on their IP header (source or destination) using specific static routes and IP aliases configured by the operator.

**8** Configure the parameter **Wireless IP Assignment**:

If **DHCP** is selected, the DHCP server automatically assigns the IP configuration (Ethernet (LAN) IP Address, Ethernet (LAN) IP Subnet Mask, Gateway IP Address (LAN)) and the values of those individual parameters (below) are not used. To configure a simple test network, this parameter must be configured to **Static**.

**9** Configure the parameter **Wireless IP Address**:

Internet Protocol (IP) address. This address is used by the family of Internet protocols to uniquely identify this unit on a network. To configure a simple test network, this field must be configured to 192.168.0.2.

**10** Configure the parameter **Wireless Subnet Mask**:

The Subnet Mask defines the address range of the connected IP network. To configure a simple test network, this field may be left at default (255.255.255.0).

**11** Configure the parameter **Wireless Gateway**:

The IP address of the device on the current network that acts as a gateway. A gateway acts as an entrance and exit to packets from and to other networks. To configure a simple test network, this parameter may be left at default (blank).

**12 Configure the parameter IPv6 Assignment**

IPv6 Assignment specifies how the IPv6 address is obtained.

**Static:** Device management IP addressing is configured manually in fields IPv6 Address and IPv6 Gateway.

**DHCPv6:** Device management IP addressing (IP address and gateway) is assigned via a network DHCP server, and parameters **IPv6 Address** and **IPv6 Gateway** are unused. If the DHCPv6 server is not available previous static IPv6 address will be used as a fallback IPv6 address. If no previous static IPv6 address is available, no IPv6 address will be assigned. DHCPv6 will occur over the wireless interface by default.

**13 Configure the parameter IPv6 Address**

**Internet protocol version 6 (IPv6) address. This address is used by the family of Internet protocols to uniquely identify this unit on a network.**

IPv6 addresses are represented by eight groups of four hexadecimal digits separated by colons.

**14 Configure the parameter IPv6 Gateway**

Configure the IPv6 address of the device on the current network that acts as a gateway. A gateway acts as an entrance and exit to packets from and to other networks.

**15 Configure the parameter WPA2 Pre-shared Key:**

Configure each of the network SMs with this key (matching the AP's configured key) to complete the authentication

configuration. This key must be between 8 to 128 symbols. Click the visibility icon  to toggle the display of the key's contents.

**16 Configure the parameter EAP-TTLS Username:**

Configure each of the network SMs with this EAP-TTLS Username (matching the credentials on the RADIUS server being used for the network). Optionally, the device MAC Address can be used as the EAP-TTLS Username in either ":" or "-" delimited format.

**17 Configure the parameter EAP-TTLS Password:**

Configure each of the network SMs with this EAP-TTLS Password (matching the credentials on the RADIUS server being

used for the network). Click the visibility icon  to toggle the display of the password's contents.

**18 Configure the parameter Authentication Identity String:**

Configure each of the network SMs with this Identity string (matching the credentials on the RADIUS server being used for the network). Default value for this parameter is "anonymous".

**19 Configure the parameter Authentication Identity Realm:**

Configure each of the network SMs with this Identity realm (matching the credentials on the RADIUS server being used for the network). Default value for this parameter is "cambiumnetworks.com".

**20 Configure the Preferred AP's**

The **Preferred AP's** is comprised of a list of up to 16 APs to which the SM sequentially attempts registration. For each AP configured, if authentication is required, enter a **Pre-shared Key** associated with the configured **AP SSID**. If this list is empty or if none of the configured APs are found, the SM scans and registers to the best AP signal found (with matching radio and/or authentication settings).

**21** Configure the parameter Subscriber Module Scanning:

The Radio Scan List determines the frequencies for which the SM scans for AP signaling. For a simple radio network setup, click **Select All** to scan all frequencies.

**22** Click the **Save** icon, then click the **Reset** icon

## Using the AP menu options

Use the menu navigation bar in the top and left panels to navigate to each web page. The functional areas that may be accessed from each menu option are listed in **Table 91**. Some of the parameters are only displayed for specific system configurations.

**Table 94** Functional areas accessed from each AP menu option

Menu option	Menu Details
Quick Start	<b>Configuring connectorized radios using the Quick Start menu</b> on page <b>125</b>
Configuration	AP Configure menu on page 133
Radio	<b>AP Radio page</b> on page 134
Quality of Service	<ul style="list-style-type: none"> <li><b>AP Quality of Service page</b> on page <b>145</b></li> </ul>
System	<b>AP System page</b> on page <b>147</b>
Network	<b>AP Network page</b> on page <b>153</b>
Security	AP Security page on page <b>158</b>
Monitor	<b>AP Monitor menu</b> on page 161
Performance	AP Performance page on page <b>162</b>
System	<b>AP System page</b> on page <b>168</b>
Wireless	<b>AP Wireless page</b> on page <b>170</b>
Throughput Chart	<b>AP Throughput Chart page</b> on page <b>173</b>
GPS	<b>AP GPS page</b> on page <b>173</b>
Network	<b>AP Network page</b> on page <b>176</b>
System Log	AP System Log page on page 179
Tools	AP Tools menu on page 180
Software Upgrade	AP Software Upgrade page on page 181
Backup / Restore	AP Backup/Restore page on page 183
License Management	AP License Management page on page 183
eDetect	AP eDetect page on page 183
Spectrum Analyzer	AP Spectrum Analyzer page on page 189
Automatic Channel Selection	AP Automatic Channel Selection page on page 192
eAlign	AP eAlign page on page 194
Wireless Link Test	AP Wireless Link Test page on page 196
Ping	<b>AP Ping page</b> on page <b>197</b>

## AP CONFIGURE MENU

Use the **Configure** menu to access all applicable device configuration parameters. The configuration menu contains the following pages:

- **AP Radio page** on page 134
- **AP Quality of Service page** on page 145
- **AP System page** on page 147
- AP Network page on page 153
- AP Security page on page 158

### AP Radio page

Use the Radio page to configure the device radio interface parameters.



Caution

Plan Configuration modifications since modifying radio parameters may result in a wireless outage.

Figure 41 AP Radio page

The screenshot displays the 'AP Radio' configuration page in the Cambiun Networks ePMP 2005 web interface. The page is organized into several sections:

- General:**
  - Radio Mode:  Access Point,  Subscriber Module,  Spectrum Analyzer
  - Driver Mode:  TDD,  Standard WiFi,  ePTP Master,  TDD PTF
  - Country:
  - Range Unit:  Miles,  Kilometers
- Access Point Configuration:**
  - SSID:
  - Max Registrations Allowed:  (min: 1, max: 120)
  - Max Range:  (min: 1, max: 40)
  - Automatic Channel Selection:  Disabled,  Enabled
  - Channel Bandwidth:  5 MHz,  10 MHz,  20 MHz,  40 MHz
  - Frequency Center:
  - Frequency Range:  Off,  Front Sector,  Back Sector
  - Alternate Frequency Carrier 1 Channel Bandwidth:  5 MHz,  10 MHz,  20 MHz,  40 MHz
  - Alternate Frequency Carrier 1:
  - Alternate Frequency Carrier 2 Channel Bandwidth:  5 MHz,  10 MHz,  20 MHz,  40 MHz
  - Alternate Frequency Carrier 2:
- Power Control:**
  - Transmitter Output Power:  dBm (min: 0, max: 30)
  - Antenna Gain:  dB (min: 0, max: 40)
  - Subscriber Module Target Receive Level:  dBm (min: -80, max: 40)
  - Uplink Antenna Selection:  Auto,  Forced Sector Antenna,  Forced Smart Antenna
- Scheduler:**
  - Downlink/Uplink Ratio:  75/25,  50/50,  30/70,  Flexible
  - Frame Size:  2.5 ms,  5 ms
  - Downlink Max Rate:
  - Management Traffic Rate:  MCS0,  MCS1
- Synchronization:**
  - Callocation Mode:  Disabled,  Enabled
  - Synchronization Source:  GPS,  CMME,  CNM4,  Internal
  - Synchronization Holdoff Time:  ms (min: 20, max: 86400)

© 2017 Cambium Networks, All Rights Reserved | Version 3.3.RC14 | Support | Community Forum

**Table 95** AP Radio Configuration attributes

Attribute	Meaning
General	
Radio Mode	This parameter controls the function of the device – All ePMP devices may be configured to operate as an Access Point (AP), Subscriber Module (SM) or as a Spectrum Analyzer. For initial link bring-up, choose <b>AP</b> .
Driver Mode	<p><b>TDD:</b> The Access Point is operating in point-to-multipoint (PMP) mode using TDD scheduling. The AP is able to GPS synchronize in this mode (except when in Flexible mode).</p> <p><b>Standard WiFi:</b> The Access Point is operating as a Standard 802.11n Access Point and will allow any 802.11 client to connect to it. QoS capability and Link Quality/Capacity indicators are not available in this mode.</p> <p><b>ePTP Master:</b> The Access Point is operating as a Master in point-to-point mode. The AP does not support GPS Synchronization in this mode but is able to provide <b>significantly lower latency</b> than other modes. QoS (MIR and traffic priority) capability and Link Quality/Capacity indicators are not available in this mode.</p> <p><b>TDD PTP:</b> The Access Point is operating in point-to-point (PTP) mode using TDD scheduling. The AP is able to GPS synchronize in this mode (except when in Flexible mode).</p>
Point-to-Point Access	<p><b>First Subscriber Module:</b> The system is configured to accept only the 1<sup>st</sup> registered SM. Network entry is denied for all subsequent SM network entry requests.</p> <p><b>MAC Filtering:</b> The system is configured to accept only one SM registration, and this registration is limited by SM MAC Address (the SM Wireless MAC Address).</p>
Subscriber Module Wireless MAC	Configure the Wireless MAC Address of the sole SM which is granted registration to the AP. All other network entry attempts are rejected by the AP. The SM's <b>Preferred AP List</b> may be configured with the destination point-to-point AP to ensure that the SM connects with the intended AP.
Country	<p>From the drop-down list, select the country in which the radio is operating.</p> <p>Country Code settings affect the radios in the following ways:</p> <ul style="list-style-type: none"> <li>• Maximum transmit power limiting (based on radio transmitter power plus configured antenna gain)</li> <li>• DFS operation is enabled based on the configured country code, if applicable</li> <li>• Frequency selection limiting, based on regional limitations</li> </ul>
Range Unit	<p><b>Miles:</b> The <b>Max Range</b> setting and resulting frame calculations are configured in units of miles.</p> <p><b>Kilometers:</b> The <b>Kilometers</b> setting and resulting frame calculations are configured in units of kilometers.</p>
Access Point Configuration	
SSID	The <b>AP SSID</b> is used to identify the AP and is used to configure the SM with the appropriate AP with which to register. Ensure that this parameter is configured uniquely for each AP in the network.

Attribute	Meaning
Max Registrations Allowed	<p>Based on sector/network planning and SM service level implementations, this parameter allows the user to set the maximum number of SMs that are allowed to register/network entry. The maximum number of SMs allowed for each channel bandwidth is as follows:</p> <p>20/40 MHz : 120 subscribers</p> <p>10 MHz : 60 subscribers</p> <p>5 MHz: 30 subscribers</p> <p>Default value is <b>60</b>.</p> <p>For DFS regions, the max number of SMs will be limited based on the channel bandwidth of the current operating channel, i.e. Frequency Carrier, Alternate Frequency Carrier 1 or Alternate Frequency Carrier 2.</p>
Max Range	<p>Enter a number of miles or kilometers for the furthest distance from which an SM is allowed to register to this AP. Do not set the distance to any greater number of miles. A greater distance:</p> <ul style="list-style-type: none"> <li>• does not increase the power of transmission from the AP.</li> <li>• can reduce aggregate throughput.</li> </ul> <p>Regardless of this distance, the SM must meet the minimum requirements for an acceptable link. The AP will reject any SM network entry attempts from outside the configured maximum range. Default value is <b>3 miles</b>.</p>
WLAN	<p>When the <b>Access Point Mode</b> is set to <b>Standard WiFi</b>, configure this parameter:</p> <p><b>Enabled:</b> The ePMP AP operates as WLAN device and allows any 802.11 client to connect to it within a 100 meter radius.</p> <p><b>Disabled:</b> The ePMP AP operates in Standard WiFi mode to allow outdoor 802.11n clients to connect to it at longer distances and is typically used to migrate non-Cambium SMs to ePMP SMs.</p>
Automatic Channel Selection	<p><b>Enabled</b> – This enables the Automatic Channel Selection (ACS) feature. ACS allows the radio to scan the entire band (governed by the <b>Country</b> setting) and chooses a channel with the lowest channel occupancy i.e. lowest interference level. To run the ACS feature (once enabled), the radio will have to be rebooted or manually triggered using Tools-&gt;Automatic Channel Selection. When ACS is running, the radio measures the occupancy level of the channel (measured in terms of an internal interference metric) and uses an algorithm to make a decision to choose the best channel within the band. The channel chosen is not based just on the occupancy level channel but also the occupancy level of adjacent channels.</p> <p><b>Disabled</b> – ACS is disabled and the operator should configure a <b>Frequency Carrier</b> manually.</p> <p> <b>Note</b></p> <p>The channel bandwidth configured prior to enabling and running ACS will be used to automatically select a channel. For ex: If the operator manually configured a channel bandwidth of 20MHz, ACS will scan and choose a channel of 20MHz wide channel. To switch ACS to 40MHz or other channel bandwidth, the operator should disable ACS, manually configure 40MHz or desired channel bandwidth on the radio, then enable and run ACS.</p>
Channel Bandwidth	<p>Configure the channel size used by the radio for RF transmission. This value must match between the AP and SMs.</p>



Attribute	Meaning
Frequency Carrier	Configure the frequency carrier for RF transmission. This list is dynamically adjusted to the regional restrictions based on the setting of the <b>Country Code</b> parameter.
Frequency Reuse	<p>The <b>Frequency Reuse Mode</b> parameter allows operators to define which APs are co-located (or within radio range) with other APs. This definition results in an automatic radio network modification such that self-interference is reduced amongst the co-located sectors.</p> <p>A network in which two frequencies “F1” and “F2” are reused throughout the installation is shown in <a href="#">Figure 39</a>.</p>

**Figure 42** Frequency reuse installation

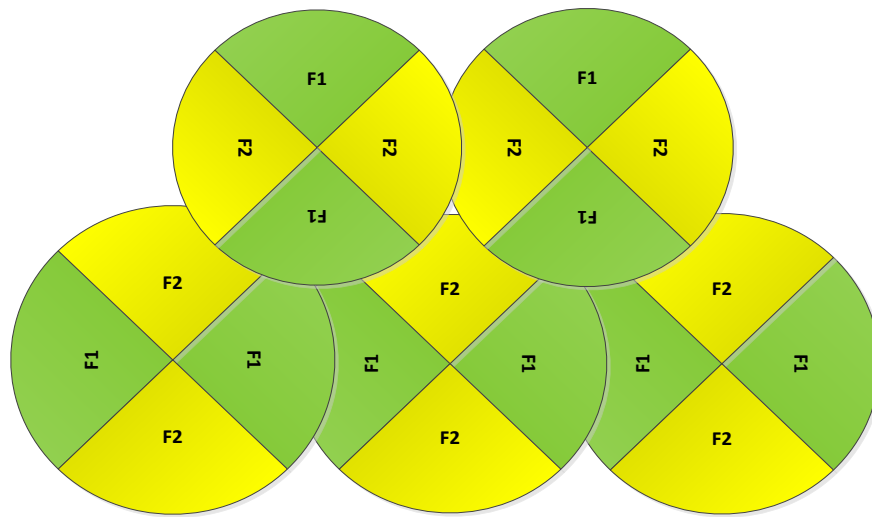

The set of APs to configure the **Frequency Reuse Mode** option on is dependent on the GPS synchronization sources in the whole network, CMM3, CMM4 or “onboard GPS” (GUI options are: **GPS** or **CMM**).

***The GPS sync source is the same on all APs or is a combination of “onboard GPS” and CMM4***

In this configuration the GPS synchronization source in the whole network is one of the following:

- 1- “onboard GPS” or
- 2- CMM4 or
- 3- CMM3 or
- 4- Mix of “onboard GPS” and CMM4 (but NOT CMM3)

For instructions on how to configure **Frequency Reuse Mode** to ensure that interference is reduced throughout the installation, see [Figure 40](#).

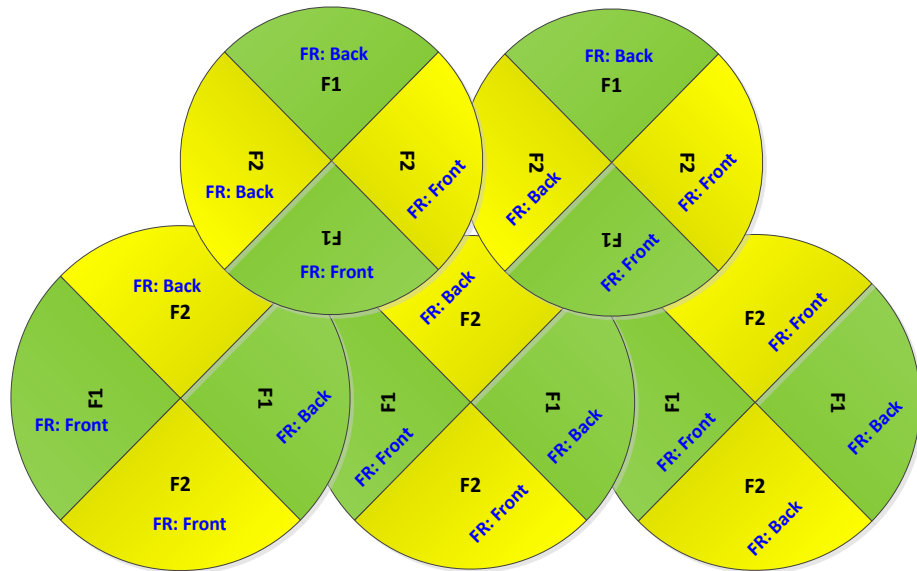
**Figure 43** Frequency reuse configuration example

The rules in selecting the APs to enabling the **Frequency Reuse Mode** in this installation are:

- 1- Only ONE of the APs on the same tower configured with the same frequency must be configured with the **Frequency Reuse Mode** parameter set to **Frequency-Reuse-Back**; the other AP must be configured with **Frequency Reuse Mode** set to **Frequency-Reuse-Front**.  
Also, APs on different towers facing each other with overlapped coverage must be configured with **Frequency Reuse Mode** set to **Frequency-Reuse-Back**.

***The GPS sync source is a mixture of all types (CMM3, CMM4 & “onboard GPS”)***

In this configuration the GPS sync source in the whole network is one of the following:

- 1- (CMM3 and “onboard GPS”) or
- 2- (CMM3 and CMM4) or
- 3- (CMM3 and CMM4 and “onboard GPS”)

For more examples of which APs to enable the **Frequency Reuse Mode** feature in this mixture of sync sources, see [Figure 41](#) and [Figure 42](#)

**Figure 44** Example 1 - Frequency reuse configuration, mixture of GPS synchronization sources

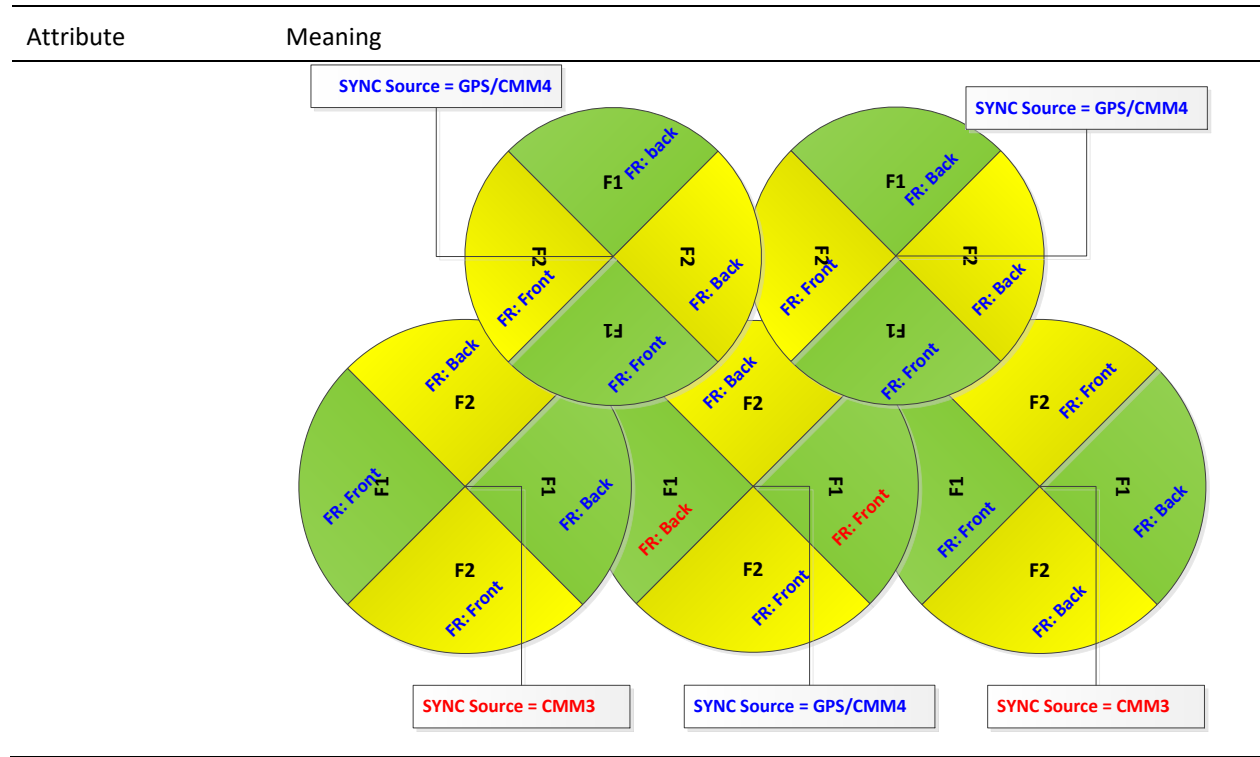

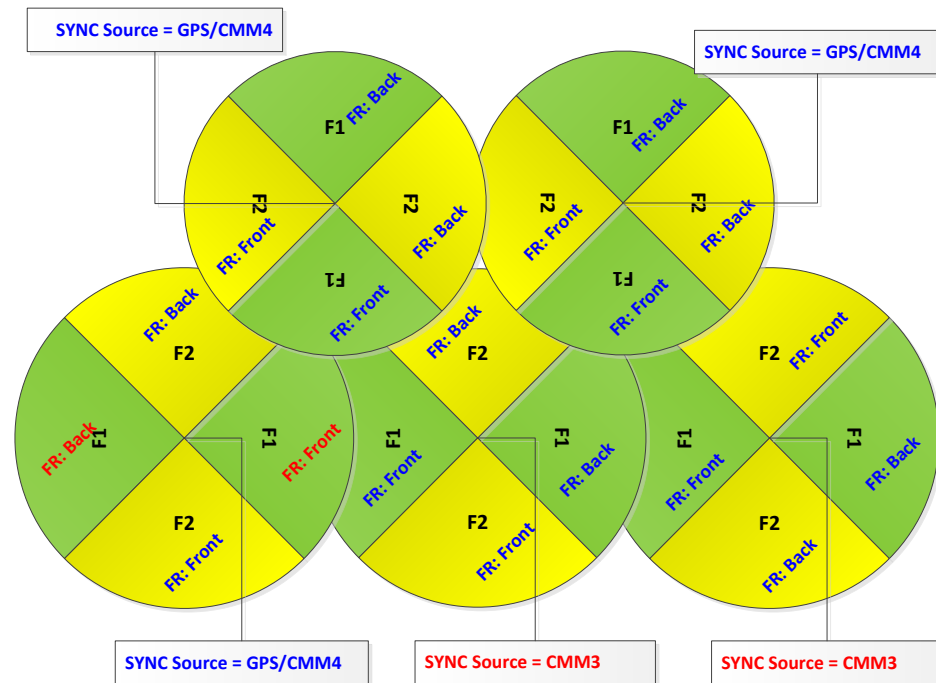

**Figure 45** Example 2 - Frequency Reuse Configuration with Mixture of GPS sources

The rules in selecting the APs to configure **Frequency Reuse Mode** to **Frequency Reuse Mode** to **Frequency-Reuse-Front** or **Frequency-Reuse-Back** in a mixture of sync sources installations are:

- 1- Only ONE of the APs on the same tower configured with the same frequency must have **Frequency Reuse Mode** set to **Frequency-Reuse-Back** if the sync source of both APs is the same or the sync is a combination of “onboard GPS” and CMM4; the other AP will have the **Frequency-Reuse-Front** ON.
- 2- For the APs on different towers facing each other with overlapped coverage:
  - a. If both APs have the same sync source then only ONE of them must have the **Frequency-Reuse-Back** ON; the other AP shall have the **Frequency-Reuse-Front** ON.
  - b. If one AP has “onboard GPS” as sync source and the other one has CMM4 then only ONE of them must have **Frequency-Reuse - Back** ON; the other AP shall have **Frequency-Reuse-Front** ON.
  - c. If one AP has “onboard GPS” or CMM4 as sync source and the other one has CMM3 then:
    - i. If the AP with CMM3 sync source has **Frequency-Reuse-Back** ON, then the other AP (with “onboard GPS” or CMM4 sync source) must have the **Frequency-Reuse-Back** ON.

Attribute	Meaning
	<p>ii. If the AP with CMM3 sync source has <b>Frequency Reuse Mode</b> set to <b>Off</b>, then the other AP (with “onboard GPS” or CMM4 sync source) must have <b>Frequency Reuse Mode</b> set to <b>Off</b>.</p>
Alternate Frequency Carrier 1 Channel Bandwidth	Configure the first channel bandwidth configuration that will be used for RF transmission if DFS detection causes the radio to switch from using the channel bandwidth configured in <b>Channel Bandwidth</b> .
Alternate Frequency Carrier 1	Configure the first frequency that will be used for RF transmission if DFS detection causes the radio to switch from using the frequency configured in <b>Frequency Carrier</b> . It is important to set this frequency also in the <b>SM Scan List</b> .
Alternate Frequency Carrier 2 Channel Bandwidth	Configure the second channel bandwidth configuration that will be used for RF transmission if DFS detection causes the radio to switch from using the channel bandwidth configured in <b>Channel Bandwidth</b> .
Alternate Frequency Carrier 2	Configure the second frequency that is used for RF transmission if DFS detection causes the radio to switch from using the frequencies configured in <b>Frequency Carrier</b> and <b>DFS Alternate Frequency Carrier 1</b> . It is important to set this frequency also in the <b>SM Scan List</b> .
<b>Power Control</b>	
Transmitter Output Power	<p>This value represents the combined power of the AP’s two transmitters. This value may be automatically adjusted based on the configuration of the parameter <b>Country</b>.</p> <p>Nations and regions may regulate transmitter output power. For example</p> <ul style="list-style-type: none"> <li>• 2.4 GHz and 5 GHz modules are available as connectorized radios, which require the operator to adjust power to ensure regulatory compliance.</li> </ul> <p>The professional installer of the equipment has the responsibility to</p> <ul style="list-style-type: none"> <li>• maintain awareness of applicable regulations.</li> <li>• calculate the permissible transmitter output power for the module.</li> <li>• confirm that the initial power setting is compliant with national or regional regulations</li> <li>• confirm that the power setting is compliant following any reset of the module to factory defaults.</li> </ul>
Antenna Gain	This value represents the amount of gain introduced by an external antenna (minus cable loss). This value is used in calculating the unit’s Equivalent Isotropic Radiated Power (EIRP) level. For certain <b>Country Code</b> configurations, the unit’s EIRP may be limited based on regional regulations.

Attribute	Meaning
Subscriber Module Target Receive Level	<p>Each SM's transmitter output power is automatically set by the AP. The AP monitors the received power from each SM and adjusts each SM's transmitter output power so that the received power at the AP from the SM is not greater than what is configured in <b>SM Target Received Power Level</b>. These automatic power adjustments ensure that the SM is not transmitting excessive energy (raising system noise level) and that the SM is able to achieve an optimal modulation state (and maximum achievable throughput).</p> <p>Nominally, target receive levels must be set lesser than -60 dBm in order to prevent interference from co-located co-channel sectors.</p>
Uplink Antenna Selection	<p><b>Uplink Antenna Selection</b> specifies the antenna to be used in the uplink. This parameter is specific to ePMP 2000 APs with optional Smart Antenna.</p> <p><b>Auto:</b> The AP decides which antenna to use (sector or Smart Antenna) for uplink communications based on internal quality metrics.</p> <p><b>Forced Sector Antenna:</b> The AP uses the Sector Antenna for all SM uplink communications.</p> <p><b>Forced Smart Antenna:</b> The AP uses the smart antenna for all SM uplink communications.</p>
<div style="background-color: #f0f0f0; padding: 10px;">  <b>Note</b>  <p>If the AP is configured with <b>Uplink Antenna Selection</b> set to <b>Auto</b> and an SM is set to <b>Forced Sector Antenna</b> or <b>Forced Smart Antenna</b>, the SM setting will be enforced.</p> <p>If the AP is configured with <b>Uplink Antenna Selection</b> set to <b>Forced Sector Antenna</b> or <b>Forced Smart Antenna</b> and a SM is set to a conflicting <b>Forced</b> setting, the AP's setting will be enforced.</p> </div>	
Scheduler	
Downlink/Uplink Ratio	<p>Configure the schedule of downlink traffic to uplink traffic on the radio link. The first three options, <b>75/25</b>, <b>50/50</b> and <b>30/70</b>, allow the radio to operate in a fixed ratio on every frame. In other words, this ratio represents the amount of the total radio link's aggregate throughput that will be used for downlink resources, and the amount of the total radio link's aggregate throughput that will be used for uplink resources. The fourth option, <b>Flexible</b>, allows the radio to dynamically choose the amount of the total radio's aggregate throughput that is used for downlink and uplink resources, every frame.</p>
<div style="background-color: #f0f0f0; padding: 10px;">  <b>Caution</b>  <p>Setting this parameter to Flexible causes the radio to operate in unsynchronized mode. For all other settings, if the AP is in a cluster or is in range of another AP, then you must set this parameter on all other APs in the cluster and in range exactly the same. Otherwise, overlapping RF transmissions will introduce system interference.</p> </div>	

Attribute	Meaning
Frame Size	Configure the frame size for use when in <b>TDD</b> or <b>TDD PTP</b> mode. <b>2.5 ms</b> frame size allows for co-location (Synchronization) with PMP 100 series of radios. It provides lower latency than <b>5 ms</b> frame with approximately 10% lower throughput. Frame size is irrelevant when the <b>Downlink/Uplink Ratio</b> is set to <b>Flexible</b> . Please refer to the “ <a href="#">ePMP and PMP 100 Co-location and Migration Recommendations Guide</a> ” for guidance on synchronizing ePMP and PMP 100.
Downlink Max Rate	Configure the MCS (Modulation and Coding Scheme) rate beyond which the radio’s scheduler should not exceed when transmitting data traffic on the downlink. This is useful in situations where there is high variance and unpredictability in the interference present in the environment causing packet loss. Reducing the max rate to a lower MCS (than the default MCS 15) may help in these situations. Reducing the Downlink Max Rate will result in reduced sector capacity. Not available when AP is an <b>ePTP Master</b> or <b>Standard WiFi</b> .
Management Traffic Rate	<p><b>MCS0:</b> The system is configured to use MCS0 rate for all management messages. This allows for improved link stability and range in high interference environment.</p> <p><b>MCS1:</b> The system is configured to use MCS1 rate for all management messages. This allows for slightly higher sector throughput. This is the default setting.</p>
Synchronization	
Co-location Mode	<p><b>Disabled:</b> The ePMP device is able to synchronize only with other ePMP Access Points.</p> <p><b>Enabled:</b> The ePMP device can be configured to synchronize with PMP 100 or PMP 450 series of radios in addition to other ePMP Access Points. Please refer to the “<a href="#">ePMP and PMP 100 Co-location and Migration Recommendations Guide</a>” for guidance on synchronizing ePMP and PMP 100. Verify that frame size (ms) is configured equally across the co-located installations.</p>
Synchronization Source	<p><b>GPS:</b> Synchronization timing is received via the AP’s connected GPS antenna. Co-located or in-range APs receiving synchronization via GPS or CMM transmits and receives at the same time, thereby reducing self-interference.</p> <p><b>CMM3 and CMM4:</b> Synchronization timing is received via the AP’s Ethernet port via a connected Cambium Cluster Management Module (CMM). Co-located or in-range APs receiving synchronization via GPS or CMM will transmit and receive at the same time, thereby reducing self-interference. For more information on CMM configuration, refer to the <i>PMP Synchronization Solutions User Guide</i>.</p> <p><b>Internal:</b> Synchronization timing is generated by the AP and the timing is not based on GPS pulses.</p> <p> Caution</p> <p>If a CMM is being used, verify that the cables from the CMM to the network switch are at most 30 ft (shielded) or 10 Ft (unshielded) and that the network switch is not PoE (802.3af).</p> <p>APs using Synchronization Source of <b>Internal</b> will not transmit and receive in sync with other co-located or in-range APs, which introduces self-interference into the system.</p>
Synchronization Source of Co-located System	Configure the Synchronization source of the co-located <b>PMP 100</b> Access Point.

Attribute	Meaning
	<p><b>GPS:</b> The co-located PMP 100 AP receives synchronization timing via the Cambium <b>UGPS (Universal Global Positioning System)</b> module. Co-located or in-range ePMP APs receiving synchronization via GPS or CMM transmits and receives at the same time, thereby reducing self-interference.</p> <p><b>CMM3 and CMM4:</b> The co-located PMP 100 AP receives synchronization timing its Ethernet port via a connected Cambium Cluster Management Module (CMM). Co-located or in-range ePMP APs receiving synchronization via GPS or CMM will transmit and receive at the same time, thereby reducing self-interference. For more information on CMM configuration, refer to the <i>PMP Synchronization Solutions User Guide</i>. Please refer to the <a href="#">ePMP and PMP 100 Co-location and Migration Recommendations Guide</a> for guidance on synchronizing ePMP and PMP 100.</p>
Synchronization Holdoff Time	<p>The <b>Synchronization Holdoff Time</b> is designed to gracefully handle fluctuations/losses in the GPS synchronization signaling. After the AP has received a reliable synchronization pulse for at least 60 seconds, if there is a loss of synchronization signal, the <b>Synchronization Holdoff</b> timer is started. During the holdoff interval, all SM registrations are maintained. If a valid GPS synchronization pulse is regained during the holdoff interval, then the AP continues to operate normally. If a valid synchronization pulse is not regained from the GPS source during the holdoff interval, then the AP ceases radio transmission. Default is <b>30 seconds</b>.</p>
Advanced	<p>RTS/CTS (Request to Send / Clear to Send) is the optional mechanism used by the 802.11 (Standard WiFi) wireless networking protocol to reduce frame collisions introduced by the problem known as hidden node problem. Under this mechanism, specific RTS, CTS and ACK (Acknowledgement) frames are exchanged between the AP and SM to schedule transmission of packets over the wireless link. The ability to use this mechanism is available when <b>Access Point Mode</b> is configured as <b>Standard WiFi</b>.</p>
Downlink CTS	<p>This parameter applies to CTS mechanism for downlink data transmission.</p> <p><b>Disabled:</b> The AP does not wait for a CTS frame from the SM/Client before it sends downlink data.</p> <p><b>Enabled:</b> The AP simulates a CTS frame sent to itself notifying the SMs connected to it that it is going to transmits data on the downlink.</p>
Uplink CTS/RTS	<p>This parameter applies to RTS/CTS mechanism for uplink data transmission. When <b>Enabled</b>, SM/Client must send an RTS frame and, only upon receiving a CTS frame from the AP can it transmit uplink data.</p>
RTS Threshold	<p>Configure the RTS packet size threshold for downlink data transmission. Range is between 0–2347 octets. Typically, sending RTS/CTS frames does not occur unless the packet size exceeds this threshold. If the packet size that the node wants to transmit is larger than the threshold, the RTS/CTS handshake gets triggered. Otherwise, the data frame gets sent immediately.</p>



### AP Quality of Service page

The ePMP platform supports three QoS priority levels (not available in ePTP Master mode) using air fairness, priority-based starvation avoidance scheduling algorithm.

Ordering of traffic amongst the priority levels is based on a percentage of total link throughput. In other words, all priorities receive some throughput so that low priority traffic is not starved from transmission. In effect, the greatest amount of throughput is guaranteed to the VOIP priority level, then High, then Low.

Priority Level	ePMP Traffic Priority Label
Highest Priority	VOIP (only utilized when <b>VOIP Enable</b> is set to <b>Enabled</b> )
Medium Priority	High
Lowest Priority	Low

By default, all traffic passed over the air interface is low priority. The AP's Quality of Service page may be utilized to map traffic to certain priority levels using QoS classification rules. The rules included in the table are enforced starting with the first row of the table.



Caution

Each additional traffic classification rule increases device CPU utilization. Careful network traffic planning is required to efficiently use the device processor.

The ePMP platform also supports radio data rate limiting (Maximum Information Rate, or MIR) based on the configuration of the MIR table. Operators may add up to 16 MIR profiles on the AP, each with unique limits for uplink and downlink data rates. The SM field **MIR Profile Setting** is used to configure the appropriate MIR profile for limiting the SM's data rate.

Figure 46 AP Quality of Service page

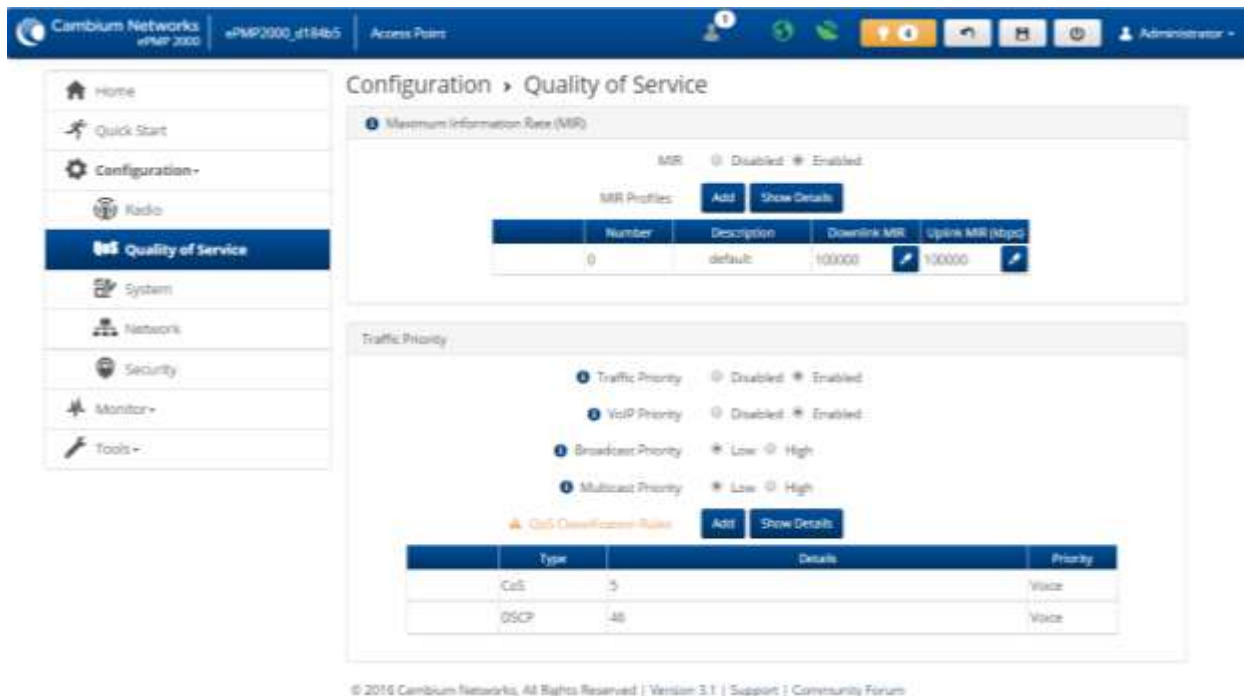

**Table 96** AP Radio Configuration attributes

Attribute	Meaning
Maximum Information Rate (MIR)	
MIR	<p><b>Disabled:</b> When disabled, RF transmission is only limited by the capacity of the link (and any active QoS classification rules).</p> <p><b>Enabled:</b> When enabled, all downlink and uplink traffic is limited based on the profiles configured in the MIR table.</p>
MIR Profiles	The MIR (Maximum Information Rate) table is comprised of up to sixteen profiles which, after configured, may be set on the SM to employ a certain service level or data rate.
Number	Assign a profile number to each row in the AP MIR table. This profile number is then set on each SM to limit data transfer rates based on the operator's configuration of the MIR table and its profiles.
Description	Assign a logical description for each service level. For example, a tiered service-level provider may deploy service levels "Gold", "Silver" and "Bronze" or "20 Mbps", "10 Mbps" and "5 Mbps" to offer a clear description.
Downlink MIR (kbps)	Specify the downlink rate at which the AP is allowed to transmit for this configured profile.
Uplink MIR (kbps)	Specify the uplink rate at which the AP is allowed to transmit for this configured profile.
Traffic Priority	
Traffic Priority	<p><b>Disabled:</b> No traffic prioritization is performed. All traffic is treated with equal priority (low priority).</p> <p><b>Enabled:</b> Traffic prioritization is enabled and specific types of traffic can be prioritized using the fields below.</p>
VoIP Priority	<p><b>Enabled:</b> When enabled, two entries are automatically added to the first and second rows of the QoS Classification Rules table, one with <b>Rule Type CoS</b> (5) and one with <b>Rule Type DSCP</b> (46). The addition of these rules ensures that VoIP traffic passed over the radio downlink is given highest priority. The <b>CoS</b> and <b>DSCP</b> values may be modified to accommodate non-standard VoIP equipment.</p> <p><b>Disabled:</b> When disabled, VoIP traffic is scheduled normally along with all other user data.</p>
Broadcast Priority	<p><b>Low Priority:</b> All Broadcast traffic sent over the downlink is prioritized as low priority and is delivered to the SM after scheduled high priority and VoIP traffic.</p> <p><b>High Priority:</b> All Broadcast traffic sent over the downlink is prioritized as high priority and is scheduled for delivery to SMs before low priority traffic but after VoIP traffic.</p>
Multicast Priority	<p><b>Low Priority:</b> All Multicast traffic sent over the downlink is prioritized as low priority, and will be delivered to the SM after scheduled high priority and VoIP traffic.</p> <p><b>High Priority:</b> All Multicast traffic sent over the downlink is prioritized as high priority and is scheduled for delivery to SMs before low priority traffic but after VoIP traffic.</p>

Attribute	Meaning
QoS Classification Rules	The QoS Classification Rules table contains all of the rules enforced by the device when passing traffic over the radio downlink. Traffic passed through the device is matched against each rule in the table; when a match is made the traffic is sent over the radio link using the priority defined in column <b>Traffic Priority</b> .
Type	<p><b>CoS:</b> Class of Service; traffic prioritization is based on the 3-bit header present in the 802.1Q VLAN-tagged Ethernet frame header in the packet entering the AP's Ethernet port.</p> <p><b>VLAN ID:</b> traffic prioritization is based on the VLAN ID of the packet entering the AP's Ethernet port.</p> <p><b>EtherType:</b> traffic prioritization is based on the two-octet Ethertype field in the Ethernet frame entering the AP's Ethernet port. The Ethertype is used to identify the protocol of the data in the payload of the Ethernet frame.</p> <p><b>IP:</b> traffic prioritization is based on the source and (or) destination IP address of the packet entering the AP's Ethernet port. A subnet mask may be included to define a range of IP addresses to match.</p> <p><b>MAC:</b> traffic prioritization is based on the source and (or) destination MAC address of the packet entering the AP's Ethernet port. A mask may be included to define a range of MAC addresses to match. The mask is made up of a hex representation of a series of 1s to start the mask and 0s that end the mask. A 1 may not follow a 0. Thus FF:FF:FF:FF:00:00 is allowed, but FF:00:FF:FF:FF:FF is not. The MAC address is combined with the mask to define the range of allowed MAC addresses.</p>
Details	Represents the details of the Class of Service (CoS) present in the packet entering the AP's Ethernet port.
Priority	Represents the QOS classification rule priority.

### ***AP System page***

The AP's System page is used to configure system parameters, services, time settings, SNMP and syslog.

Figure 47 AP System page

The screenshot displays the 'Configuration > System' page for a Cambium Networks ePMP 2000 device. The interface includes a top navigation bar with the device name 'ePMP2000\_d184b5' and the role 'Access Point'. A left sidebar contains navigation options: Home, Quick Start, Configuration, Radio, Quality of Service, System (selected), Network, Security, Monitor, and Tools.

The main configuration area is divided into several sections:



- General:** Device Name (ePMP2000\_d184b5), Webpage Auto Update (5 sec), Web Access (HTTP, HTTPS), HTTP Port (80), SSH Access (Disabled, Enabled), Telnet Access (Disabled, Enabled), MAC-Telnet Access (Disabled, Enabled), and MAC-Telnet Protocol (MAC-Telnet, MAC-SSH).
- Network Time Protocol (NTP):** IP Assignment (Static, DHCP), Preferred NTP Server, Alternate NTP Server, and Time Zone (UTC GMT - Greenwich Mean Time).
- Location Services:** On-board GPS Latitude (42.05337 degrees), On-board GPS Longitude (-088.02551 degrees), On-board GPS Height (241.3 meters), Use GPS Coordinates (Update), Device Latitude (12.90 degrees), Device Longitude (77.88 degrees), Device Height (meters), and Device Location (Open in Google Maps).
- Simple Network Management Protocol (SNMP):** Read-Only Community String (kreddum-123\_234), Read-Write Community String (kreddum-123\_234), System Name (kreddum), System Description (kreddum), Traps (Disabled, Enabled), Trap Community String (kreddumtrap), and Trap Servers (Add, Show Details).
- System Logging (Syslog):** Server 1-4, SysLog Mask (Unselect All, Select All), and checkboxes for Info, Notices, Warnings, Errors, Alerts, and Emergency.
- cnMaestro:** Remote Management (Disabled, Enabled), cnMaestro URL (https://qa.cloud.cambiumnetworks.com), Cambium ID, and Onboarding Key.
- Account Management:** Administrator Account (Disabled, Enabled) with Username (admin) and Password; Home User Account (Disabled, Enabled) with Username (home) and Password; Installer Account (Disabled, Enabled) with Username (installer) and Password; and Read-Only Account (Disabled, Enabled) with Username (readonly) and Password.



© 2016 Cambium Networks, All Rights Reserved | Version 3.1 | Support | Community Forum

Table 97 AP System attributes

Attribute	Meaning
General	
Device Name	Specifies the name of the AP.
Webpage Auto Update	Configure the interval for which the device retrieves system statistics for display on the management interface. For example, if this setting is configured to 5 seconds, the statistics and status parameters displayed on the management interface will be refreshed every 5 seconds (default). <b>Webpage Auto Update is a session only configuration change. It is updated with the &lt;Enter&gt; key and is not savable when using the save button.</b>
Web Access	<b>HTTP:</b> Access to the device management GUI is conducted via HTTP. <b>HTTPS:</b> Access to the device management GUI is conducted via HTTPS.
HTTP Port	If <b>Web Service</b> is set to <b>HTTP</b> , configure the port which the device uses to service incoming HTTP requests for management GUI access.
HTTPS Port	If <b>Web Service</b> is set to <b>HTTPS</b> , configure the port which the device uses to service incoming HTTPS requests for management GUI access.
SSH Access	<b>Disabled:</b> If the SSH port to the device is 'Disabled', access to the device through SSH is not possible. <b>Enabled:</b> If the SSH port to the device is 'Enabled', Cambium engineers can access the device through SSH which enables them to login to the radio and troubleshoot. SSH port is 'Enabled' by default.
Telnet Access	<b>Disabled:</b> CLI access via telnet is not allowed for the device. <b>Enabled:</b> CLI access via telnet is allowed for the device.
MAC-Telnet Access	<b>Disabled:</b> Disables connections to the radio on the link layer via MAC address from RouterOS or mactelnet-enabled devices. <b>Enabled:</b> Enables connections to the radio on the link layer via MAC address from RouterOS or mactelnet-enabled devices.
	 <b>Note</b> In order to use MAC-Telnet the first time, the Administrator account password must be changed on the GUI or the CLI. This password can then be used for MAC-Telnet.
MAC-Telnet Protocol	<b>MAC-Telnet:</b> Use the MAC-Telnet subservice for access <b>MAC-SSH:</b> Use the secured MAC-SSH subservice for access
Network Time Protocol	
IP Assignment	<b>Static:</b> The device retrieves NTP time data from the servers configured in fields <b>NTP Server IP Address</b> . <b>DHCP:</b> The device retrieves NTP time data from the server IP issued via a network DHCP server.
Preferred NTP Server	Configure the primary NTP server IP addresses from which the device will retrieve time and date information.

Attribute	Meaning
Alternate NTP Server	Configure an alternate or secondary NTP server IP addresses from which the device retrieves time and date information.
Time Zone	The <b>Time Zone</b> option may be used to offset the received NTP time to match the operator's local time zone.
Location Services	
On-board GPS Latitude	On a GPS Synchronized ePMP radio, the field is automatically populated with the Latitude information from the on-board GPS chip.
On-board GPS Longitude	On a GPS Synchronized ePMP radio, the field is automatically populated with the Longitude information from the on-board GPS chip.
On-board GPS Height	On a GPS Synchronized ePMP radio, the field is automatically populated with the Height above sea level information from the on-board GPS chip.
Use GPS Coordinates	On a GPS Synchronized ePMP radio, the Device coordinates can be populated using the information retrieved from the on-board GPS chip. Click the  button to automatically populate the <b>Device Latitude</b> and <b>Device Longitude</b> fields using the coordinates provided by the on-board GPS chip.
Device Latitude	Configure Latitude information for the device in decimal format.
Device Longitude	Configure Longitude information for the device in decimal format.
Device Height	Configure height above sea level for the device in meters.
Device Location	Hyperlink to display the device location in Google Maps
Simple Network Management Protocol (SNMP)	
Read-Only Community String	Specify a control string that can allow a Network Management Station (NMS) such as the Cambium Networks Services Server (CNSS) to read SNMP information. No spaces are allowed in this string. This password will never authenticate an SNMP user or an NMS to read/write access.  The <b>Read-only Community String</b> value is clear text and is readable by a packet monitor.
Read-Write Community String	Specify a control string that can allow a Network Management Station (NMS) to access SNMP information. No spaces are allowed in this string.
System Name	Specify a string to associate with the physical module. This parameter can be polled by the Cambium Networks Services Server (CNSS) or an NMS. Special characters are supported.
System Description	Specify a description string to associate with the physical module. This parameter can be polled by the Cambium Networks Services Server (CNSS) or an NMS. Special characters are supported.
Traps	<b>Disabled:</b> SNMP traps for system events are not sent from the device.  <b>Enabled:</b> SNMP traps for system events are sent to the servers configured in table <b>Trap Servers</b> .

Attribute	Meaning
Trap Community String	Configure a SNMP Trap Community String which is processed by the servers configured in <b>Trap Servers</b> . This string is used by the trap server to decide whether or not to process the traps incoming from the device (i.e. for traps to successfully be received by the trap server, the community string must match).
Trap Servers	The <b>Trap Servers</b> table is used to configure trap destinations for SNMP traps generated by the device.
Server IP	Configure the IP address of each SNMP trap server target.
Server Port	Configure the port to which SNMP traps are sent from the ePMP device.
System Logging (Syslog)	
Server 1-4	Specify up to four syslog servers to which the device sends syslog messages.
SysLog Mask	Configure the levels of syslog messages which the devices send to the servers configured in parameters <b>Server IP 1-4</b> .  Caution Choose only the syslog levels appropriate for your installation. Excessive logging can cause the device log file to fill and begin overwriting previous entries.
cnMaestro	
Remote Management	When <b>Enabled</b> , the device will be managed by cnMaestro - the Cambium Remote Management System, which allows all Cambium devices to be managed in the cloud.
cnMaestro URL	Configure the URL of cnMaestro. The default value is <a href="https://cloud.cambiumnetworks.com">https://cloud.cambiumnetworks.com</a> .
Cambium-ID	Configure the Cambium ID that the device will use for on-boarding on to cnMaestro.
Onboarding key	Configure the password/key associated with the <b>Cambium-ID</b> that the device will use for on-boarding on to cnMaestro.
Account Management	
(Administrator) Username	Read-only listing of available login levels. <ul style="list-style-type: none"> <li>ADMINISTRATOR, full read write permissions.</li> <li>INSTALLER, permissions to read and write parameters applicable to unit installation and monitoring.</li> <li>HOME, permissions only to access pertinent information for support purposes.</li> <li>READONLY has permission to only view the Monitor page.</li> </ul>
(Administrator) Password	Configure a custom password for Administrator account. The password character display may be toggled using the visibility icon  .
Installer Account	<b>Disabled:</b> The disabled user is not granted access to the device management interface. The administrator user level cannot be disabled. <b>Enabled:</b> The user is granted access to the device management interface.
(Installer) Username	Provide the 'Installer Username' in this box.

Attribute	Meaning
(Installer) Password	Configure a custom password to secure the device. Only 'Administrator' account can override this password. The password character display may be toggled using the visibility icon  .
Home User Account	<b>Disabled:</b> The disabled user is not granted access to the device management interface. <b>Enabled:</b> The user is granted access to the device management interface
(Home) User Username	Provide the Home User 'Username' in this box.
(Home) User Password	Configure a custom password to secure the device in order access pertinent information for support purpose only. The password character display may be toggled using the visibility icon  .
Read-Only Account	<b>Disabled:</b> The disabled user is not granted access to the device management interface, even on a 'Read-Only' access. <b>Enabled:</b> The user is granted 'Read-Only' access to the device management interface.
(Read-Only) Username	Provide the Read-Only 'Username' in this box.
(Read-Only) Password	Provide the password that can be used for 'Read-Only' access. Password character display may be toggled using the visibility icon  .



### AP Network page

The AP's Network page is used to configure system networking parameters and VLAN parameters.

Figure 48 AP Network page

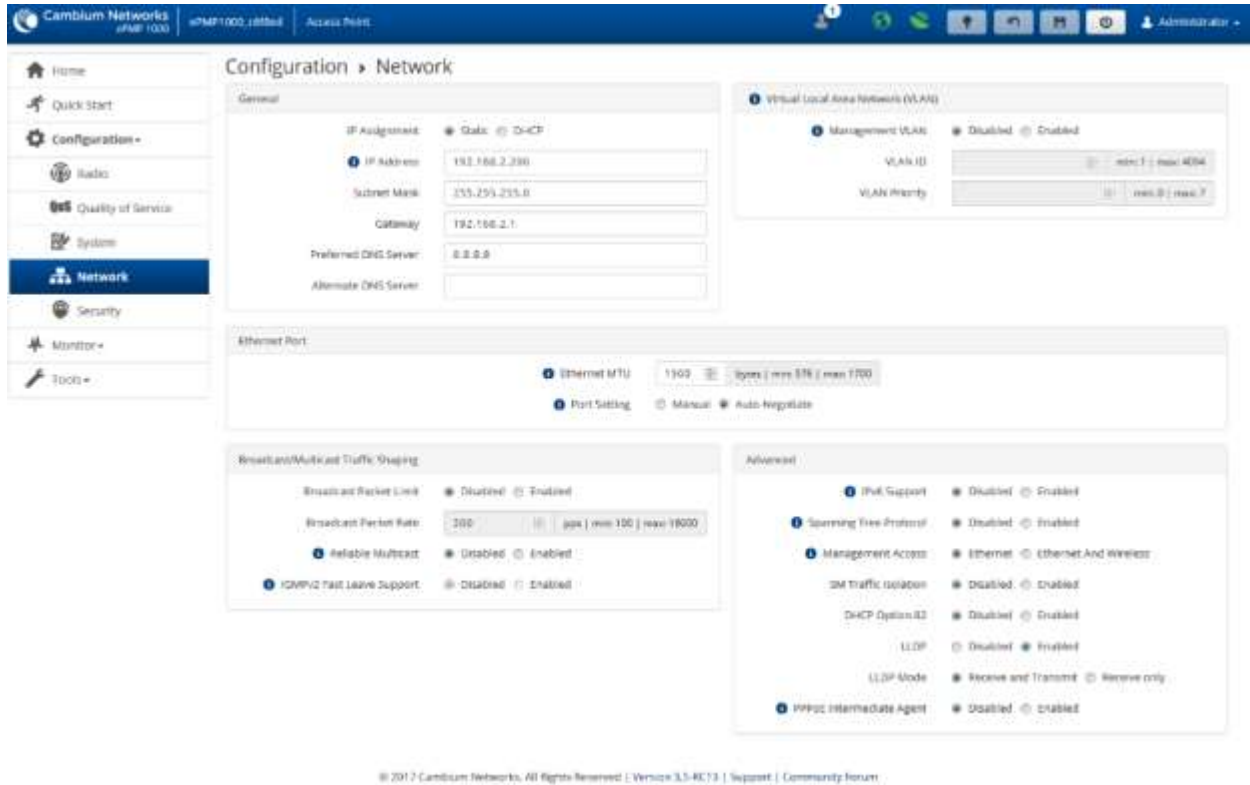





Table 98 AP Network attributes

Attribute	Meaning
General	
<b>IP Assignment</b>	<p>Static: <b>Device management IP addressing is configured manually in fields</b> Device IP Address (LAN), IP Subnet Mask (LAN), Gateway IP Address (LAN) <b>and</b> DNS Server IP Address (LAN).</p> <p>DHCP: <b>Device management IP addressing (IP address, subnet mask, gateway, and DNS server) is assigned via a network DHCP server, and parameters</b> Device IP Address (LAN), IP Subnet Mask (LAN), Gateway IP Address (LAN), <b>and</b> DNS Server IP Address (LAN) <b>are unused.</b></p>
<b>IP Address</b>	<p><b>Internet protocol (IP) address. This address is used by the family of Internet protocols to uniquely identify this unit on a network.</b></p> <div style="border: 1px solid gray; padding: 5px; margin-top: 10px;"> <p> <b>Note</b></p> <p>If Device IP address Mode is set to DHCP and the device is unable to retrieve IP address information via DHCP, the device management IP is set to fallback IP 192.168.0.1 (AP mode), 192.168.0.2 (SM mode), 192.168.0.3 (Spectrum Analyzer mode) or the previously-configured static Device IP Address. Units may always be accessed via the Ethernet port with IP 169.254.1.1.</p> </div>

Attribute	Meaning
<b>Subnet Mask</b>	<b>Defines the address range of the connected IP network. For example, if Device IP Address (LAN) is configured to 192.168.2.1 and IP Subnet Mask (LAN) is configured to 255.255.255.0, the device will belong to subnet 192.168.2.X.</b>
<b>Gateway</b>	<b>Configure the IP address of the device on the current network that acts as a gateway. A gateway acts as an entrance and exit to packets from and to other networks.</b>
<b>Preferred DNS Server</b>	<b>Configure the primary IP address of the server used for DNS resolution.</b>
<b>Alternate DNS Server</b>	<b>Configure the secondary IP address of the server used for DNS resolution.</b>
<b>IPv6 Assignment</b>	<p>IPv6 Assignment <b>specifies how the IPv6 address is obtained.</b></p> <p>Static: <b>Device management IP addressing is configured manually in fields IPv6 Address and IPv6 Gateway.</b></p> <p>DHCPv6: <b>Device management IP addressing (IP address and gateway) is assigned via a network DHCP server, and parameters IPv6 Address and IPv6 Gateway are unused. If the DHCPv6 server is not available previous static IPv6 address will be used as a fallback IPv6 address. If no previous static IPv6 address is available, no IPv6 address will be assigned. DHCPv6 will occur over the wireless interface by default.</b></p>
<b>IPv6 Address</b>	<p><b>Internet protocol version 6 (IPv6) address. This address is used by the family of Internet protocols to uniquely identify this unit on a network.</b></p> <p><b>IPv6 addresses are represented by eight groups of four hexadecimal digits separated by colons.</b></p>
<b>IPv6 Gateway</b>	<b>Configure the IPv6 address of the device on the current network that acts as a gateway. A gateway acts as an entrance and exit to packets from and to other networks.</b>
Virtual Local Area Network (VLAN)	
<b>Management VLAN</b>	<p><b>Enabled: The AP management interface can be assigned to a Management VLAN to separate management traffic (remote module management via SNMP or HTTP) from user traffic (such as internet browsing, voice, or video. Once the management interface is enabled for a VLAN, an AP's management interface can be accessed only by packets tagged with a VLAN ID matching the management VLAN ID.</b></p> <p>A VLAN configuration establishes a logical group within the network. Each computer in the VLAN, regardless of initial or eventual physical location, has access to the same data based on the VLAN architecture. For the network operator, this provides flexibility in network segmentation, simpler management and enhanced security.</p> <p><b>Disabled: When disabled, all IP management traffic is allowed to the device.</b></p>
<b>VLAN ID</b>	<b>Configure this parameter to include the device's management traffic on a separate VLAN network. For example, if MGMT VLAN ID is set to 2, GUI access will only be allowed from IP packets tagged with VLAN ID 2.</b>

Attribute	Meaning
<b>VLAN Priority</b>	<p>ePMP radios can prioritize VLAN traffic based on the eight priorities described in the IEEE 802.1p specification. <b>MGMT VLAN Priority</b> represents the VLAN Priority or Class of Service (CoS). Operators may use this prioritization field to give precedence to device management traffic.</p> <p>This parameter only takes effect if the MGMT VLAN parameter is enabled. Configure this parameter to set the value of the Priority code point field in the 802.1q tag for traffic on the management VLAN originating from the SM. The default value is 0.</p>
<b>Ethernet MTU</b>	<p><b>Maximum Transmission Unit; the size in bytes of the largest data unit that the device is configured to process. Larger MTU configurations can enable the network to operate with greater efficiency, but in the case of retransmissions due to packet errors, efficiency is reduced since large packets must be resent in the event of an error. Packets received by the device larger than the configured MTU are dropped.</b></p>
<b>Port Setting</b>	<p>Manual: <b>The LAN Ethernet port speed and duplex mode can be manually configured.</b></p> <p>Auto-Negotiate: <b>The AP auto negotiates the LAN Ethernet port speed and duplex mode with the device connected to it.</b></p>
<b>Port Speed</b>	<p><b>With “Ethernet Port Configuration” the LAN Ethernet port speed can be forced to 1000 Mbps, 100 Mbps or 10 Mbps.</b></p>
<b>Port Duplex Mode</b>	<p><b>With “Ethernet Port Configuration” the LAN Ethernet port duplex mode can be forced into Full or Half.</b></p>
Broadcast/Multicast Traffic Shaping	
<b>Broadcast Packet Limit</b>	<p><b>Enabled:</b> This allows the user to set the <b>Broadcast Packet Rate</b> below. Configure this parameter to limit the amount of broadcast packets that will be allowed on the ingress of the radio’s Ethernet port. Set the packets per second value to limit the impact of events such as broadcast storms.</p> <p><b>Disabled:</b> There is no limit on the amount of broadcast traffic that will be allowed into the ingress of the radio’s Ethernet port.</p>
<b>Broadcast Packet Rate</b>	<p>Set the packets per second value to limit the amount of broadcast traffic that will be allowed on the ingress on the radio’s Ethernet port. The packets per second limit can be set individually on each ePMP radio. The range is 100 to 16000 packets per second. The default is <b>200</b>.</p>
<b>Reliable Multicast</b>	<p><b>Enabled:</b> This feature allows ePMP to support IGMP capable devices. Once a multicast group is identified, the AP allows multicast traffic to be sent <b>only</b> to the SMs within the multicast group. The SMs support up to 5 unique multicast groups. In addition, when this option is enabled, the multicast traffic is sent to the SMs using the current Downlink MCS rate.</p> <p><b>Disabled:</b> ePMP will still support IGMP capable devices but the multicast traffic will be sent using MCS 1 on the downlink to all SMs, regardless of the multicast group.</p>

Attribute	Meaning
<b>IGMPv2 Fast Leave Support</b>	<p><b>Disabled:</b> <b>AP will not drop any IGMPv2 Leave packets</b></p> <p><b>Enabled:</b> AP will drop/ignore IGMPv2 Leave packets from SMs if there are other SMs downstream still subscribed to the IGMP group.</p>
Advanced	
<b>IPv6 Support</b>	<b>Systemwide IPv6 Protocol Support. When enabled, appropriate IPv6 modules and services will be loaded.</b>
<b>Spanning Tree Protocol</b>	<p><b>Disabled:</b> <b>When disabled, Spanning Tree Protocol (802.1d) functionality is disabled at the AP.</b></p> <p><b>Enabled:</b> <b>When enabled, Spanning Tree Protocol (802.1d) functionality is enabled at the AP, allowing for prevention of Ethernet bridge loops.</b></p>
<b>Management Access</b>	<p>Ethernet: <b>Only allow access to the AP's web management interface via a local Ethernet (LAN) connection. In this configuration, the AP's web management interface may not be accessed from over the air (i.e. from a device situated below the SM).</b></p> <p>Ethernet and Wireless: <b>Allow access to the AP's web management interface via a local Ethernet (LAN) connection and from over the air (i.e. from a device situated below the SM).</b></p> <hr/> <p> <b>Caution</b></p> <p><b>APs configured with AP Management Access Interface set to LAN and WLAN are susceptible to unauthorized access.</b></p>
<b>SM Traffic Isolation</b>	<p><b>Disabled:</b> This is the default mode. When SM isolation is disabled, an SM is able to communicate with another SM, when both the SM's are associated to the same Access Point (AP).</p> <p><b>Enabled:</b> When SM Isolation feature is "Enabled", SM#1 will not be able to communicate with SM#2 (peer-to-peer traffic) when both the SM's are associated with the same Access Point (AP). This feature essentially enables the AP to drop the packets to avoid peer-to-peer traffic scenario.</p>
<b>DHCP Option 82</b>	<p><b>Disabled:</b> When 'Disabled', ePMP does not insert the "remote-id" (option ID 0x2) and the "circuit-id" (ID 0x01). DHCP Option 82 is 'Disabled' by default.</p> <p><b>Enabled:</b> ePMP inserts "remote-id" (option ID 0x2) to be the SM's MAC address and the "circuit-id" (ID 0x01) to be the AP's MAC address. Those two fields are used to identify the remote device and connection from which the DHCP request was received.</p>
<b>LLDP</b>	<p>The Link Layer Discovery Protocol (LLDP) is a vendor-neutral link layer protocol (as specified in IEEE 802.1AB) used by ePMP for advertising its identity, capabilities, and neighbors on the Ethernet/wired interface.</p> <p><b>Disabled:</b> ePMP does not Receive or Transmit LLDP packets from/to its neighbors.</p> <p><b>Enabled:</b> ePMP can Receive LLDP packets from its neighbors and Send LLDP packets to its neighbors, depending on the <b>LLDP Mode</b> configuration below.</p> <hr/> <p> <b>Note</b></p> <p>LLDP packets are Received/Transmitted ONLY to the neighbors on the Ethernet Interface of the ePMP radio.</p>

---

Attribute	Meaning
<b>LLDP Mode</b>	<b>Receive and Transmit:</b> ePMP sends and receives LLDP packets to/from its neighbors on the Ethernet/LAN interface. <b>Receive Only:</b> ePMP receives LLDP packets from its neighbors on the Ethernet/LAN interface and discovers them.
<b>PPPoE Intermediate Agent</b>	When enabled, during the PPPoE Discovery phase the AP inserts access loop identification into the PPPoE PADR packets. This mechanism helps the service provider to distinguish between end hosts connected via Ethernet as an access device (typically, home routers situated below an ePMP subscriber device).  On the AP, PPPoE Intermediate Agent enables subscriber line identification by tagging Ethernet frames of corresponding users with Vendor Specific PPPoE Tags “Circuit ID” (defining AP name, frame, slot, port, and VLAN ID information) and “Remote ID” (defining user phone number).

---

### AP Security page

The AP's **Security** page is used to configure system security features including SM authentication and Layer2/Layer3 Firewall rules.



Caution

If a device firewall rule is added with **Action** set to **Deny** and **Interface** set to **LAN** or **WAN** and no other rule attribute are configured, the device will drop all Ethernet or wireless traffic, respectively. Ensure that all firewall rules are specific to the type of traffic which must be denied, and that no rules exist in the devices with only **Action** set to **Deny** and **Interface** set to **LAN** or **WAN**. To regain access to the device, perform a factory default.

Figure 49 AP Security page

The screenshot displays the 'Configuration > Security' page. It includes a left-hand navigation menu with options like Home, Quick Start, Configuration, Radio, Quality of Service, System, Network, Security (selected), Monitor, and Tools. The main content area is divided into several sections:

- Security Options:** Shows 'Wireless Security' with radio buttons for 'Open', 'WPA2', and 'RADIUS'. The 'WPA2' option is selected, and 'WPA2 Pre-shared Key' is visible.
- RADIUS:** Contains a table for 'Servers' with columns for IP Address, Port, and Secret. Below the table are fields for 'Server Radius' and 'Server Timeout', and radio buttons for 'GUI User Authentication' options.
- Firewall:** Divided into 'Layer 2 Firewall' and 'Layer 3 Firewall'. Each section has a table of 'Firewall Rules'.
 

Name	Action	Interface	Log	EtherType	VLAN ID	In MAC
Deny VLAN 100	Deny	LAN	Off		100	

Name	Action	Interface	Log	Priority	Port	In IP
Deny IP 10.120.2	Deny	LAN				10.120.210.100
- Wireless MAC Address Filtering:** Includes radio buttons for 'Wireless MAC Filter' (Enable/Disable) and 'Wireless MAC Filter Policy' (Prevent/Permit). Below is a table for 'Wireless MAC Filter List'.
 

MAC Address	Description
00:11:22:33:44:55	

© 2016 Cambium Networks, All Rights Reserved | Version 3.1 | Support | Community Forum

**Table 99** AP Security attributes

Attribute	Meaning
Security Options	
<b>Wireless Security</b>	<p>Open: <b>All SMs requesting network entry are allowed registration.</b></p> <p>WPA2: <b>The WPA2 mechanism provides AES radio link encryption and SM network entry authentication. When enabled, the SM must register using the Authentication Pre-shared Key configured on the AP and SM.</b></p> <p>RADIUS: <b>Enables the connection to a pre-configured RADIUS server.</b></p>
WPA2	
<b>WPA2 Pre-shared Key</b>	<b>Configure this key on the AP. Then configure each of the network SMs with this key to complete the authentication configuration. This key must be between 8 to 128 symbols.</b>
RADIUS	
<b>Servers</b>	<p><b>For more Radio servers, click Add. Up to 3 Radius servers can be configured on the device with the following attributes:</b></p> <p>IP Address: <b>IP Address of the Radius server on the network.</b></p> <p>Port: <b>The Radius server port. Default is 1812.</b></p> <p>Secret: <b>Secret key that is used to communicate with the Radius server.</b></p>
<b>Server Retries</b>	<b>Number of times the radio will retry authentication with the configured Radius server before it fails authentication of the SM.</b>
<b>Server Timeout</b>	<b>Timeout between each retry with the configured Radius server before it fails authentication of the SM.</b>
<b>GUI User Authentication</b>	<p><b>This applies to both the AP and its registered SMs.</b></p> <p>Device Local Only: <b>The device's GUI authentication is local to the device using one of the accounts configured under Configuration-&gt;System-&gt;Account Management.</b></p> <p>Remote RADIUS Server Only: <b>The device's GUI authentication is performed using a RADIUS server.</b></p> <p>Remote RADIUS Server and Fallback to Local: <b>The device's GUI authentication is performed using a RADIUS server. Upon failure of authentication through a RADIUS server, the authentication falls back to one of the local accounts configured under Configuration-&gt;System-&gt;Account Management.</b></p>
Firewalls	
<b>Layer 2 Firewall</b>	<p>Disabled: <b>Modifications to the Layer 2 Firewall Table are not allowed and rules are not enforced.</b></p> <p>Enabled: <b>Modifications to the Layer 2 Firewall Table are allowed and rules are enforced.</b></p>

Attribute	Meaning
<b>Firewall Rules</b>	<b>The Layer 2 firewall table may be used to configure rules matching layer 2 (MAC layer) traffic which result in forwarding or dropping the traffic over the radio link or Ethernet interface.</b>
<b>Layer 3 Firewall</b>	Disabled: <b>Modifications to the Layer 3 Firewall Table are not allowed and rules are not enforced.</b>  Enabled: <b>Modifications to the Layer 3 Firewall Table are allowed and rules are enforced.</b>
<b>Firewall Rules</b>	The Layer 3 firewall table may be used to configure rules matching layer 3 (IP layer) traffic which result in forwarding or dropping the traffic over the radio link or Ethernet interface.
Wireless MAC Address Filtering	
<b>Wireless MAC Filter</b>	Disabled: <b>SMs with any MAC Address are allowed to register to the AP.</b>  Enabled: <b>SMs with specific MAC address can be allowed (Permit) or denied (Prevent) registration with the AP as configured under the MAC Filter List.</b>
<b>Wireless MAC Filter Policy</b>	Prevent: <b>All MAC Addresses configured under the MAC Filter List are denied registration to the AP.</b>  Permit: <b>Only the MAC Addresses configured under the MAC Filter List are allowed to register to the AP.</b>
<b>Wireless MAC Filter List</b>	<b>Configure the SM's MAC addresses that will be permitted or prevented from registering to the AP.</b>
<b>MAC Address</b>	MAC Address of the SM
<b>Description</b>	Friendly description to identify the SM



## AP MONITOR MENU

Use the **Monitor** menu to access device and network statistics and status information. This section may be used to analyze and troubleshoot network performance and operation.

The **Monitor** menu contains the following pages:

- AP Performance page on page **162**
- AP System page on page 168
- **AP Wireless page** on page **170**
- **AP Throughput Chart page** on page **173**
- **AP GPS page** on page **173**
- **AP Network page** on page **176**
- AP System Log page on page 179

***AP Performance page***

Use the Performance page to monitor system status and statistics to analyze and troubleshoot network performance and operation.

Figure 50 AP Performance

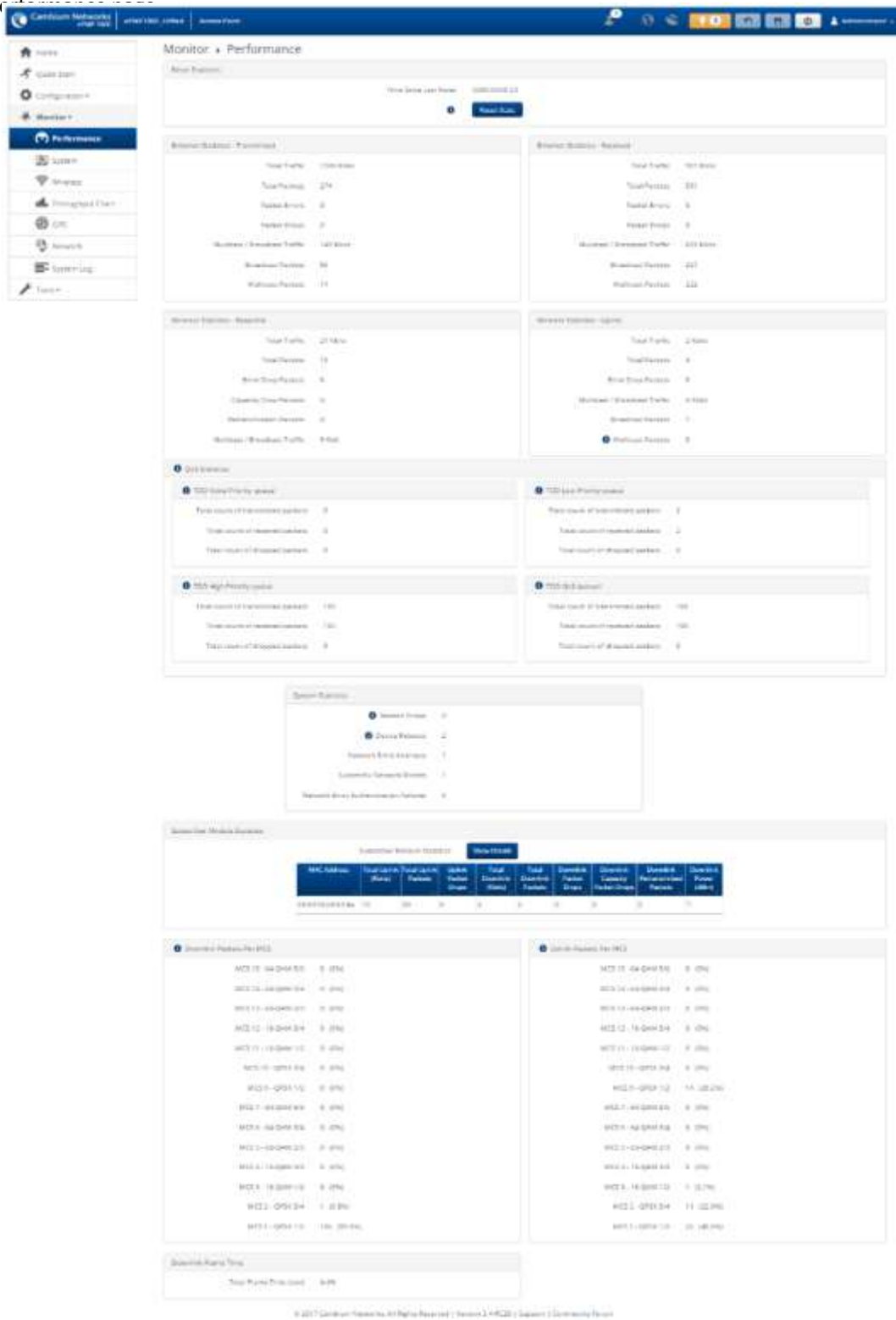

**Table 100** AP Performance page attributes

Attribute	Meaning
Time Since Last Reset	Time since the stats were last reset.
Ethernet Statistics - Transmitted	
Total Traffic	Total amount of traffic in Kbits transferred from the AP's Ethernet interface.
Total Packets	Total number of packets transferred from the AP's Ethernet interface.
Packet Errors	Total number of packets transmitted out of the AP's Ethernet interface with errors due to collisions, CRC errors, or irregular packet size.
Packet Drops	Total number of packets dropped prior to sending out of the AP's Ethernet interface due to Ethernet setup or filtering issues.
Multicast/Broadcast Traffic	Total amount of multicast and broadcast traffic in Kbits sent via the AP's Ethernet interface.
Broadcast Packets	Total number of broadcast packets sent via the AP's Ethernet interface.
Multicast Packets	Total number of multicast packets sent via the AP's Ethernet interface.
Ethernet Statistics - Received	
Total Traffic	Total amount of traffic in Kbits received by the AP's Ethernet interface.
Total Packets	Total number of packets received by the AP's Ethernet interface.
Packet Errors	Total number of packets received by the AP's Ethernet interface with errors due to collisions, CRC errors, or irregular packet size.
Packet Drops	Total number of packets dropped prior to sending out of the AP's wireless interface due to Ethernet setup or filtering issues.
Multicast/Broadcast Traffic	Total amount of multicast and broadcast traffic in Kbits received by the AP's Ethernet interface.
Broadcast Packets	Total number of broadcast packets received via the AP's Ethernet interface.
Multicast Packets	Total number of multicast packets received via the AP's Ethernet interface.
Wireless Statistics – Downlink	
Total Traffic	Total amount of traffic transmitted out of the AP's wireless interface in Kbits.
Total Packets	Total number of packets transmitted out of the AP's wireless interface.
Error Drop Packets	Total number of packets dropped after transmitting out of the AP's Wireless interface due to RF errors (No acknowledgement and other RF related packet error).
Capacity Drop Packets	Total number of packets dropped after transmitting out of the AP's Wireless interface due to capacity issues (data buffer/queue overflow or other performance or internal packet errors).
Retransmission Packets	Total number of packets re-transmitted after transmitting out of the AP's Wireless interface due to the packets not being received by the SMs.

Attribute	Meaning
Multicast / Broadcast Traffic	Total amount of multicast and broadcast traffic transmitted out of the AP's wireless interface in Kbits.
Broadcast Packets	Total number of broadcast packets transmitted out of the AP's wireless interface.
Multicast Packets	Total number of multicast packets transmitted out of the AP's wireless interface.
Wireless Statistics – Uplink	
Total Traffic	Total amount of traffic received via the AP's wireless interface in Kbits.
Total Packets	Total number of packets received via the AP's wireless interface.
Error Drop Packets	Total number of packets dropped prior to sending out of the AP's Ethernet interface due to RF errors (packet integrity error and other RF related packet error).
Multicast / Broadcast Traffic	Total amount of multicast and broadcast traffic received on the AP's wireless interface in Kbits.
Broadcast packets	Total number of broadcast packets received on the AP's wireless interface.
Multicast Packets	Total number of multicast packets received on the AP's wireless interface.
QoS Statistics	
TDD Voice Priority Queue	
Total count of transmitted packets	Total count of put packets to Voice queue
Total count of received packets	Total count of get packets from Voice queue
Total count of dropped packets	Total count of dropped packets from Voice queue
TDD High Priority Queue	
Total count of transmitted packets	Total count of put packets to High queue
Total count of received packets	Total count of get packets from High queue
Total count of dropped packets	Total count of dropped packets from High queue
TDD Low Priority Queue	
Total count of transmitted packets	Total count of put packets to Low queue
Total count of received packets	Total count of get packets from Low queue

Attribute	Meaning
Total count of dropped packets	Total count of dropped packets from Low queue
TDD QoS queues	
Total count of transmitted packets	Total count of put packets to all queues
Total count of received packets	Total count of get packets from all queues
Total count of dropped packets	Total count of dropped packets from all queues
System Statistics	
Session Drops	Total number of SM sessions dropped on the AP.
Device Reboots	Total number of reboots of the AP.
Network Entry Attempts	Total number of Network Entry Attempts by all the SMs on the AP.
Successful Network Attempts	Total number of successful network entry attempts.
Network Entry Authentication Failures	Total number of failed Network Entry Attempts by all the SMs on the AP.
Radar (DFS) Detections	Total number of DFS events that were detected by the AP.
Subscriber Module Statistics	
MAC Address	MAC Address of the SM connected to the AP.
Total Uplink	Total amount of traffic received via the AP's wireless interface from this SM in Kbits.
Total Uplink Packets	Total number of packets received via the AP's wireless interface from this SM.
Uplink Packet Drops	Total number of packets dropped prior to sending out of the AP's Ethernet interface due to RF errors (packet integrity error and other RF related packet error) from this SM.
Total Downlink	Total amount of traffic transmitted out of the AP's wireless interface in Kbits.
Total Downlink Packets	Total number of packets transmitted out of the AP's wireless interface.
Downlink Packet Drops	Total number of packets dropped after transmitting out of the AP's Wireless interface due to RF errors (No acknowledgement and other RF related packet error).
Downlink Capacity Packet Drops	Total number of packets dropped after transmitting out of the AP's Wireless interface due to capacity issues (data buffer/queue overflow or other performance or internal packet errors).
Downlink Retransmitted Packets	Total number of packets re-transmitted after transmitting out of the AP's Wireless interface due to the packets not being received by the SM.
Downlink Power	The transmit power of the AP for the downlink packets to the SM.

---

Attribute	Meaning
<hr/>	
Downlink Packets per MCS	
<hr/>	
MCS 0 through MCS 15	Number of packets (and percentage of total packets) transmitted out of the AP's wireless interface for every modulation mode used by the AP's transmitter, based on radio conditions.
<hr/>	
Uplink Packets per MCS	
<hr/>	
MCS 0 through MCS 15	Number of packets (and percentage of total packets) received on the AP's wireless interface for every modulation mode, based on radio conditions.
<hr/>	
Downlink Frame Time	
<hr/>	
Total Frame Time Used	Percentage of frame time used in the downlink.
<hr/>	
Uplink Frame Time	
<hr/>	
Total Frame Time Used	Percentage of frame time used in the uplink.
<hr/>	

### AP System page

Use the System Status page to reference key system information.

Figure 51 AP System Status page

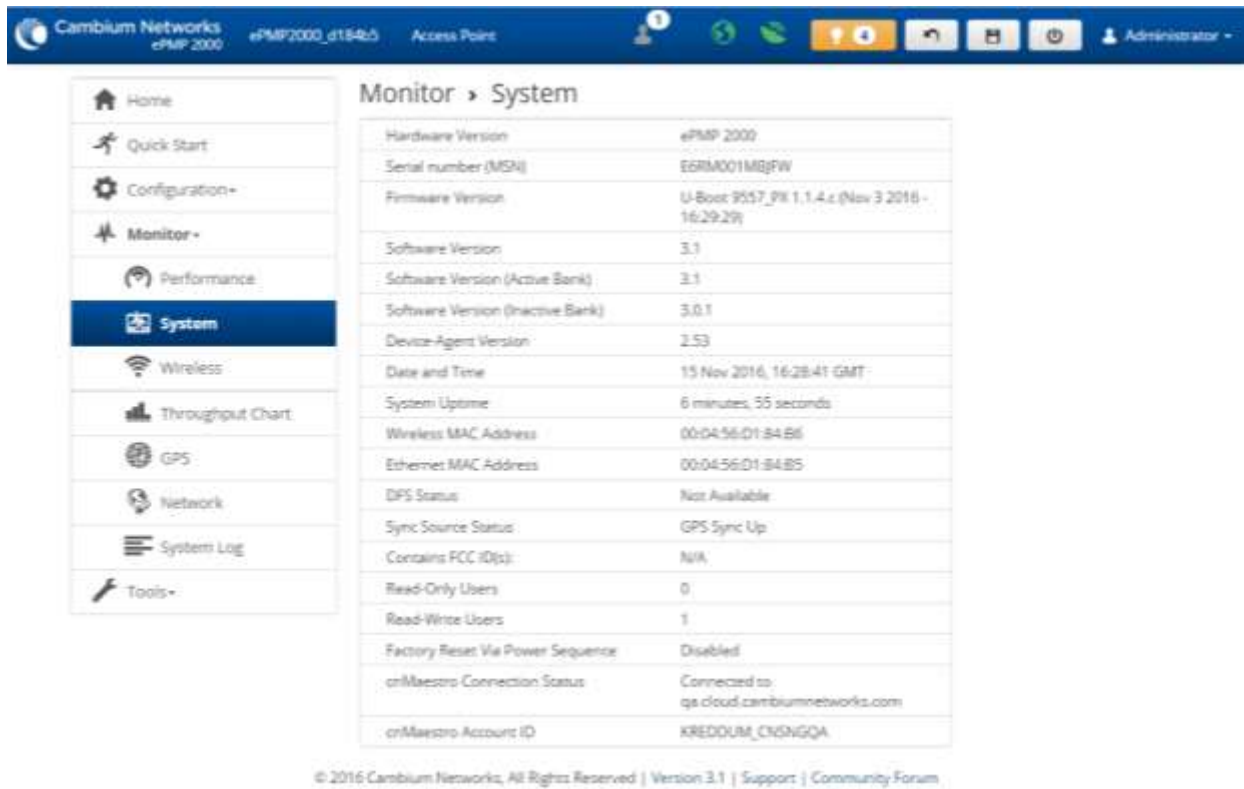

Table 101 AP System Status page attributes

Attribute	Meaning
Hardware Version	Board hardware version information.
Serial Number (MSN)	Serial Number information.
Firmware Version	U-Boot version information.
Software Version (Active Bank)	The currently operating version of software on the ePMP device.
Software Version (Inactive Bank)	The backup software version on the ePMP device, used upon failure of the active bank. Two software upgrades in sequence will update both the <b>Active Software Bank Version</b> and the <b>Inactive Software Bank Version</b> .
Device-Agent Version	The operating version of the device agent, which is used for communication with cnMaestro.
Date and Time	Current date and time, subject to time zone offsets introduced by the configuration of the device <b>Time Zone</b> parameter. Until a valid NTP server is configured, this field will display the time configured from the factory.
System Uptime	The total system uptime since the last device reset.
Wireless MAC Address	The hardware address of the device wireless interface.



Attribute	Meaning
Ethernet MAC Address	The hardware address of the device LAN (Ethernet) interface.
DFS Status	<p><b>N/A:</b> DFS operation is not required for the region configured in parameter <b>Country Code</b>.</p> <p><b>Channel Availability Check:</b> Prior to transmitting, the device must check the configured <b>Frequency Carrier</b> for radar pulses for 60 seconds). If no radar pulses are detected, the device transitions to state <b>In-Service Monitoring</b>.</p> <p><b>In-Service Monitoring:</b> Radio is transmitting and receiving normally while monitoring for radar pulses which require a channel move.</p> <p><b>Radar Signal Detected:</b> The receiver has detected a valid radar pulse and is carrying out detect-and-avoid mechanisms (moving to an alternate channel).</p> <p>In-Service Monitoring at Alternative Channel: The radio has detected a radar pulse and has moved operation to a frequency configured in DFS Alternative Frequency Carrier 1 or DFS Alternative Frequency Carrier 2.</p> <p><b>System Not In Service due to DFS:</b> The radio has detected a radar pulse and has failed channel availability checks on all alternative frequencies. The non-occupancy time for the radio frequencies in which radar was detected is 30 minutes.</p>
Sync Source Status	Displays the current source (GPS, CMM or Internal) of sync timing for the AP.
Read-Only Users	Displays the number of active Read-Only users logged into the radio.
Read-Write Users	Displays the number of active Read-Write users logged into the radio.
Factory Reset Via Power Sequence	<p><b>Enabled:</b> When Enabled under Tools-&gt;Backup/Restore-&gt;Reset Via Power Sequence, it is possible to reset the radio's configuration to factory defaults using the power cycle sequence explained under <b>Resetting ePMP to factory defaults by power cycling</b> on page <b>306</b>.</p> <p><b>Disabled:</b> When Disabled, it is not possible to factory default the radio's configuration using the power cycle sequence.</p>
cnMaestro Connection Status	The current management status of the device with respect to the Cambium Cloud Server. When Enabled under Configuration->System, the device will be managed by the Cambium Remote Management System, which allows all Cambium devices to be managed from the Cambium Cloud Server.
cnMaestro Account ID	The ID that the device is currently using to be managed by the Cambium Cloud Server.

### AP Wireless page

Use the **Wireless Status** page to reference key information about the radio's wireless interface and connected SMs.

**Figure 52** AP Wireless Status page (ePMP 2000 – List View)

The screenshot shows the 'Monitor > Wireless' page for an ePMP 2000. The summary section displays the following information:

- Operating Frequency: 3500 MHz
- Operating Channel Bandwidth: 40 MHz
- Transmitter Output Power: 0 dBm
- Device Initialization Status: Successful
- Registered Subscriber Modules: 10
- Ethernet Status: 1000 Mbps / Full
- Wireless Status: Up
- Country: Other

Below the summary is a table titled 'Registered Subscriber Modules' with a 'Show Detail' button. The table lists 10 modules with the following columns: Address, IP Address, Device Name, SIM Distance (miles), Session Time (H:MM:SS), RSSI (dBm) Downlink / Uplink, SNR (dB) Downlink / Uplink, MCS Downlink / Uplink, Downlink Quality, Downlink Capacity, MMR Profile, MMR Rate (Kbps) Downlink / Uplink, and Antenna Selected.

Address	IP Address	Device Name	SIM Distance (miles)	Session Time (H:MM:SS)	RSSI (dBm) Downlink / Uplink	SNR (dB) Downlink / Uplink	MCS Downlink / Uplink	Downlink Quality	Downlink Capacity	MMR Profile	MMR Rate (Kbps) Downlink / Uplink	Antenna Selected
000A:D6	10.120.224.107	ePMP1000_c00aD6	0	00:55:44	-45 / -72	45 / 26	15 / 15	100%	100%	0	10000 / 10000	Antenna 1
000B:0F	10.120.224.110	ePMP1000_c00b0F	0	00:55:41	-31 / -90	39 / 26	15 / 15	100%	100%	0	10000 / 10000	Antenna 1
000B:0F	10.120.224.115	ePMP1000_c00b0F	0	00:55:37	-43 / -40	47 / 26	7 / 15	100%	40%	0	10000 / 10000	Antenna 1
000B:63	10.120.224.112	ePMP1000_c00b63	0	00:55:36	-50 / -72	40 / 24	15 / 15	100%	100%	0	10000 / 10000	Antenna 1
000B:4C	10.120.224.114	ePMP1000_c00b4C	0	00:55:35	-25 / -37	61 / 39	15 / 15	100%	100%	0	10000 / 10000	Antenna 1
000B:CC	10.120.224.111	ePMP1000_c00bCC	0	00:55:33	-43 / -72	45 / 25	7 / 15	100%	40%	0	10000 / 10000	Antenna 1
000B:43	10.120.224.117	ePMP1000_c00b43	0.063	00:55:25	-28 / -54	63 / 41	7 / 15	100%	40%	0	10000 / 10000	Antenna 1
000D:F1	10.120.224.113	ePMP1000_c00dF1	0	00:55:22	-28 / -54	62 / 42	7 / 15	100%	40%	0	10000 / 10000	Antenna 1
000E:5D	10.120.224.106	ePMP1000_c00e5D	0	00:55:20	-27 / -53	63 / 43	15 / 15	100%	100%	0	10000 / 10000	Antenna 1
000E:60	10.120.224.108	ePMP1000_c00e60	0	00:55:19	-45 / -72	43 / 25	12 / 14	100%	100%	0	10000 / 10000	Antenna 1

**Figure 53** AP Wireless Status page (ePMP 1000 – Detail View)

The screenshot shows the 'Monitor > Wireless' page for an ePMP 1000. The summary section displays the following information:

- Operating Frequency: 3240 MHz
- Operating Channel Bandwidth: 20 MHz
- Transmitter Output Power: 19 dBm
- Device Initialization Status: Successful
- Registered Subscriber Modules: 2
- Registered ePMP Device Subscriber Modules: 0
- Ethernet Status: 100 Mbps / Full
- Wireless Status: Up
- Country: Other

Below the summary is a table titled 'Registered Subscriber Modules' with a 'Show Detail' button. The table lists 2 modules. The first module is selected, and its details are shown in a 'Details' panel:

Details	
MAC Address	00:04:58:c3:9b:0b
IP Address	10.120.108.55
IPv6 Address	N/A
Device Name	5GHz_ePMP_1000m_2E
SIM Distance (miles)	1.026
Session Time (H:MM:SS)	5 days 23:30:24
RSSI (dBm) Downlink / Uplink	-55 / -71
SNR (dB) Downlink / Uplink	30 / 15
MCS Downlink / Uplink	2 / 12
Downlink Quality	88%
Downlink Capacity	0%
MMR Profile	OFF
MMR Rate (Kbps) Downlink / Uplink	N/A / N/A

**Table 102** AP Wireless Status page attributes

Attribute	Meaning
Operating Frequency	The current frequency at which the AP is operating.
Operating Channel Bandwidth	The current channel size at which the AP is transmitting and receiving.
Transmitter Output Power	The current power level at which the AP is transmitting.
Device Initialization Status	This field indicate the status of the device initialization. Values are <b>Successful</b> and Error code for fail case. Please pay attention that in fail case device cannot be used in operating mode due to major hardware problem.
Registered Subscriber Modules	The total number of SMs which are currently registered to the AP.
Ethernet Interface	<b>Up:</b> The Ethernet (LAN) interface is functioning properly. <b>Down:</b> The Ethernet (LAN) interface has encountered an error and is not servicing traffic.
Wireless Interface	<b>Up:</b> The radio (WAN) interface is functioning properly. <b>Down:</b> The radio (WAN) interface has encountered an error and is not servicing traffic.
Country	The current country code at which the AP is operating.
Registered Subscriber Modules	Use the <b>Registered Subscriber Modules</b> table to monitor registered SMs, their key RF status and statistics information.
	Clicking this button deregisters the SM from the AP
MAC Address	The MAC address of the SM wireless interface.
IP Address	The IPv4 address of the SM wireless interface.
IPv6 Address	The IPv6 address of the SM wireless interface.
Device Name	Device Name of the SM
SM Distance (miles)	Distance of the SM from the AP
Session Time	Time duration for which the SM has been registered and in session with the AP.
RSSI (dBm) Downlink / Uplink	Current receive signal strength of the AP at the SM, in the downlink and the current receive signal strength of the SM at the AP, in the uplink. The downlink RSSI is an estimation. For accurate downlink RSSI, please refer to the SM's Dashboard page.
SNR (dB) Downlink / Uplink	Current Signal-to-Noise of the SM in the downlink and uplink
MCS Downlink / Uplink	Current MCS at which the SM is operating on the downlink and uplink
Downlink Quality	The downlink quality based on the current MCS and PER (Packet Error Rate) for this SM
Downlink Capacity	The downlink capacity based on the current DL MCS with respect to the highest supported MCS (MCS15). Not available in ePTP Master mode.
MIR Profile	Current MIR profile assigned to this SM "SERVER" indicates that the MIR values are assigned by the RADIUS server

---

Attribute	Meaning
MIR Rate (kbps) Downlink / Uplink	Current downlink and uplink MIR assigned to this SM in kbps
Antenna Selected	<p data-bbox="505 317 1354 380">Indicates the antenna for which uplink communication is conducted, <b>Sector</b> or <b>Smart Antenna</b>.</p> <p data-bbox="505 401 1354 537">When <b>Smart Antenna</b> is displayed, an indicator of the angle (in degrees) of the antenna pattern is also displayed. The <b>V</b> value represents vertical polarity and the <b>H</b> value represents horizontal polarity, both relative to boresight.</p> <div data-bbox="1187 453 1370 485" style="background-color: #90EE90; border-radius: 10px; padding: 2px; display: inline-block;">V -4° H 3°</div>

---

### AP Throughput Chart page

Use the Throughput page to reference a line chart visual representation of system throughput over time. The blue line indicates downlink throughput and the orange line indicates uplink throughput. The X-axis may be configured to display data over seconds, minutes, or hours, and the Y-axis is adjusted automatically based on average throughput. Hover over data points to display details.

Figure 54 AP Throughput Chart page

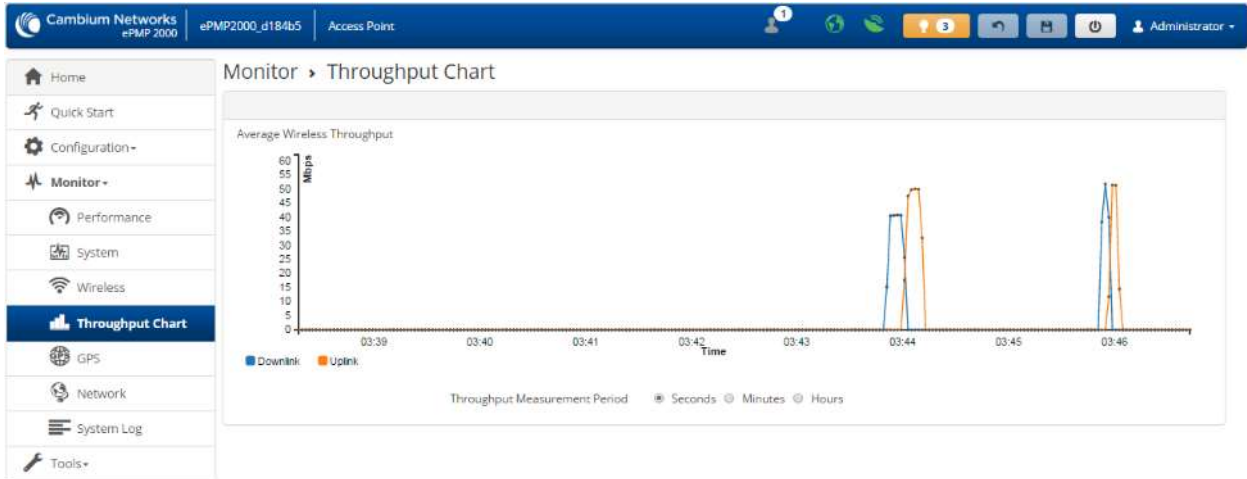

© 2016 Cambium Networks, All Rights Reserved | Version 3.1 | Support | Community Forum

Table 103 AP Throughput Chart page attributes

Attribute	Meaning
Throughput Measurement Period	Adjust the X-axis to display throughput intervals in seconds, minutes, or hours.

### AP GPS page

Use the GPS Status page to reference key information about the radio’s configured GPS coordinates.

Figure 55 AP GPS Status page

**Monitor > GPS Status**

On-board GPS Latitude	42.05337 degrees
On-board GPS Longitude	-088.02551 degrees
On-board GPS Height	241.3 meters
GPS Time (Greenwich Mean Time)	16:40:21
GPS Firmware Version	AXN_3.20_8174
Satellites Tracked	10
Satellites Visible	18

**Satellites** [Show Details](#)

ID	Signal-to-Noise Ratio	Status
5	44	Tracked
18	38	Tracked
13	42	Tracked
2	41	Tracked
15	42	Tracked
25	37	Tracked
29	40	Tracked
20	38	Tracked
21	45	Tracked
26	40	Tracked
51	38	Visible
65	0	Visible
88	0	Visible
87	16	Visible
72	22	Visible
66	0	Visible
81	16	Visible
80	0	Visible

**Table 104** AP GPS Status page attributes

Attribute	Meaning
On-board GPS Latitude	On a GPS Synchronized ePMP radio, the field is automatically populated with the Device Latitude information from the on-board GPS chip.
On-board GPS Longitude	On a GPS Synchronized ePMP radio, the field is automatically populated with the Device Longitude information from the on-board GPS chip.
On-board GPS Height	On a GPS Synchronized ePMP radio, the field is automatically populated with the Device height above sea level from the on-board GPS chip.
GPS Time (Greenwich Mean Time)	On a GPS Synchronized ePMP radio, the field is automatically populated with the time from the on-board GPS chip.
GPS Firmware version	On a GPS Synchronized ePMP radio, the field indicates the current firmware version of the on-board GPS chip.
Satellites Tracked	On a GPS Synchronized ePMP radio, the field indicates the number of satellites current tracked by the on-board GPS chip.
Satellites Visible	On a GPS Synchronized ePMP radio, the field indicates the number of satellites visible to the on-board GPS chip.
Satellites	The <b>Satellites</b> table provides information about each satellite that is visible or tracked along with the Satellite ID and Signal to Noise Ratio (SNR) of the satellite.
ID	Represents the Satellite ID.
Signal-to-Noise Ratio	This is an expression of the carrier signal quality with respect to signal noise.
Status	Status of each Satellite available.

### AP Network page

Use the AP Network Status page to reference key information about the device network status.

Figure 56 AP Network Status page

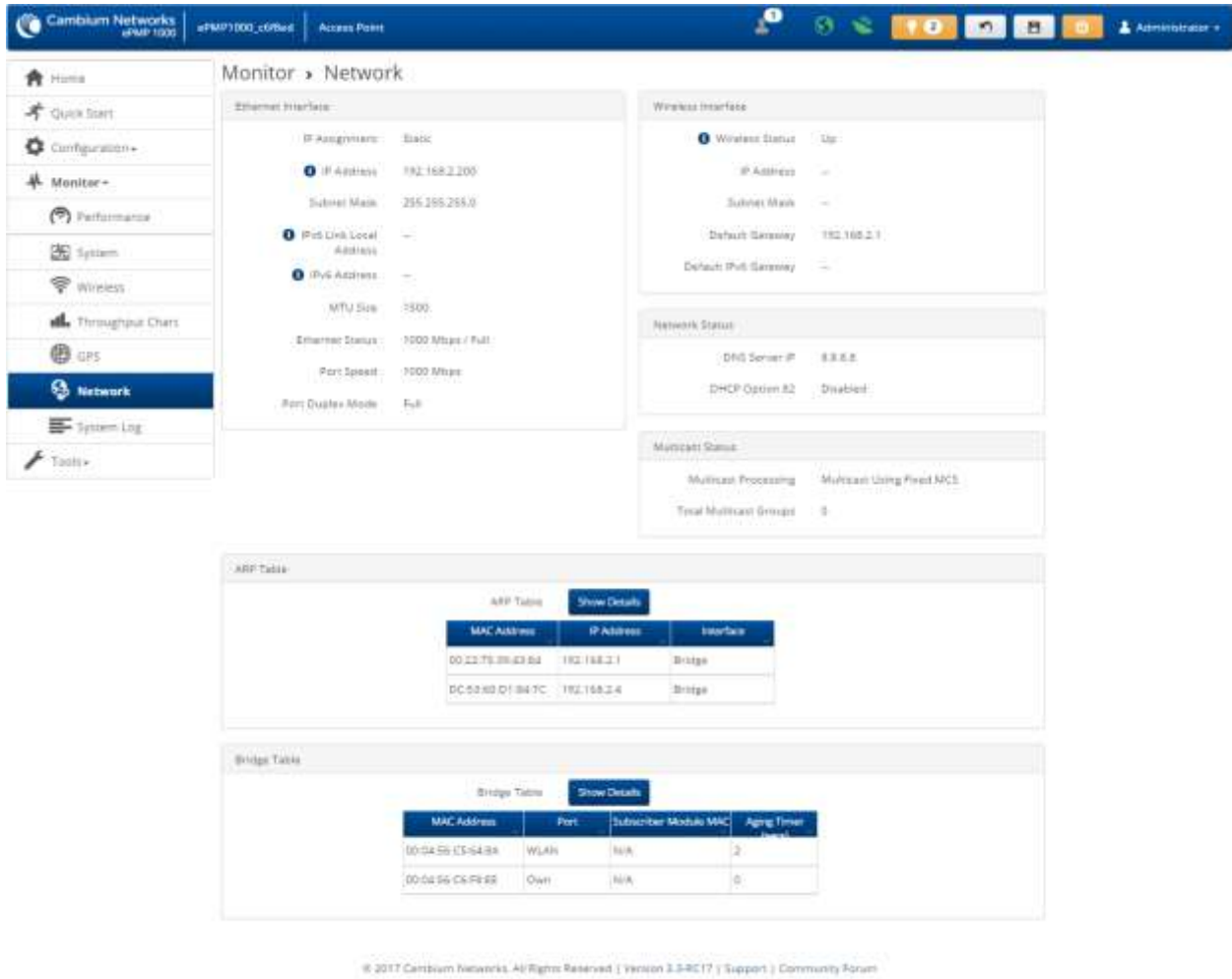

Table 105 AP Network Status page attributes

Attribute	Meaning
Ethernet Status	
IP Assignment	Static: <b>Device management IP addressing is configured manually in fields</b> Device IP Address (LAN), IP Subnet Mask (LAN), Gateway IP Address (LAN) <b>and</b> DNS Server IP Address (LAN).  DHCP: Device management IP addressing (IP address, subnet mask, gateway, and DNS server) is assigned via a network DHCP server, and parameters Device IP Address (LAN), IP Subnet Mask (LAN), Gateway IP Address (LAN), and DNS Server IP Address (LAN) are unused.
IP Address	The current IP Address mode of the device (static or DHCP).
Subnet Mask	The currently configured device IP subnet mask.



Attribute	Meaning
IPv6 Link Local Address	A link-local address is required for the IPv6-enabled interface (applications may rely on the link-local address even when there is no IPv6 routing). The IPv6 link-local address is comparable to the auto-configured IPv4 address 169.254.0.0/16.
IPv6 Address	The IPv6 address for device management.
MTU Size	The currently configured Maximum Transmission Unit for the AP's Ethernet (LAN) interface. Larger MTU configurations can enable the network to operate with greater efficiency, but in the case of retransmissions due to packet errors, efficiency is reduced since large packets must be resent in the event of an error.
Ethernet Status	<b>Up:</b> The device Ethernet interface is functioning and passing data. <b>Down:</b> The device Ethernet interface has encountered an error disallowing full operation. Reset the device to reinitiate the Ethernet interface.
Port Speed	The current Ethernet port speed of the radio.
Port Duplex Mode	The current Ethernet port duplex mode of the radio.
Wireless Status	
Wireless Interface	<b>Up:</b> The device wireless interface is functioning and passing data <b>Down:</b> The device wireless interface has encountered an error disallowing full operation. Reset the device to reinitiate the wireless interface.
IP address	Currently unused.
Subnet Mask	Currently unused.
Default Gateway	IP address that is currently assigned.
Network Status	
DNS Server IP	Represents the IP address of the DNS Server.
DHCP Option 82	<b>Enabled:</b> ePMP inserts "remote-id" (option ID 0x2) to be SM's MAC address and the "circuit-id" (ID 0x01) to be the AP's MAC address. Those two fields are used to identify the remote device and connection where the DHCP request was received and DHCP server can assign IP address accordingly. <b>Disabled:</b> When 'Disabled', AP passes the bootP traffic unaffected. DHCP Option 82 is 'Disabled' by default.
Multicast Status	
Multicast Processing	Displays the rate at which multicast traffic is sent on the downlink. <b>Multicast Using Fixed MCS:</b> Multicast traffic is sent to the SMs on the downlink at MCS 1. <b>Multicast Using Best MCS:</b> Multicast traffic is converted to unicast and sent to the SMs at the current MCS capability on the downlink.
Total Multicast Groups	Displays the current number of multicast groups that the AP has identified from IGMP devices connected to the registered SMs.
ARP Table	
MAC Address	MAC Address of the devices on the bridge.

---

Attribute	Meaning
IP Address	IP Address of the devices on the bridge.
Interface	Interface on which the AP identified the devices on.
Bridge Table	
MAC address	The hardware address of the AP.
Port	The port to which the device is connected.
Subscriber Module MAC	MAC Address for one of the connected SMS.
Aging Timer (secs)	Time set for the MAC addresses in the Bridge table.

---

## AP System Log page

Use the AP System Log page to view the device system log and to download the log file to the accessing PC/device.

**Figure 57** AP System Log page

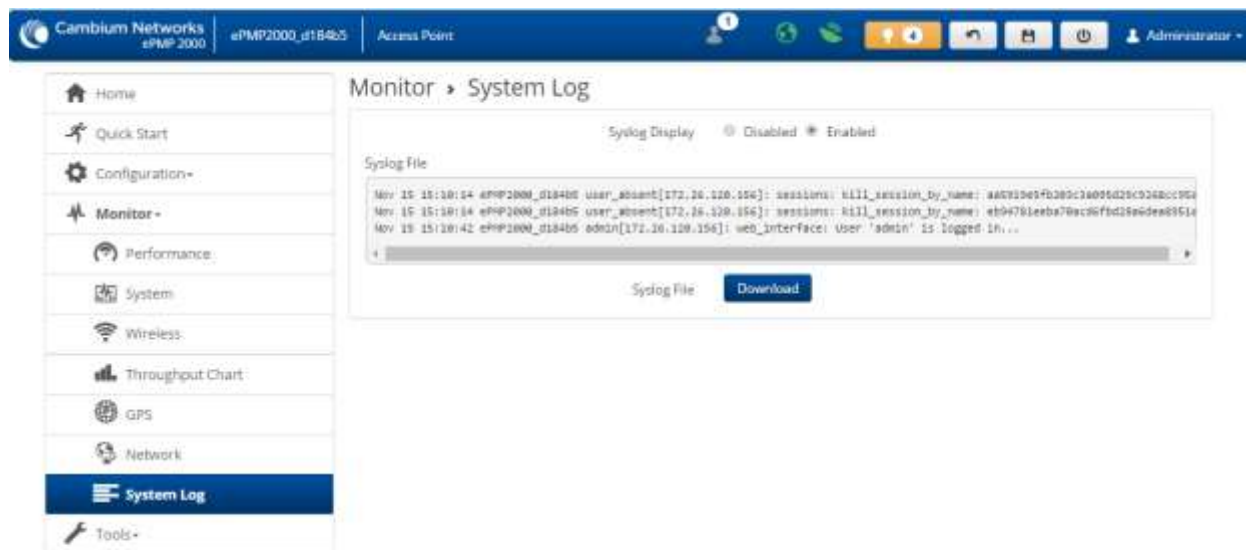

© 2016 Cambium Networks, All Rights Reserved | Version 3.1 | Support | Community Forum

**Table 106** AP System Log attributes

Attribute	Meaning
Syslog Display	<b>Enabled:</b> The system log file is displayed on the management GUI. <b>Disabled:</b> The system log file is hidden on the management GUI.
Download	Use this button to download the full system log file to a connected PC or device.

## AP TOOLS MENU

The AP **Tools** menu provides several options for upgrading device software, configuration backup/restore, analyzing RF spectrum, testing device throughput, and running ping and traceroute tests.

- AP Software Upgrade page on page 181
- AP Backup/Restore page on page 183
- **AP License Management** page on page 183
- AP eDetect page on page 183
- AP Spectrum Analyzer page on page 189
- AP Automatic Channel Selection page on page 192
- AP eAlign page on page 194
- AP Wireless Link Test page on page 196
- AP Ping page on page 197
- AP Traceroute page on page 199

**AP Software Upgrade page**

Use the AP **Software Upgrade** page to update the device radio software to take advantage of new software features and



**Caution**

Please read the Release Notes associated with each software release for special notices, feature updates, resolved software issues, and known software issues.

The Release Notes may be accessed at the [Cambium Support Center](#).

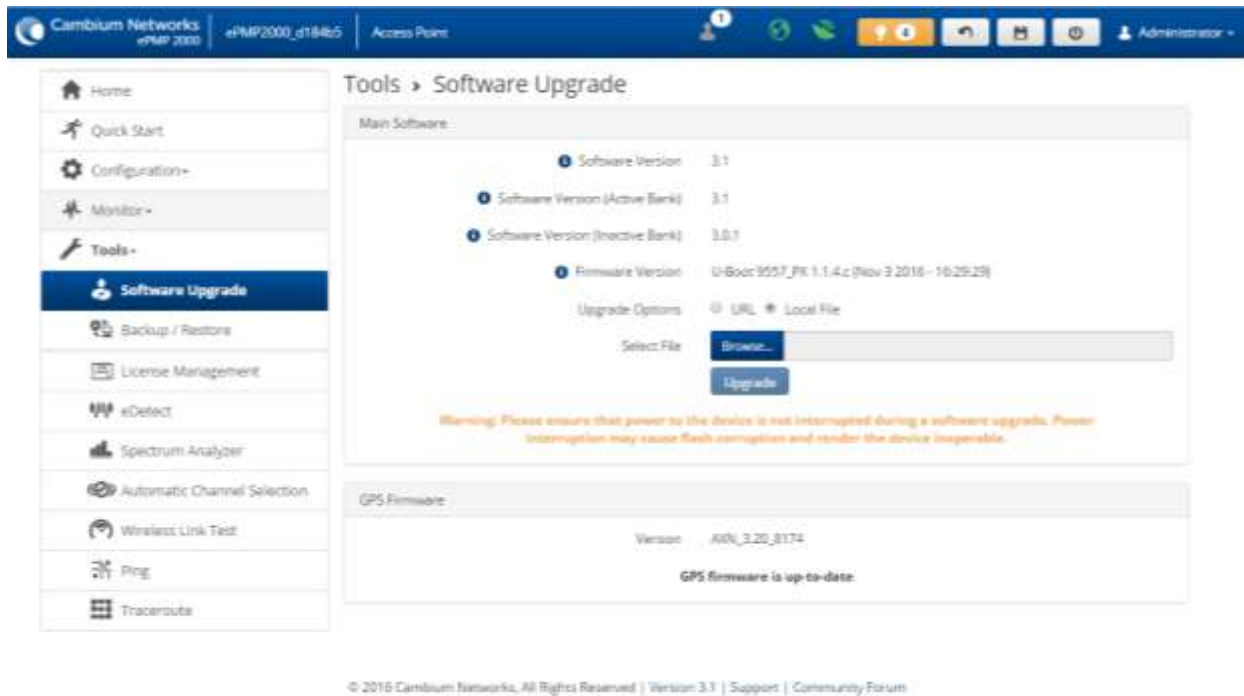

improvements.

**Figure 58** AP Software Upgrade page



**Table 107** AP Software Upgrade attributes

Attribute	Meaning
Main Software	
Software Version	ePMP boards that do not have an onboard GPS have one bank of flash memory which contains a version of software. The version of software last upgraded onto the Flash memory is present on this bank of flash memory. This software will be used by the AP when the AP is rebooted.

Attribute	Meaning
Software Version (Active Bank)	ePMP boards that have an onboard GPS have two banks of flash memory which each contain a version of software. The version of software last upgraded onto the Flash memory is made the Active Bank. This software will be used by the AP when the AP is rebooted.
Software Version (Inactive Bank)	ePMP boards that have an onboard GPS have two banks of flash memory which each contain a version of software. The version of software that was the Active Bank is made the Inactive Bank when another version of software is upgraded onto the Flash memory. The Inactive Bank of software will be used by the SM in case the Active Bank cannot be used due to a failure condition.
Firmware Version	The current U-Boot version.
Upgrade Options	<p><b>URL:</b> A webserver may be used to retrieve software upgrade packages (downloaded to the device via the webserver). For example, if a webserver is running at IP address 192.168.2.1 and the software upgrade packages are located in the home directory, an operator may select option <b>From URL</b> and configure the <b>Software Upgrade Source</b> field to <b>http://192.168.2.1/&lt;software_upgrade_package&gt;</b>.</p> <p><b>Local File:</b> Click Browse to select the local file containing the software upgrade package.</p>
Select File	Click <b>Browse</b> to select a local file (located on the device accessing the web management interface) for upgrading the device software.
<b>GPS Firmware</b>	
Firmware Version	<p>The current firmware of the on-board GPS chip (<b>AXN_1.51_2801</b> or <b>AXN_3.20_8174</b>).</p> <p>(1<sup>st</sup> Generation ePMP 1000 - Units purchased 2015 and prior) After upgrading, this version should show as <b>AXN_1.51_2838</b>.</p> <p>(2<sup>nd</sup> Generation ePMP 1000 and ePMP 2000 - Units purchased 2016 and after) After upgrading, this version should show as <b>AXN_5.1_8174</b>.</p>
Upgrade Options	<p><b>URL:</b> A webserver may be used to retrieve GPS firmware upgrade packages (downloaded to the device via the webserver). For example, if a webserver is running at IP address 192.168.2.1 and the firmware upgrade packages are located in the home directory, an operator may select option <b>From URL</b> and configure the <b>GPS Firmware Upgrade Source</b> field to <b>http://192.168.2.1/&lt;firmware_upgrade_package&gt;</b>.</p> <p><b>Local File:</b> Click Browse to select the local file containing the GPS firmware upgrade package.</p> <p> <b>Note</b></p> <p>If the “GPS Firmware Version” under Monitor=&gt;GPS Status shows “NOT AVAILABLE”, it means that the on-board GPS chip has locked up. A power cycle of the ePMP unit is required to restore the connectivity to the chip before performing the GPS firmware upgrade.</p>
Select File	<p>Click <b>Browse</b> to select a local file (located on the device accessing the web management interface) for upgrading the on-board GPS chip firmware.</p> <p> <b>Note</b></p> <p>Use the same package that is used to upgrade the device’s software. The new GPS firmware is part of the software upgrade packages.</p>

To upgrade the device software from a local file (or network-accessible file), follow this procedure:

**Procedure:**

- 1 Download the software upgrade packages from <https://support.cambiumnetworks.com/files/epmp>
- 2 Clear the accessing browser cache
- 3 On the device GUI, navigate to **Tools => Software Upgrade**.
- 4 Select the **Software Upgrade Source** which represents the location of your software upgrade packages
- 5 Based on the configuration of **Software Upgrade Source**, enter either the **Software Upgrade Source** or click the **Browse** button and locate the software package
- 6 Click Upgrade
- 7 When the upgrade completes successfully, click the **Reset** icon

To upgrade the GPS firmware from a local file (or network-accessible file), follow this procedure:

**Procedure:**

- 1 Download the software upgrade packages from <https://support.cambiumnetworks.com/files/epmp>
- 2 Clear the accessing browser cache
- 3 On the device GUI, navigate to **Tools => Software Upgrade**
- 4 Select the **Upgrade Options** under **GPS Firmware** which represents the location of your software upgrade packages
- 5 Based on the configuration of **GPS Firmware Source**, enter either the **Upgrade Source** or click the **Browse** button and locate the firmware package
- 6 Click Upgrade
- 7 When the upgrade completes successfully, click the **Reset** icon

### ***AP Backup/Restore page***

Use the AP Backup/Restore page to perform the following functions:

- Back up the configuration in either text (.json) format or binary (.bin) format.
- Restore the configuration of using a configuration file that was previously backed up.
- Reset the device to its factory default configuration. For more factory defaulting methods, see:
  - [Using the device external reset button](#) on page **304**
  - [Resetting ePMP to factory defaults by power cycling](#) on page **306**.

### ***AP License Management page***

The AP's **License Management** page is used to:

- Install licensing for ePMP Elevate subscriber access allotments
- Convert the AP from Lite (10 subscriber) to Full (120 subscriber)
- Configure the Country Code ETSI-locked devices

Beginning with Software Release 3.5.1, there are two types of ePMP Elevate license management mechanisms available on the ePMP device – Flexible and Fixed, described below:

**Figure 59** AP ePMP Elevate license management options

**Flexible Licensing**

With Flexible Licensing, your licenses are stored in a license server and can be shared among all your Access Points. Each Access Point will only use as many licenses as it has connected subscribers. When a subscriber disconnects, a license is returned to the pool and can be used by any other Access Point.

In order to use Flexible Licensing, your Access Points must:

- be able to make HTTPS requests out to the Internet,
- be running firmware version 3.5 or greater,
- have an accurate NTP time source.

[Use Flexible Licensing →](#)

**Fixed Licensing**

With Fixed Licensing, you will generate a license key for a specific MAC address, and load that license key into the Access Point. The license key represents the number of Elevate Subscribers that can be supported by that Access Point. The license key may not be transferred to any other Access Point.

You should use Fixed Licensing if your Access Points:

- are unable to make HTTPS requests to the Internet, or
- are running firmware version 3.4.1 or earlier, or
- don't have an accurate NTP time source.

[Use Fixed Licensing →](#)



**Note**

ePMP 3.4.1 and earlier Releases support only Fixed Licensing.

Elevate Flexible Licensing is available only for ePMP AP devices with GPS sync.

Country Code configuration for ETSI locked device and Full Capacity Keys for AP Lite devices are available only via Fixed License Management. Elevate is available via Fixed or Flexible License Management.



**Note**

To use flexible licensing, the AP must have DNS server access to be able to resolve URLs (and communicate with the license server). Also, the AP must have a valid, accurate time server (NTP) connection.



Figure 60 AP License Management page

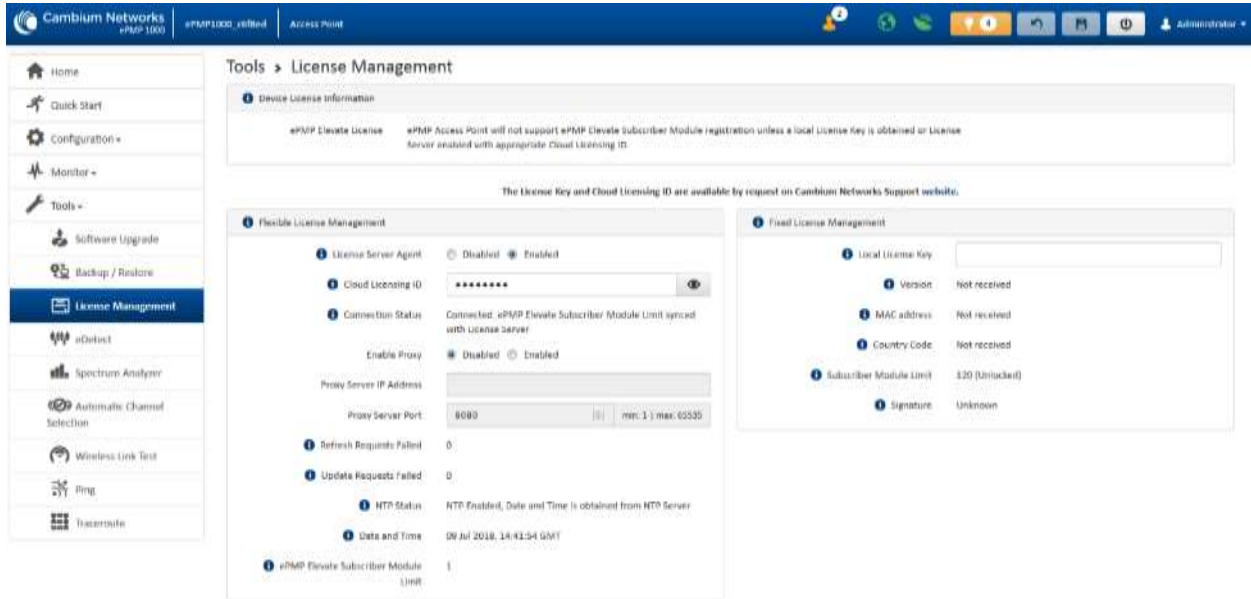

Table 108 AP License Management attributes

Attribute	Meaning
Flexible License Management	
License Server Agent	<p>Disabled: No communication with the License Server is established</p> <p>Enabled: Enables License Server functionality to obtain the number of allowed ePMP Elevate SMs to be connected to the AP</p>
Cloud Licensing ID	This field represents a Cambium Networks customer identification used for AP identification on the License Server. This identifier is generated upon License Entitlement activation at the Cambium Networks web-based Support Center.
Connection Status	The <b>Connection Status</b> displays the License Server process state when <b>License Server Agent</b> is <b>Enabled</b> . This status may also be referenced on the device <b>Home</b> page.
Enable Proxy	<p><b>Disabled:</b> The AP must have a valid internet connection to reach the license server</p> <p><b>Enabled:</b> A proxy server is specific for license server access from a private network</p>
Proxy Server IP Address	Specify the IP address of the proxy server used for internet access from a private network
Proxy Server Port	Specify the port used on the proxy server for internet access from a private network
Refresh Requests Failed	The number of failed refresh (polling) requests to the License Server. The <b>ePMP Elevate Subscriber Module Limit</b> resets to 1 after the 3 <sup>rd</sup> failed refresh request.
Update Requests Failed	The number of failed update (licensing information transfer) requests to the License Server. The <b>ePMP Elevate Subscriber Module Limit</b> resets to 1 after the 5 <sup>th</sup> failed updated request.
NTP Status	Represents whether or not the current time and date have been retrieved from the configured NTP server

---

Attribute	Meaning
ePMP Elevate Subscriber Module Limit	The number of ePMP Elevate devices allowed to register to the AP
Fixed License Management	
Local License Key	The "License Key" is obtained from support.cambiumnetworks.com and must be entered into this field to enable additional functionality (registration capacity, ePMP Elevate support) of the ePMP device.
Version	Specifies the licensing version scheme for the License Key
MAC address	The MAC Address is extracted from the License Key and must match the MAC Address of this device for the licenses to be enacted.
Country Code	A two character value representing the licensed country
Subscriber Module Limit	ePMP Lite / Force 110 devices are limited to 10 SMS in AP TDD mode. <b>SM Limit</b> will display <b>Unlocked</b> if a license is present which allows no limit of SMS to register to the device in AP TDD mode.
Signature	A valid License Key must have a valid signature included. The status is displayed after a License Key is entered and saved. Licenses can only be used if the signature is valid.

---

### AP eDetect page

The eDetect tool (not available in ePTP Master mode) is used to measure the 802.11 interference at the ePMP radio or system when run from the AP, on the current operating channel. When the tool is run, the ePMP device processes all frames received from devices not connected to the ePMP system and collects the interfering frame’s information such as MAC Address, RSSI, and MCS. Use the AP eDetect page to perform the following functions:

- Collect information about interferers system wide on the AP and the SMs connected to it to display on the APs GUI.
- Collect information about interferers locally at the AP only to display on the AP’s GUI.

Figure 61 AP eDetect page

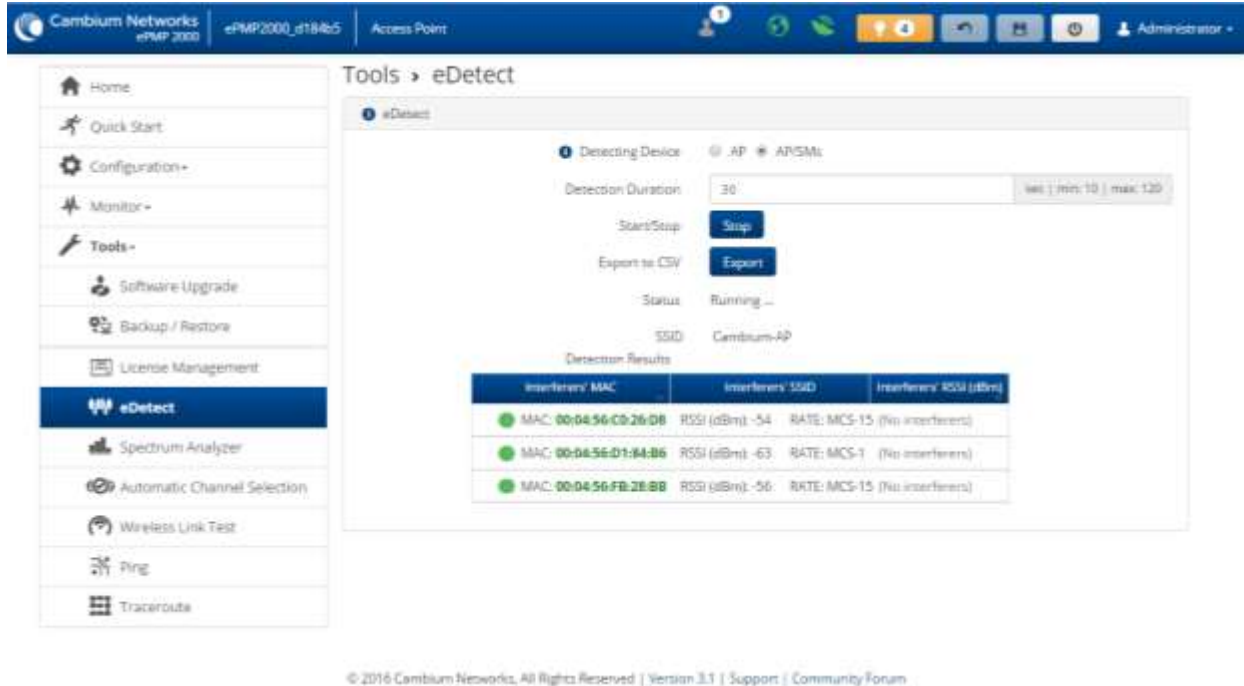



Table 109 AP eDetect attributes

Attribute	Meaning
Detecting Device	<b>AP:</b> Choosing this option will collect information about interferers local to the AP. <b>AP/SMs:</b> Choosing this option collect information about interferers system wide i.e. interferers local to the AP as well as interferers at the SMs connected to the AP.
Detection Duration	Configure the duration for which the AP (and SMs) scan for interferers.  <b>Caution</b> During the scanning period, the AP continues servicing the SMs under it, and there is no outage (unlike running a Spectrum Analyzer). There may be a negligible degradation in overall sector throughput.
Start/Stop	Use to start or stop the interference detection.
Export to CSV	Choose this option to export the detection results to .csv format.
Status	Current status of the Interference Detection tool.

Attribute	Meaning
SSID	The current configured name/SSID of the AP.
Detection Results	Use the <b>Detection Results</b> table to monitor interferers at the AP and at the registered SMs and their key RF parameters.
Device Instant Health	<p>This is an indicator of the device's health in terms of channel conditions in the presence of interferer(s).</p> <p><b>Green:</b> Indicates that the channel is relatively clean and has good C/I levels (&gt;25dB). The interference level is low.</p> <p><b>Yellow:</b> Indicates that the channel has moderate or intermittent interference (C/I between 10dB and 25dB).</p> <p><b>Red:</b> Indicates that the channel has high interference and poor C/I levels (&lt;10dB).</p>
Device MAC	The MAC address of the AP and/or SMs wireless interface.
Device RSSI (dBm)	The Received Signal Strength Indicator, which is a measurement of the power level being received by the device's antenna.
Device MCS	Modulation and Coding Scheme – indicates the modulation mode used for the radio's receiver side, based on radio conditions (MCS 1-7, 9-15).
Interferers' MAC	The MAC address of the interferer's wireless interface.
Interferers' RSSI (dBm)	The Received Signal Strength Indicator, which is a measurement of the interferer's power level being received by the device's antenna.
Interferers' MCS	Modulation and Coding Scheme – indicates the modulation mode used by the interferer, based on radio conditions (MCS 1-15).



#### Note

The system is operational when the eDetect tool is initiated. The detection is done during the transmission period within the TDD frame. And it is possible that the AP detects another AP on its back sector as an interferer when it is using the same frequency carrier in a GPS Synchronized system. Also, since the detection happens when the system is operational, there may be a negligible degradation in overall sector throughput when run from the AP.

## AP Spectrum Analyzer page

Use the AP Spectrum Analyzer page download the spectrum analyzer tool.

To download the spectrum analyzer tool, the AP **Device Mode** must be set to **Spectrum Analyzer**.

Java Runtime Environment is required to run the AP spectrum analyzer.

---



Caution

Conducting spectrum analysis causes the AP to enter scan mode and the AP drops all RF connections.

Vary the days and times when you analyze the spectrum in an area. The RF environment can change throughout the day or throughout the week.

### To conduct a spectrum analysis, follow this procedure:

Required Software:

- Java Run-time Environment (JRE)

### Procedure:

- 1 On the AP GUI, navigate to **Configuration => Radio**
- 2 Change the Radio Mode to Spectrum Analyzer
- 3 Click the **Save** button
- 4 Click the **Reset** button
- 5 Login to the AP GUI and navigate to **Tools => Spectrum Analyzer**.
- 6 Click Download Spectrum Analyzer Tool
- 7 Locate the folder to which the spectrum analyzer tool was saved and double-click on file `csa.jnlp` to launch the tool
- 8 If a security warning window appears, check the box next to *"I accept the risk and want to run this application"*

- 9 In the security warning window, click **Run**  
The spectrum analyzer interface is displayed

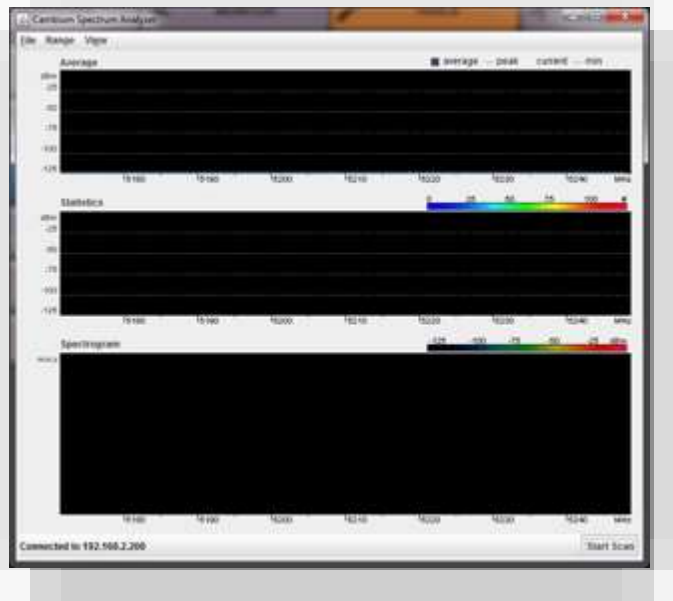

- 10 Click **Range** to configure the range of frequencies to scan.
- 11 Click **Start Scan** to begin scanning

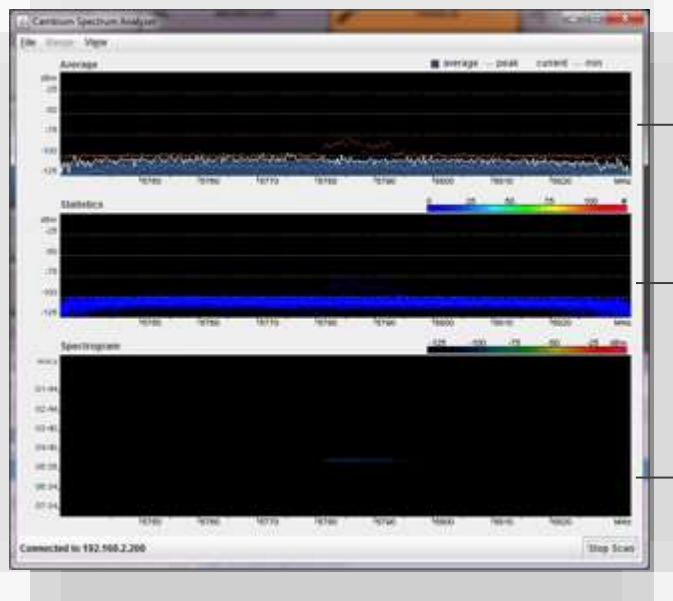

Display of the average, peak, current, and minimum power levels for the configured range

Statistical display of the number of times each frequency in the range was scanned

Spectrogram display of the energy levels detected throughout the configured range, over time

Once the scanning completes, follow these steps to return the device to AP operation:

**Procedure:**

- 1** In the spectrum analyzer application, click **Stop Scan**
- 2** Close the spectrum analyzer application by clicking **File => Exit**
- 3** On the AP GUI, navigate to **Configure => Radio**
- 4** Configure Device Mode to AP
- 5** Click the **Save** button
- 6** Click the **Reset** button

### AP Automatic Channel Selection page

Use the Automatic Channel Selection page to use the Automatic Channel Selection feature to allow the AP to choose the best channel possible under the current RF environment. This feature is not available when the AP is in ePTP Master mode.

Figure 62 AP Automatic Channel Selection

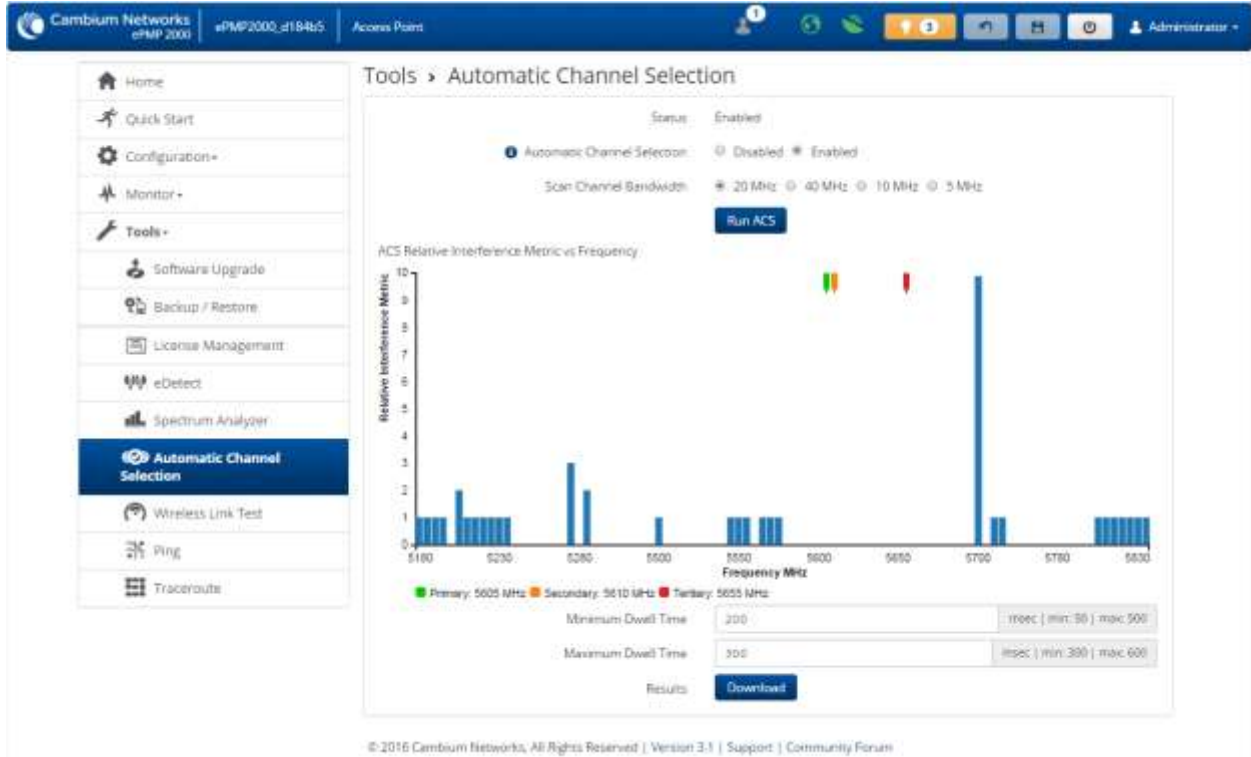



**Table 110** Automatic Channel Selection

Attribute	Meaning
Automatic Channel Selection	<p><b>Enabled</b> – This enables the Automatic Channel Selection (ACS) feature. ACS allows the radio to scan the entire band (governed by the <b>Country</b> setting) and chooses a channel with the lowest channel occupancy i.e. lowest interference level. To run the ACS feature (once enabled), the radio will have to be rebooted or manually triggered using Tools-&gt;Automatic Channel Selection. When ACS is running, the radio measures the occupancy level of the channel (measured in terms of an internal interference metric) and uses an algorithm to make a decision to choose the best channel within the band. The channel chosen is not based just on the occupancy level channel but also the occupancy level of adjacent channels.</p> <p><b>Disabled</b> – ACS is disabled and the operator should configure a <b>Frequency Carrier</b> manually.</p> <p> <b>Note</b></p> <p>The channel bandwidth configured prior to enabling and running ACS will be used to automatically select a channel. For ex: If the operator manually configured a channel bandwidth of 20MHz, ACS will scan and choose a channel of 20MHz wide channel. To switch ACS to 40MHz or other channel bandwidth, the operator should disable ACS, manually configure 40MHz or desired channel bandwidth on the radio, then enable and run ACS.</p>
Scan Channel Bandwidth	Configure the channel size for which the radio needs to scan the band.
Minimum Dwell Time	Configure the minimum time in milliseconds for which the radio needs to scan a channel to measure channel occupancy or interference levels. Default is 200 ms.
Maximum Dwell Time	Configure the maximum time in milliseconds for which the radio needs to scan a channel to measure channel occupancy or interference levels. Default is 300 ms.
Results	Click this button to download the most recent ACS results in .csv format.

**AP eAlign page**

Use the eAlign page to aid with link alignment.



Note

A valid link to an SM is required to provide meaningful RSSI measurements.

**Figure 63 AP eAlign**



© 2016 Cambium Networks, All Rights Reserved | Version 3.1 | Support | Community Forum

**Table 111 eAlign**

Attribute	Meaning
Operating Frequency	The current frequency at which the AP is operating.
Registered SM MAC Address	The MAC address of the SM that is registered to the AP.
Current RSSI	Current RSSI value measured on the uplink by the AP's receiver.
Peak RSSI	Peak RSSI value measured by the AP's receiver from the time the user navigated to the eAlign page.
Reset Measurements	Click this button to reset all current measurements.

**Caution**

ePMP supports Automatic Transmit Power Control (ATPC) where the SMs are instructed by the AP to adjust their Tx power in order for the SM's signal (UL RSSI) to arrive at the AP at a predetermined RSSI level (configurable on the AP under Configuration->Radio->Power Control->**Subscriber Module Target Receive Level**). This feature is beneficial to keep the overall noise floor in the sector to an acceptable level and is critical for deploying a GPS Synchronized system. However, the feature negates the purpose of eAlign measurements on the AP since, during the alignment, the SM may constantly change its Tx power. It is recommended to turn off ATPC and set the SM's Tx power to maximum allowable power during alignment.

While aligning the link using eAlign, please follow these steps:

**Procedure:**

- 1** On the SM, set Configuration->Radio->Power Control->Tx Power Manual Limit to **Max Tx Output Power**
- 2** Set Configuration->Radio->Power Control->Transmitter Output Power to **30 dBm** (or maximum value allowed by regulations).
- 3** Click the **Save** button
- 4** Perform link alignment using **eAlign**
- 5** Once alignment is complete, set Configuration->Radio->Power Control->Tx Power Manual Limit back to **Auto**
- 6** Click the **Save** button

### AP Wireless Link Test page

Use the AP Wireless Link Test page to conduct a simple test of AP wireless throughput to any one of the connected SMs. This allows user to determine the throughput that can be expected on a particular link without having to use external tools.

Figure 64 AP Wireless Link Test

The screenshot shows the ePMP 2000 web interface. The top navigation bar includes the Cambium Networks logo, the user's name (Zurich ePMP2000\_1110...), and the role (Access Point). The left sidebar contains various system management tools, with 'Wireless Link Test' highlighted. The main content area is titled 'Tools > Wireless Link Test' and contains a 'Test Setup' configuration panel and a 'Registered Subscriber Modules' table.

**Test Setup Configuration:**

- SM MAC Address: 00:04:5b:1e:05:01
- Packet Size:  Small (128 bytes)  Medium (800 bytes)  Large (1500 bytes)
- Duration:  4 seconds  10 seconds  20 seconds
- Uplink Antenna Selection:  Auto  Forced Sector Antenna  Forced Smart Antenna
- Start Test: [Start Test]
- Download: 41.758 Mbps
- Uplink: 5.754 Mbps
- Aggregate: 47.52 Mbps

**Registered Subscriber Modules:**

Registered Subscriber Modules [Show List]

Details	
MAC Address	00:04:5b:1e:05:01
IP Address	10.120.108.35
IPv6 Address	NA
Device Name	5GHz_ePMP_Antum_35
SM Distance (miles)	1.024
Session Time (h:mm:ss)	6 days 02:22:01
RSSI (dBm) Downlink / Uplink	-52 / -72
SINR (dB) Downlink / Uplink	33 / 16
MCS Downlink / Uplink	15 / 12
Downlink Quality	35%
Downlink Capacity	0%
MRR Profile	OFF
MRR Rate (kbps) Downlink / Uplink	N/A / N/A

**Table 112** AP Wireless Link Test attributes**AP Ping page**

Attribute	Meaning
Test Setup	
<b>SM MAC Address</b>	<b>Enter the MAC Address of one of the connected SMs or simply click the Select button of the SM desired in the “Registered Subscriber Modules” list.</b>
<b>Packet Size</b>	<b>Choose the Packet Size to use for the throughput test.</b>
<b>Duration</b>	<b>Choose the time duration in seconds to use for the throughput test.</b>
<b>Uplink Antenna Selection</b>	Uplink Antenna Selection <b>specifies the antenna to be used in the uplink for the wireless link test. The antenna cannot be forced if it is already configured to Forced Sector Antenna or Forced Smart Antenna in section Configuration &gt; Radio.</b>
<b>Downlink</b>	<b>This field indicates the result of the throughput test on the downlink, in Mbps.</b>
<b>Uplink</b>	<b>This field indicates the result of the throughput test on the uplink, in Mbps.</b>
<b>Aggregate</b>	<b>This field indicates the result of the aggregate throughput on the link, in Mbps. Displayed only when Downlink/Uplink Ratio is set to 75/25, 50/50 or 30/70.</b>
<b>Registered Subscriber Modules</b>	<b>Use the Registered Subscriber Modules table to monitor registered SMs and their key RF status and statistics information. Click Select on the SM that is desired to be used in the throughput test.</b>

Use the AP Ping page to conduct a simple test of AP IP connectivity to other devices which are reachable from the network. If no ping response is received or if “Destination Host Unreachable” is reported, the target may be down, there may be no route back to the AP, or there may be a failure in the network hardware (i.e. DNS server failure).

Figure 65 AP Ping page

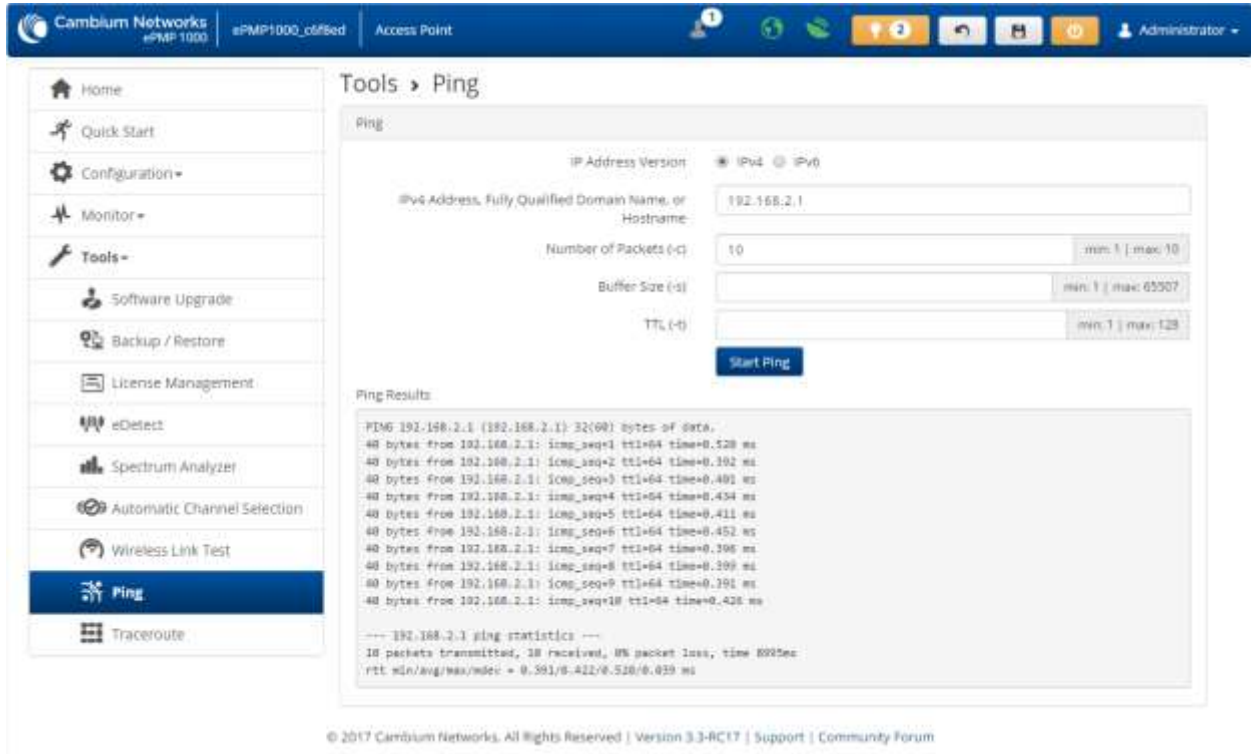

Table 113 AP Ping attributes

Attribute	Meaning
Ping	
IP Address Version	IPv4: The ping test is conducted via IPv4 protocol. IPv6: The ping test is conducted via IPv6 protocol.
IP Address	Enter the IP address of the ping target.
Number of packets (-c)	Enter the total number of ping requests to send to the target.
Buffer size (-s)	Enter the number of data bytes to be sent.
TTL (-t)	Set the IP Time-To-Live (TTL) for multicast packets. This flag applies if the ping target is a multicast address.
Ping results	Results of the Ping test are displayed in the box.

### AP Traceroute page

Use the AP Traceroute page to display the route (path) and associated diagnostics for IP connectivity between the AP and the destination specified.

Figure 66 AP Traceroute page

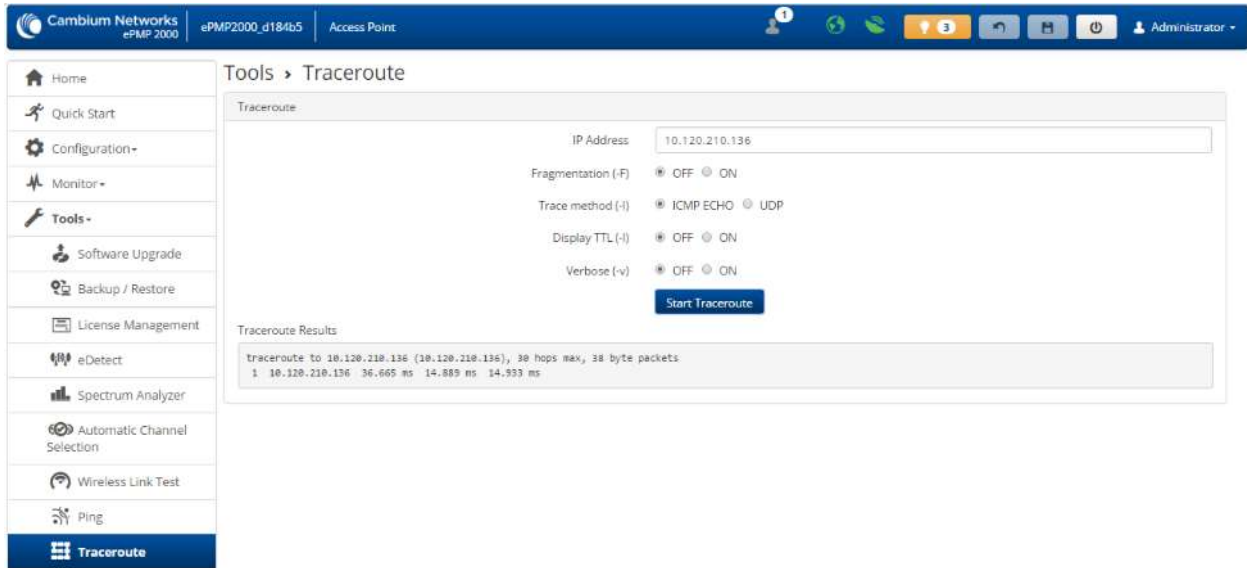

© 2016 Cambium Networks, All Rights Reserved | Version 3.1 | Support | Community Forum

Table 114 AP Traceroute attributes

Attribute	Meaning
Traceroute	
<b>IP Address</b>	<b>Enter the IP address of the target of the traceroute diagnostic.</b>
<b>Fragmentation (-F)</b>	<b>ON: Allow source and target to fragment probe packets.</b> <b>OFF: Do not fragment probe packets (on source or target).</b>
<b>Trace method (-I)</b>	<b>ICMP ECHO: Use ICMP ECHO for traceroute probes.</b> <b>UDP: Use UDP for traceroute probes.</b>
<b>Display TTL (-I)</b>	<b>ON: Display TTL values for each hop on the route.</b> <b>OFF: Suppress display of TTL values for each hop on the route.</b>
<b>Verbose (-v)</b>	<b>ON: ICMP packets other than TIME_EXCEEDED and UNREACHABLE are displayed in the output.</b> <b>OFF: Suppress display of extraneous ICMP messaging.</b>
<b>Traceroute Results</b>	<b>Traceroute test results are displayed in the box.</b>

## Using the SM menu options

Use the menu navigation bar in the top and left panels to navigate to each web page. The functional area that may be accessed from each menu option is listed under [Table 91](#). Some of the parameters are only displayed for specific system configurations.

**Table 115** Functional areas accessed from each SM menu option

Menu option	Menu Details
Quick Start	<a href="#">Configuring SM units using the Quick Start menu</a> on page <a href="#">128</a>
Configuration	SM Configuration menu on page 201
Radio	SM Radio page on page 202
Quality of Service	<a href="#">SM Quality of Service page</a> on page <a href="#">206</a>
System	<a href="#">SM System page</a> on page <a href="#">211</a>
Network	<a href="#">SM Network page</a> on page <a href="#">216</a>
Security	SM Security page on page 243
Monitor	SM Monitor menu on page 246
Performance	SM Performance page on page 247
System Status	SM System page on page 251
Wireless Status	<a href="#">SM Wireless page</a> on page <a href="#">252</a>
Throughput Chart	<a href="#">SM Throughput Chart page</a> on page <a href="#">256</a>
Network Status	<ul style="list-style-type: none"> <li>• <a href="#">SM Network page</a> on page <a href="#">256</a></li> </ul>
System Log	<a href="#">SM System Log page</a> on page <a href="#">266</a>
Tools	SM Tools menu on page 267
Software Upgrade	SM Software Upgrade page on page 268
Backup / Restore	SM Backup / Restore page on page 271
eDetect	SM eDetect page on page 273
Spectrum Analyzer	SM Spectrum Analyzer page on page 275
eAlign	SM eAlign page on page 277
Wireless Link Test	SM Wireless Link Test page on page 278
Ping	SM Ping page on page 278
Traceroute	SM Traceroute page on page 279



## SM CONFIGURATION MENU

Use the **Configuration** menu to access all applicable device configuration parameters. It contains the following pages:

- SM Radio page on page 202
- **SM Quality of Service page** on page **206**
- **SM System page** on page **211**
- **SM Network page** on page **216**
- **SM Security page** on page **243**

### SM Radio page

Use the Radio page to configure the device radio interface parameters.



Caution

Modifying radio parameters may result in a wireless outage. Plan configuration modifications accordingly.

Figure 67 SM Radio page (TDD or ePTP Slave mode)

The screenshot displays the 'Configuration > Radio' page in the Cambium Networks ePMP 1000 web interface. The interface is divided into several sections:

- General:** Includes 'Radio Mode' (with sub-options: Access Point, Subscriber Module, Spectrum Analyzer), 'Driver Mode', 'Country' (set to 'Yellow AP's Country'), and 'Range Unit' (Miles/Kilometers).
- Preferred APs:** A table with columns for SSID, Wireless Security, and WPA2 Pre-shared Key. The table is currently empty.
- Subscriber Module Scanning:** Features 'Scan Channel Bandwidth' options (5 MHz, 10 MHz, 20 MHz, 40 MHz) and 'Scan List' options (20 MHz Scan List, 40 MHz Scan List). A 'Radio Frequency 40 MHz Scan List' is visible with 'Unselect All' and 'Select All' buttons.
- Power Control:** Contains settings for 'Max Tx Power' (Auto/Manual), 'Transmiter Output Power' (30 dBm), 'Antenna Gain' (1.2 dBi), 'Network Entry RSSI Threshold' (-80 dBm), 'Network Entry SNR Threshold' (0 dB), and 'Uplink Antenna Selection' (Auto/Forced Sector Antenna/Forced Smart Antenna).
- Scheduler:** Includes 'Uplink Max Rate' set to 'MCS 10 - 64-QAM 3/4'.

At the bottom of the page, the footer reads: '© 2017 Cambium Networks. All Rights Reserved | Version 3.0-RC16 | Support | Community Forum'.

**Table 116** SM Radio Configuration attributes (TDD mode or ePTP Slave mode)

Attribute	Meaning
<b>General</b>	
Radio Mode	This parameter controls the function of the device – All ePMP devices may be configured to operate as an <b>Access Point (AP)</b> , <b>Subscriber Module (SM)</b> or as a <b>Spectrum Analyzer</b> .
Driver Mode	This parameter controls the wireless mode of operation of the SM.  <b>TDD:</b> The SM is operating in the proprietary TDD mode and will only connect to another ePMP Access Point.  <b>Standard WiFi:</b> The SM is operating in the Standard 802.11n WiFi mode and will be able to connect to any Access Point operating in standard 802.11n WiFi mode.  <b>ePTP Slave:</b> The SM is operating as a Slave in point-to-point mode. The AP and the system do not support GPS Synchronization in this mode but are able to provide <b>significantly lower latency</b> than other modes. QoS (MIR and traffic priority) capability and Link Quality/Capacity indicators are not available in this mode.
Country	The SM automatically inherits the Country Code setting of the AP (except for US-locked devices).  <b>Country</b> settings affect the radios in the following ways: <ul style="list-style-type: none"> <li>• Maximum transmit power limiting (based on radio transmitter power plus configured antenna gain)</li> <li>• DFS operation is enabled based on the configured country code, if applicable</li> <li>• Frequency selection is based on local regulatory limits</li> </ul>
Range Unit	The unit of measurement used for reporting <b>Distance from AP</b> .
<b>Preferred AP List</b>	
Preferred APs	The <b>Preferred AP List</b> is comprised of a list of up to 16 APs to which the SM sequentially attempts registration. For each AP configured, if authentication is required, enter a <b>Pre-shared Key</b> associated with the configured <b>AP SSID</b> . When the SM is in <b>Standard WiFi</b> mode, the SMs will actively probe the SSIDs in this list to find APs with hidden SSIDs.
<b>Subscriber Module Scanning</b>	

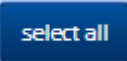
Attribute	Meaning
Scan Channel Bandwidth	<p>Click the  button to unselect all channel bandwidths. The SM will not scan for any frequencies.</p> <p>Click the  button to select all channel bandwidths. The SM will scan all channel bandwidths, i.e. 5 MHz, 10 MHz, 20 MHz and 40 MHz.</p> <p>Alternately choose individual channel bandwidth tabs and/or frequencies within each channel bandwidth tab for a customized scan list.</p>
Power Control	
Max Tx Power	<p><b>Auto:</b> The Access Point can control, using ATPC (Automatic Transmit Power Control), the TX power of the SM up to the maximum capability of the SM's transmitter (based on regulatory limits).</p> <p><b>Manual:</b> The Access Point can control the TX power of the SM up to the value configured in the <b>Transmitter Output Power</b> field below.</p>
Transmitter Output Power	When <b>Manual</b> is selected, the SM will not transmit higher than the configured value in the field. Determines the maximum output power of the transmitter. The actual output power may be lower due to Automatic Transmit Power Control (ATPC), where the AP instructs the SM to lower its power to meet the SM target Receive Level configured on the AP.
Antenna Gain	This value represents the amount of gain introduced by the unit's internal antenna. This parameter is read-only for Integrated radios.
Network Entry RSSI Threshold	Set this parameter to the minimum Received Signal Strength Indicator (RSSI) at the SM required for the SM to attempt registration to an AP. For example, if the <b>AP RSSI Threshold</b> is set to -80 dBm, and the SM is receiving the AP signal at -85 dBm (RSSI = -85 dBm), the SM will not attempt to register to the AP.
Network Entry SNR Threshold	Set this parameter to the minimum Signal-to-Noise Ratio (SNR) at the SM required for the SM to attempt registration to an AP. For example, if the <b>AP SNR Threshold</b> is set to 30 dB and the SM is calculating its DL SNR as 25 dB, the SM will not attempt to register to the AP.

Attribute	Meaning
Uplink Antenna Selection	<p><b>Uplink Antenna Selection</b> specifies the antenna to be used in the uplink. This parameter is specific to SMs registered to ePMP 2000 APs configured with an optional Smart Antenna.</p> <p><b>Auto:</b> The AP decides which antenna to use (sector or Smart Antenna) for uplink communications based on internal quality metrics.</p> <p><b>Forced Sector Antenna:</b> The AP uses the Sector Antenna for uplink communications with SMs configured with this option</p> <p><b>Forced Smart Antenna:</b> The AP uses the smart antenna for uplink communications with SMs configured with this option</p>
<div style="background-color: #f0f0f0; padding: 10px;">  <b>Note</b>  <p>If the AP is configured with <b>Uplink Antenna Selection</b> set to <b>Auto</b> and an SM is set to <b>Forced Sector Antenna</b> or <b>Forced Smart Antenna</b>, the SM setting will be enforced.</p> <p>If the AP is configured with <b>Uplink Antenna Selection</b> set to <b>Forced Sector Antenna</b> or <b>Forced Smart Antenna</b> and a SM is set to a conflicting <b>Forced</b> setting, the AP's setting will be enforced.</p> </div>	
Scheduler	
Uplink Max Rate	<p>Configure the MCS (Modulation and Coding Scheme) rate beyond which the radio's scheduler should not exceed when transmitting data traffic on the uplink. This is useful in situations where there is high variance and unpredictability in the interference present in the environment causing packet loss. Reducing the max rate to a lower MCS (than the default MCS 15) may help in these situations. Reducing the Uplink Max Rate will result in reduced throughput capacity of the SM in the uplink. Not available when SM is in <b>ePTP Slave</b> or <b>Standard WiFi</b> mode.</p>

Figure 68 SM Radio page (Standard WiFi mode)

The screenshot displays the configuration interface for the Radio section of a Cambium Networks ePMP 1130 SM Subscriber Module. The interface includes a navigation sidebar on the left and a main configuration area on the right.

**Configuration > Radio**

**General**

- Radio Mode:  Access Point,  Subscriber Module,  Spectrum Analyzer
- Driver Mode:  TDD,  Standard WiFi,  eFTP Slave
- Failback Country: United States
- Range Unit:  Miles,  Kilometers

**Preferred APs**

Buttons: Add new AP, Show Details

SSID	Wireless Security	WPA2 Pre-shared Key
Table is empty		

**Subscriber Module Scanning**

Scan Channel Bandwidth:  5 MHz,  10 MHz,  40 MHz,  20 MHz

20 MHz Scan List:  40 MHz Scan List

Radio Frequency 40 MHz Scan List:

<input type="checkbox"/> 4830 MHz	<input type="checkbox"/> 4835 MHz	<input type="checkbox"/> 4840 MHz	<input type="checkbox"/> 4845 MHz	<input type="checkbox"/> 4850 MHz	<input type="checkbox"/> 4855 MHz	<input type="checkbox"/> 4860 MHz	<input type="checkbox"/> 4865 MHz
<input type="checkbox"/> 4870 MHz	<input type="checkbox"/> 4875 MHz	<input type="checkbox"/> 4880 MHz	<input type="checkbox"/> 4885 MHz	<input type="checkbox"/> 4890 MHz	<input type="checkbox"/> 4895 MHz	<input type="checkbox"/> 4900 MHz	<input type="checkbox"/> 4905 MHz
<input type="checkbox"/> 5010 MHz	<input type="checkbox"/> 5015 MHz	<input type="checkbox"/> 5020 MHz	<input type="checkbox"/> 5025 MHz	<input type="checkbox"/> 5030 MHz	<input type="checkbox"/> 5035 MHz	<input type="checkbox"/> 5040 MHz	<input type="checkbox"/> 5045 MHz
<input type="checkbox"/> 5050 MHz	<input type="checkbox"/> 5055 MHz	<input type="checkbox"/> 5060 MHz	<input type="checkbox"/> 5065 MHz	<input type="checkbox"/> 5070 MHz	<input type="checkbox"/> 5075 MHz	<input type="checkbox"/> 5080 MHz	<input type="checkbox"/> 5085 MHz
<input type="checkbox"/> 5090 MHz	<input type="checkbox"/> 5095 MHz	<input type="checkbox"/> 5100 MHz	<input type="checkbox"/> 5105 MHz	<input type="checkbox"/> 5110 MHz	<input type="checkbox"/> 5115 MHz	<input type="checkbox"/> 5120 MHz	<input type="checkbox"/> 5125 MHz
<input type="checkbox"/> 5130 MHz	<input type="checkbox"/> 5135 MHz	<input type="checkbox"/> 5140 MHz	<input type="checkbox"/> 5145 MHz	<input type="checkbox"/> 5150 MHz	<input type="checkbox"/> 5155 MHz	<input type="checkbox"/> 5160 MHz	<input type="checkbox"/> 5165 MHz
<input type="checkbox"/> 5170 MHz	<input type="checkbox"/> 5175 MHz	<input type="checkbox"/> 5180 MHz	<input type="checkbox"/> 5185 MHz	<input type="checkbox"/> 5190 MHz	<input type="checkbox"/> 5195 MHz	<input type="checkbox"/> 5200 MHz	<input type="checkbox"/> 5205 MHz
<input type="checkbox"/> 5210 MHz	<input type="checkbox"/> 5215 MHz	<input type="checkbox"/> 5220 MHz	<input type="checkbox"/> 5225 MHz	<input type="checkbox"/> 5230 MHz	<input type="checkbox"/> 5235 MHz	<input type="checkbox"/> 5240 MHz	<input type="checkbox"/> 5245 MHz
<input type="checkbox"/> 5250 MHz	<input type="checkbox"/> 5255 MHz	<input type="checkbox"/> 5260 MHz	<input type="checkbox"/> 5265 MHz	<input type="checkbox"/> 5270 MHz	<input type="checkbox"/> 5275 MHz	<input type="checkbox"/> 5280 MHz	<input type="checkbox"/> 5285 MHz
<input type="checkbox"/> 5290 MHz	<input type="checkbox"/> 5295 MHz	<input type="checkbox"/> 5300 MHz	<input type="checkbox"/> 5305 MHz	<input type="checkbox"/> 5310 MHz	<input type="checkbox"/> 5315 MHz	<input type="checkbox"/> 5320 MHz	<input type="checkbox"/> 5325 MHz
<input type="checkbox"/> 5330 MHz	<input type="checkbox"/> 5335 MHz	<input type="checkbox"/> 5340 MHz	<input type="checkbox"/> 5345 MHz	<input type="checkbox"/> 5350 MHz	<input type="checkbox"/> 5355 MHz	<input type="checkbox"/> 5360 MHz	<input type="checkbox"/> 5365 MHz
<input type="checkbox"/> 5370 MHz	<input type="checkbox"/> 5375 MHz	<input type="checkbox"/> 5380 MHz	<input type="checkbox"/> 5385 MHz	<input type="checkbox"/> 5390 MHz	<input type="checkbox"/> 5395 MHz	<input type="checkbox"/> 5400 MHz	<input type="checkbox"/> 5405 MHz
<input type="checkbox"/> 5410 MHz	<input type="checkbox"/> 5415 MHz	<input type="checkbox"/> 5420 MHz	<input type="checkbox"/> 5425 MHz	<input type="checkbox"/> 5430 MHz	<input type="checkbox"/> 5435 MHz	<input type="checkbox"/> 5440 MHz	<input type="checkbox"/> 5445 MHz
<input type="checkbox"/> 5450 MHz	<input type="checkbox"/> 5455 MHz	<input type="checkbox"/> 5460 MHz	<input type="checkbox"/> 5465 MHz	<input type="checkbox"/> 5470 MHz	<input type="checkbox"/> 5475 MHz	<input type="checkbox"/> 5480 MHz	<input type="checkbox"/> 5485 MHz
<input type="checkbox"/> 5490 MHz	<input type="checkbox"/> 5495 MHz	<input type="checkbox"/> 5500 MHz	<input type="checkbox"/> 5505 MHz	<input type="checkbox"/> 5510 MHz	<input type="checkbox"/> 5515 MHz	<input type="checkbox"/> 5520 MHz	<input type="checkbox"/> 5525 MHz
<input type="checkbox"/> 5530 MHz	<input type="checkbox"/> 5535 MHz	<input type="checkbox"/> 5540 MHz	<input type="checkbox"/> 5545 MHz	<input type="checkbox"/> 5550 MHz	<input type="checkbox"/> 5555 MHz	<input type="checkbox"/> 5560 MHz	<input type="checkbox"/> 5565 MHz
<input type="checkbox"/> 5570 MHz	<input type="checkbox"/> 5575 MHz	<input type="checkbox"/> 5580 MHz	<input type="checkbox"/> 5585 MHz	<input type="checkbox"/> 5590 MHz	<input type="checkbox"/> 5595 MHz	<input type="checkbox"/> 5600 MHz	<input type="checkbox"/> 5605 MHz
<input type="checkbox"/> 5610 MHz	<input type="checkbox"/> 5615 MHz	<input type="checkbox"/> 5620 MHz	<input type="checkbox"/> 5625 MHz	<input type="checkbox"/> 5630 MHz	<input type="checkbox"/> 5635 MHz	<input type="checkbox"/> 5640 MHz	<input type="checkbox"/> 5645 MHz
<input type="checkbox"/> 5650 MHz	<input type="checkbox"/> 5655 MHz	<input type="checkbox"/> 5660 MHz	<input type="checkbox"/> 5665 MHz	<input type="checkbox"/> 5670 MHz	<input type="checkbox"/> 5675 MHz	<input type="checkbox"/> 5680 MHz	<input type="checkbox"/> 5685 MHz
<input type="checkbox"/> 5690 MHz	<input type="checkbox"/> 5695 MHz	<input checked="" type="checkbox"/> 5700 MHz	<input type="checkbox"/> 5705 MHz	<input type="checkbox"/> 5710 MHz	<input type="checkbox"/> 5715 MHz	<input type="checkbox"/> 5720 MHz	<input type="checkbox"/> 5725 MHz
<input type="checkbox"/> 5730 MHz	<input type="checkbox"/> 5735 MHz	<input type="checkbox"/> 5740 MHz	<input type="checkbox"/> 5745 MHz	<input type="checkbox"/> 5750 MHz	<input type="checkbox"/> 5755 MHz	<input type="checkbox"/> 5760 MHz	<input type="checkbox"/> 5765 MHz
<input type="checkbox"/> 5770 MHz	<input type="checkbox"/> 5775 MHz	<input type="checkbox"/> 5780 MHz	<input type="checkbox"/> 5785 MHz	<input type="checkbox"/> 5790 MHz	<input type="checkbox"/> 5795 MHz	<input type="checkbox"/> 5800 MHz	<input type="checkbox"/> 5805 MHz
<input type="checkbox"/> 5810 MHz	<input type="checkbox"/> 5815 MHz	<input type="checkbox"/> 5820 MHz	<input type="checkbox"/> 5825 MHz	<input type="checkbox"/> 5830 MHz	<input type="checkbox"/> 5835 MHz	<input type="checkbox"/> 5840 MHz	<input type="checkbox"/> 5845 MHz
<input type="checkbox"/> 5850 MHz	<input type="checkbox"/> 5855 MHz						

**Power Control**

- Transmitter Output Power: 7 dBm (min: -24 | max: 30)
- Antenna Gain: 15 dB (min: 0 | max: 40)
- Network Entry RSSI Threshold: -90 dBm (min: -100 | max: -20)

**Scheduler**

- Distance to AP: 1 Miles (min: 1 | max: 32)

**Advanced**

- RTS Threshold: 2346 min: 1 | max: 2346

© 2014 Cambium Networks, All Rights Reserved | Version 3.1 | Support | Community Forum

**Table 117** SM Radio Configuration attributes (Standard WiFi mode)

Attribute	Meaning
<b>General</b>	
Radio Mode	This parameter controls the function of the device – All ePMP devices may be configured to operate as an <b>Access Point (AP)</b> , <b>Subscriber Module (SM)</b> or as a <b>Spectrum Analyzer</b> .
Driver Mode	This parameter controls the wireless mode of operation of the SM.  <b>TDD:</b> The SM is operating in the proprietary TDD mode and will only connect to another ePMP Access Point.  <b>Standard WiFi:</b> The SM is operating in the Standard 802.11n WiFi mode and will be able to connect to any Access Point operating in standard 802.11n WiFi mode.  <b>ePTP Slave:</b> The SM is operating as a Slave in point-to-point mode. The AP and the system do not support GPS Synchronization in this mode but are able to provide <b>significantly lower latency</b> than other modes. QoS (MIR and traffic priority) capability and Link Quality/Capacity indicators are not available in this mode.
Fallback Country	The SM automatically inherits the Country Code setting of the AP (except for US-locked devices).  <b>Fallback Country</b> is used by the SM if the AP does not provide a Country Code to the SM during registration and affect the radios in the following ways: <ul style="list-style-type: none"> <li>• Maximum transmit power limiting (based on radio transmitter power plus configured antenna gain)</li> <li>• DFS operation is enabled based on the configured country code, if applicable</li> <li>• Frequency selection is based on local regulatory limits</li> </ul>
Range Unit	The unit of measurement used for configuring <b>Distance to AP</b> .
<b>Preferred AP List</b>	
Preferred APs	The <b>Preferred AP List</b> is comprised of a list of up to 16 APs to which the SM sequentially attempts registration. For each AP configured, if authentication is required, enter a <b>Pre-shared Key</b> associated with the configured <b>AP SSID</b> .
<b>Subscriber Module Scanning</b>	

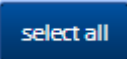
Attribute	Meaning
Scan Channel Bandwidth	<p>Click the  button to unselect all channel bandwidths. The SM will not scan for any frequencies.</p> <p>Click the  button to select all channel bandwidths. The SM will scan all channel bandwidths, i.e. 5 MHz, 10 MHz, 20 MHz and 40 MHz.</p> <p>Alternately choose individual channel bandwidth tabs and/or frequencies within each channel bandwidth tab for a customized scan list.</p>
Power Control	
Tx Power Manual Limit	<p><b>Auto:</b> The Access Point can control, using ATPC (Automatic Transmit Power Control), the TX power of the SM up to the maximum capability of the SM's transmitter (based on regulatory limits).</p> <p><b>Max Tx Output Power:</b> The Access Point can control the TX power of the SM up to the value configured in the <b>Transmitter Output Power</b> field below.</p>
Transmitter Output Power	The SM will not transmit higher than the configured value in the field. Determines the maximum output power of the transmitter. The actual output power may be lower due to Automatic Transmit Power Control (ATPC), where the AP instructs the SM to lower its power to meet the SM target Receive Level configured on the AP.
Antenna Gain	This value represents the amount of gain introduced by the unit's internal antenna. This parameter is read-only for Integrated radios.
Network Entry RSSI Threshold	Set this parameter to the minimum Received Signal Strength Indicator (RSSI) at the SM required for the SM to attempt registration to an AP. For example, if the <b>AP RSSI Threshold</b> is set to -80 dBm, and the SM is receiving the AP signal at -85 dBm (RSSI = -85 dBm), the SM will not attempt to register to the AP.
Scheduler	
Distance to AP	In Standard WiFi mode, this parameter represents cell coverage radius. SMs outside the configured radius will not achieve optimal throughput. It is recommended to configure <b>Distance to AP</b> to match the actual physical maximum range of the <b>farthest subscriber</b> . This must be configured to match the range of the farthest subscriber on <b>all</b> SMs under the AP regardless of their respective distance from the AP.
Advanced	
RTS Threshold	Configure the RTS packet size threshold for uplink data transmission. Range is between 0–2347 octets. Typically, sending RTS/CTS frames does not occur unless the packet size exceeds this threshold. If the packet size that the node wants to transmit is larger than the threshold, the RTS/CTS handshake gets triggered. Otherwise, the data frame gets sent immediately.



### SM Quality of Service page

The ePMP platform supports three QoS priority levels (not available in ePTP Master mode) using air fairness, priority-based starvation avoidance scheduling algorithm.

Ordering of traffic amongst the priority levels is based on a percentage of total link throughput. In other words, all priorities receive some throughput so that low priority traffic is not starved from transmission. In effect, the greatest amount of throughput is guaranteed to the VOIP priority level, then High, then Low.

Priority Level	ePMP Traffic Priority Label
Highest Priority	VOIP (only utilized when <b>VOIP Enable</b> is set to <b>Enabled</b> )
Medium Priority	High
Lowest Priority	Low

By default, all traffic passed over the air interface is low priority. The SM's Quality of Service page may be utilized to map traffic to certain priority levels using QoS classification rules. The rules included in the table are enforced starting with the first row of the table.



Caution

Each additional traffic classification rule increases device CPU utilization. Careful network traffic planning is required to efficiently use the device processor.

The ePMP platform also supports radio data rate limiting (Maximum Information Rate, or MIR) based on the configuration of the MIR table. Operators may add up to 16 MIR profiles on the AP, each with unique limits for uplink and downlink data rates. The SM field **MIR Profile Setting** is used to configure the appropriate MIR profile for limiting the SM's data rate.

Figure 69 SM Quality of Service page

Configuration > Quality of Service

Maximum Information Rate (MIR)

MIR Profile Number: 0

Traffic Priority

- Traffic Priority:  Disabled  Enabled
- VoIP Priority:  Disabled  Enabled
- Broadcast Priority:  Low  High
- Multicast Priority:  Low  High
- Subscriber Module Priority:  Normal  High  Low

QoS Classification Rules [Add](#) [Show Details](#)

Type	Details	Priority
CoS	5	Voice
DSCP	46	Voice

**Table 118** SM Quality of Service attributes

Attribute	Meaning
Maximum Information Rate (MIR)	
MIR Profile Number	Configure the desired MIR (Maximum Information Rate) profile for SM operation. This profile must be configured on the AP else the default profile (0) is used.
Traffic Priority	
Traffic Priority	<p><b>Enabled:</b> The QoS Classification Rules table is editable and is utilized by the device to classify traffic.</p> <p><b>Disabled:</b> The QoS Classification Rules table is greyed-out and all traffic is sent at one priority level.</p>
VoIP Priority	<p><b>Enabled:</b> When enabled, two entries are automatically added to the first and second rows of the QoS Classification Rules table, one with <b>Rule Type CoS</b> (5) and one with <b>Rule Type DSCP</b> (46). The addition of these rules ensures that VoIP traffic passed over the radio downlink is given highest priority. The <b>CoS</b> and <b>DSCP</b> values may be modified to accommodate non-standard VoIP equipment.</p>
Broadcast Priority	<p><b>Low Priority:</b> All Broadcast traffic sent over the uplink is prioritized as low priority and is delivered to the AP after scheduled high priority and VoIP traffic.</p> <p><b>High Priority:</b> All Broadcast traffic sent over the uplink is prioritized as high priority and is scheduled for delivery to the AP before low priority traffic but after VoIP traffic.</p>
Multicast Priority	<p><b>Low Priority:</b> All Multicast traffic sent over the uplink is prioritized as low priority and is delivered to the AP after scheduled high priority and VoIP traffic.</p> <p><b>High Priority:</b> All Multicast traffic sent over the uplink is prioritized as high priority and is scheduled for delivery to the AP before low priority traffic but after VoIP traffic.</p>
Subscriber Module Priority	<p><b>Normal:</b> SM gives priority to the packets as defined in the rules which could be "Low", "High", or "VoIP". "Normal" priority will allow data to be added to the appropriate "High", "Low", and "VoIP" queues based on the QoS rules. This is the default setting. If no rule is defined for a packet, then the packet priority will be "Low".</p> <p><b>High:</b> SM places all data other than VoIP in the "High" queue. It will be given higher priority than SMs configured with "Low" and "Normal" when there is contention for bandwidth under the AP.</p> <p><b>Low:</b> "Low" priority will place all data that is not VoIP in "Low" priority queue. It will be given lower priority than SMs configured with "High" when there is contention for bandwidth under the same AP.</p> <p>"VoIP" queue is the highest priority queue followed by "High" queue and then by "Low" queue. Higher priority queues have preference over lower priority queues, but will not starve them.</p>
QoS Classification Rules	The QoS Classification Rules table contains all of the rules enforced by the device when passing traffic over the radio downlink. Traffic passed through the device is matched against each rule in the table; when a match is made the traffic is sent over the radio link using the priority defined in column <b>Traffic Priority</b> .

Attribute	Meaning
Type	<p><b>DSCP:</b> Differentiated Services Code Point; traffic prioritization is based on the 6-bit Differentiated Services field in the IP header present in the packet entering the Ethernet port.</p> <p><b>CoS:</b> Class of Service; traffic prioritization is based on the 3-bit header present in the 802.1Q VLAN-tagged Ethernet frame header in the packet entering the SM's Ethernet port.</p> <p><b>VLAN ID:</b> Traffic prioritization is based on the VLAN ID of the packet entering the SM's Ethernet port.</p> <p><b>EtherType:</b> Traffic prioritization is based on 2 octet Ethertype field in the Ethernet frame entering the SM's Ethernet port. The Ethertype is used to identify the protocol of the data in the payload of the Ethernet frame.</p> <p><b>IP:</b> Traffic prioritization is based on the source and/or destination IP addresses of the packet entering the SM's Ethernet port. A subnet mask may be included to define a range of IP addresses to match.</p> <p><b>MAC:</b> Traffic prioritization is based on the source and/or destination MAC addresses of the packet entering the SM's Ethernet port. A mask may be included to define a range of MAC addresses to match. The mask is made up of a hex representation of a series of 1s to start the mask and 0s that end the mask. A 1 may not follow a 0. Thus, FF:FF:FF:FF:00:00 is allowed, but FF:00:FF:FF:FF:FF is not. The MAC address is combined with the mask to define the range of allowed MAC addresses.</p>
Details	<p>The <b>Rule Details</b> column is used to further configure each classification rule specified in column <b>Rule Type</b>.</p>
Priority	<p><b>High:</b> Traffic entering the SM's Ethernet port is prioritized as "high priority" for sending over the radio link (traffic will be sent after VOIP-classified traffic, but before Low-classified traffic).</p> <p><b>Low:</b> Traffic entering the SM's Ethernet port is prioritized as "low priority" for sending over the radio link (traffic will be sent after VOIP-classified and High-classified traffic is sent).</p>

### ***SM System page***

The SM's System page is used to configure system parameters, services, time settings, SNMP and syslog.

Figure 70 SM System page

Cambium Networks ePMP 1000 ePMP1000\_d026d7 Subscriber Module Administrator

### Configuration > System

**General**

Device Name: ePMP1000\_d026d7

Webpage Auto Update: 5 sec | min: 2 | max: 20

Web Access:  HTTP  HTTPS

HTTP Port: 80 min: 1 | max: 65535

SSH Access:  Disabled  Enabled

Telnet Access:  Disabled  Enabled

MAC-Telnet Access:  Disabled  Enabled

MAC-Telnet Protocol:  MAC-Telnet  MAC-SSH

**Network Time Protocol (NTP)**

IP Assignment:  Static  DHCP

Preferred NTP Server: [ ]

Alternate NTP Server: [ ]

Time Zone: UTC GMT - Greenwich Mean Time

**Location Services**

Device Latitude: 12.90 (degrees | min: -90 | max: 90)

Device Longitude: 77.28 (degrees | min: -180 | max: 180)

Device Height: [ ] (meters | min: -20000 | max: 20000)

Device Location: [Open in Google Maps](#)

**Simple Network Management Protocol (SNMP)**

Read-Only Community String: kreddum-123\_234

Read-Write Community String: kreddum-123\_234

System Name: kreddum

System Description: kreddum

Traps:  Disabled  Enabled

Trap Community String: kreddumtrap

Trap Servers: [Add](#) [Show Details](#)

Server IP	Server Port
Table is empty	

**System Logging (Syslog)**

Server 1: [ ]

Server 2: [ ]

Server 3: [ ]

Server 4: [ ]

Syslog Mask: [Unselect All](#) [Select All](#)

- Info  Notices
- Warnings  Errors
- Alerts  Emergency

**chMaestro**

Remote Management:  Disabled  Enabled

chMaestro URL: https://ge.cloud.cambiumnetworks.com

Cambium ID: [ ]

Onboarding Key: [ ]

**Account Management**

Administrator Account:  Disabled  Enabled

Username: admin

Password: [ ]

Home User Account:  Disabled  Enabled

Username: home

Password: [ ]

Installer Account:  Disabled  Enabled

Username: installer

Password: [ ]

Read Only Account:  Disabled  Enabled



Username: readonly

Password: [ ]

**Table 119** SM System attributes

Attribute	Meaning
General	
Device Name	The <b>Device Name</b> is used to identify the SM on the network, and may be retrieved by a NMS such as the Cambium Network Services Server (CNSS).
Webpage Auto Update	Configure the interval for which the device retrieves system statistics for display on the management interface. For example, if this setting is configured to 5 seconds, the statistics and status parameters displayed on the management interface will be refreshed every 5 seconds (default). <b>Webpage Auto Update is a session only configuration change. It is updated with the &lt;Enter&gt; key and is not savable when using the save button.</b>
Web Access	<b>HTTP:</b> Access to the device management GUI is conducted via HTTP. <b>HTTPS:</b> Access to the device management GUI is conducted via HTTPS.
HTTP Port	If <b>Web Service</b> is set to <b>HTTP</b> , configure the port which the device uses to service incoming HTTP requests for management GUI access.
HTTPS Port	If <b>Web Service</b> is set to <b>HTTPS</b> , configure the port which the device uses to service incoming HTTPS requests for management GUI access.
SSH Access	<b>Disabled:</b> If the SSH port to the device is 'Disabled', access to the device through SSH is not possible. <b>Enabled:</b> If the SSH port to the device is 'Enabled', Cambium engineers can access the device through SSH which enables them to login to the radio and troubleshoot. SSH port is 'Enabled' by default.
Telnet Access	<b>Disabled:</b> CLI access via telnet is not allowed for the device. <b>Enabled:</b> CLI access via telnet is allowed for the device.
MAC-Telnet Access	<b>Disabled:</b> Disables connections to the radio on the link layer via MAC address from RouterOS or mactelnet-enabled devices. <b>Enabled:</b> Enables connections to the radio on the link layer via MAC address from RouterOS or mactelnet-enabled devices.
	 <b>Note</b> In order to use MAC-Telnet the first time, the Administrator account password must be changed on the GUI or the CLI. This password can then be used for MAC-Telnet.
MAC-Telnet Protocol	<b>MAC-Telnet:</b> Use the MAC-Telnet subservice for access <b>MAC-SSH:</b> Use the secured MAC-SSH subservice for access
Network Time Protocol (NTP)	
IP Assignment	<b>Static:</b> The device retrieves NTP time data from the servers configured in fields <b>Preferred NTP Server and Alternate NTP Server</b> . <b>DHCP:</b> The device retrieves NTP time data from the server IP issued via a network DHCP server.

Attribute	Meaning
Preferred NTP Server	Configure primary NTP server IP address from which the device retrieves time and date information.
Alternate NTP Server	Configure secondary or alternate NTP server IP address from which the device retrieves time and date information.
Time Zone	The <b>Time Zone</b> option may be used to offset the received NTP time to match the operator's local time zone.
Location Services	
Device Latitude	Configure Latitude information for the device in decimal format.
Device Longitude	Configure Longitude information for the device in decimal format.
Device Height	Configure the Height above sea level for the device, in meters.
Device Location	Hyperlink to display the device location on Google Maps
Simple Network Management Protocol (SNMP)	
Read-Only Community String	Specify a community string that allows a Network Management Station (NMS) such as the Cambium Networks Services Server (CNSS) to read SNMP information. No spaces are allowed in this string. This password will never authenticate an SNMP user or an NMS to read/write access.  The <b>SNMP Read-only Community String</b> value is clear text and is readable by a packet monitor.
Read-Write Community String	Specify a community string that allows a Network Management Station (NMS) to not only read SNMP information but also write SNMP values that are defined as writeable in the radio. No spaces are allowed in this string.
System Name	Specify a string to associate with the physical module. This parameter can be polled by the Cambium Networks Services Server (CNSS) or an NMS. Special characters are supported.
System Description	Specify a description string to associate with the physical module. This parameter can be polled by the Cambium Networks Services Server (CNSS) or an NMS. Special characters are supported.
Traps	<b>Disabled:</b> With this setting, the radio does not send traps  <b>Enabled:</b> Setting this enables the radio to send SNMP traps to the configured SNMP Trap Server.
Trap Community String	Specify a control string to match the Trap Community String on the SNMP Trap server. No spaces are allowed in this string.
Trap Servers	The SNMP Trap Servers table contains all of the SNMP Trap servers the radio can send SNMP traps. Configure the IP Address which the device uses to send SNMP traps.
Server IP	Specify up to four SNMP Trap Servers to which the device will send SNMP traps.
Server Port	Configure port which the device uses to send SNMP traps.

Attribute	Meaning
System Logging (Syslog)	
Server 1-4	Specify up to four syslog servers to which the device sends syslog messages.
SysLog Mask	Configure the levels of syslog messages which the devices send to the servers configured in parameters <b>Syslog Server IP 1-4</b>
cnMaestro	
Remote Management	When <b>Enabled</b> , the device will be managed by cnMaestro - the Cambium Remote Management System, which allows all Cambium devices to be managed in the cloud.
cnMaestro URL	Configure the URL of cnMaestro. The default value is <a href="https://cloud.cambiumnetworks.com">https://cloud.cambiumnetworks.com</a> .
Cambium ID	Configure the Cambium ID that the device will use for on-boarding on to cnMaestro.
Onboarding key	Configure the password/key associated with the <b>Cambium-ID</b> that the device will use for on-boarding on to cnMaestro.
Account Management	
(Administrator) Username	Read-only listing of available login levels. <ul style="list-style-type: none"> <li>ADMINISTRATOR, full read write permissions.</li> <li>INSTALLER, permissions to read and write parameters applicable to unit installation and monitoring.</li> <li>HOME USER, permissions only to access pertinent information for support purposes.</li> <li>READONLY, permissions only to view the Monitor page.</li> </ul>
(Administrator) Password	Configure a custom password configuration for each user to secure the device. The password character display may be toggled using the visibility icon  .
Installer Account	<b>Disabled:</b> The disabled user is not granted access to the device management interface. The administrator user level cannot be disabled. <b>Enabled:</b> The user is granted access to the device management interface.
(Installer) Username	Read-only listing of available login levels: <ul style="list-style-type: none"> <li>INSTALLER, permissions to read and write parameters applicable to unit installation and monitoring.</li> <li>HOME USER, permissions only to access pertinent information for support purposes.</li> <li>READONLY, permissions only to view the Monitor page.</li> </ul>
(Installer) Password	Configure a custom password configuration for each user to secure the device. The password character display may be toggled using the visibility icon  .
Home User Account	<b>Disabled:</b> The disabled user is not granted access to the device management interface. The administrator user level cannot be disabled. <b>Enabled:</b> The user is granted access to the device management interface.

Attribute	Meaning
(Home) User Username	Read-only listing of available login levels: <ul style="list-style-type: none"><li>• HOME USER, permissions only to access pertinent information for support purposes.</li><li>• READONLY, permissions only to view the Monitor page.</li></ul>
(Home) User Password	Configure a custom password configuration for each user to secure the device. The password character display may be toggled using the visibility icon  .
Read-Only Account	<b>Disabled:</b> The disabled user is not granted access to the device management interface. The administrator user level cannot be disabled. <b>Enabled:</b> The user is granted access to the device management interface.
(Read-Only) Username	READONLY, permissions only to view the Monitor page.
(Read-Only) Password	Configure a custom password configuration for each user to secure the device.

### ***SM Network page***

The SM's **Network** page is used to configure system networking parameters and VLAN parameters. Parameter availability is based on the configuration of the **SM Network Mode** parameter.



Figure 71 SM Network page, NAT mode

The screenshot displays the 'Configuration > Network' page for a Cambium Networks device in NAT mode. The interface includes a left-hand navigation menu with options like Home, Quick Start, Configuration, Profile, Quality of Service, System, Network (selected), Security, Monitor, and Tools. The main content area is organized into several panels:

- General:** Contains settings for Internet Mode (WAN / Bridge / Router), Wireless IP Assignment (Static / DHCP), Wireless Subnet Mask (192.168.0.0), Wireless Gateway, Preferred DNS Server, Alternate DNS Server, Wireless IPv6 Assignment (Static / DHCPv6), Wireless IPv6 Address, Wireless IPv6 Gateway, Ethernet Port Security (Disabled / Enabled), Secure MAC Limit (0 / 100 / 200 / 254), and MAC Aging Time (300 / 600 / 900 / 1200 / 1500).
- Internet Interface:** Includes IP Address (192.1.1.254), Subnet Mask (255.255.255.0), IPv6 Address, DHCP Server (Disabled / Enabled), DHCP Server IP (192.1.1.1 / 192.168.1.1), DHCP End IP (192.1.1.10 / 192.168.1.254), Preferred DHCP DNS Server, Alternate DHCP DNS Server, and DHCP Lease Time (24 / 60 / 120 / 180 / 240).
- Separate Wireless Management Interface:** Features Separate Management IP (Disabled / Enabled), IP Assignment (Static / DHCP), IP Address, Subnet Mask, Gateway, IPv6 Assignment (Static / DHCPv6), IPv6 Address, IPv6 Gateway, Separate Management VLAN (Disabled / Enabled), VLAN ID (100 / 101 / 102 / 103 / 104 / 105 / 106 / 107 / 108 / 109 / 110 / 111 / 112 / 113 / 114 / 115 / 116 / 117 / 118 / 119 / 120 / 121 / 122 / 123 / 124 / 125 / 126 / 127 / 128 / 129 / 130 / 131 / 132 / 133 / 134 / 135 / 136 / 137 / 138 / 139 / 140 / 141 / 142 / 143 / 144 / 145 / 146 / 147 / 148 / 149 / 150 / 151 / 152 / 153 / 154 / 155 / 156 / 157 / 158 / 159 / 160 / 161 / 162 / 163 / 164 / 165 / 166 / 167 / 168 / 169 / 170 / 171 / 172 / 173 / 174 / 175 / 176 / 177 / 178 / 179 / 180 / 181 / 182 / 183 / 184 / 185 / 186 / 187 / 188 / 189 / 190 / 191 / 192 / 193 / 194 / 195 / 196 / 197 / 198 / 199 / 200), and VLAN Priority (100 / 101 / 102 / 103 / 104 / 105 / 106 / 107 / 108 / 109 / 110 / 111 / 112 / 113 / 114 / 115 / 116 / 117 / 118 / 119 / 120 / 121 / 122 / 123 / 124 / 125 / 126 / 127 / 128 / 129 / 130 / 131 / 132 / 133 / 134 / 135 / 136 / 137 / 138 / 139 / 140 / 141 / 142 / 143 / 144 / 145 / 146 / 147 / 148 / 149 / 150 / 151 / 152 / 153 / 154 / 155 / 156 / 157 / 158 / 159 / 160 / 161 / 162 / 163 / 164 / 165 / 166 / 167 / 168 / 169 / 170 / 171 / 172 / 173 / 174 / 175 / 176 / 177 / 178 / 179 / 180 / 181 / 182 / 183 / 184 / 185 / 186 / 187 / 188 / 189 / 190 / 191 / 192 / 193 / 194 / 195 / 196 / 197 / 198 / 199 / 200).
- Virtual Local Area Network (VLAN):** Shows VLAN Management (Static / Dynamic / Router), VLAN ID (100 / 101 / 102 / 103 / 104 / 105 / 106 / 107 / 108 / 109 / 110 / 111 / 112 / 113 / 114 / 115 / 116 / 117 / 118 / 119 / 120 / 121 / 122 / 123 / 124 / 125 / 126 / 127 / 128 / 129 / 130 / 131 / 132 / 133 / 134 / 135 / 136 / 137 / 138 / 139 / 140 / 141 / 142 / 143 / 144 / 145 / 146 / 147 / 148 / 149 / 150 / 151 / 152 / 153 / 154 / 155 / 156 / 157 / 158 / 159 / 160 / 161 / 162 / 163 / 164 / 165 / 166 / 167 / 168 / 169 / 170 / 171 / 172 / 173 / 174 / 175 / 176 / 177 / 178 / 179 / 180 / 181 / 182 / 183 / 184 / 185 / 186 / 187 / 188 / 189 / 190 / 191 / 192 / 193 / 194 / 195 / 196 / 197 / 198 / 199 / 200), and VLAN Priority (100 / 101 / 102 / 103 / 104 / 105 / 106 / 107 / 108 / 109 / 110 / 111 / 112 / 113 / 114 / 115 / 116 / 117 / 118 / 119 / 120 / 121 / 122 / 123 / 124 / 125 / 126 / 127 / 128 / 129 / 130 / 131 / 132 / 133 / 134 / 135 / 136 / 137 / 138 / 139 / 140 / 141 / 142 / 143 / 144 / 145 / 146 / 147 / 148 / 149 / 150 / 151 / 152 / 153 / 154 / 155 / 156 / 157 / 158 / 159 / 160 / 161 / 162 / 163 / 164 / 165 / 166 / 167 / 168 / 169 / 170 / 171 / 172 / 173 / 174 / 175 / 176 / 177 / 178 / 179 / 180 / 181 / 182 / 183 / 184 / 185 / 186 / 187 / 188 / 189 / 190 / 191 / 192 / 193 / 194 / 195 / 196 / 197 / 198 / 199 / 200).
- Internet Port:** Includes Internet MTU (1500 / 1024 / 512 / 256 / 128), Internet Port (Disabled / Enabled), Port Setting (Manual / Auto-Negotiate), Auxiliary Port (Disabled / Enabled), Auxiliary Port Setting (Manual / Auto-Negotiate), and Auxiliary Port PoE (Disabled / Enabled).
- Port Forwarding:** Shows DMZ (Disabled / Enabled), NAT PMP/PCPN (Disabled / Enabled), and Data Port Forwarding (Disabled / Enabled).
- Remote-Access Protocol over Ethernet (PPoE):** Contains IP Pool (Disabled / Enabled), Service Name (ppoe), Access Concentration (Ethernet), Authentication (ALL / PAP / CHAP), Username (admin), Password (\*\*\*\*), MTU Size (1462 / 1500 / 1550 / 1600 / 1650 / 1700 / 1750 / 1800 / 1850 / 1900 / 1950 / 2000), Keep-Alive Time (10 / 15 / 20 / 25 / 30 / 35 / 40 / 45 / 50 / 55 / 60 / 65 / 70 / 75 / 80 / 85 / 90 / 95 / 100 / 105 / 110 / 115 / 120 / 125 / 130 / 135 / 140 / 145 / 150 / 155 / 160 / 165 / 170 / 175 / 180 / 185 / 190 / 195 / 200), and MS Charging (Disabled / Enabled).
- 802.1Q VLAN Edge (QVLAN):** Includes 802.1Q (Disabled / Enabled), QVLAN (Disabled / Enabled), P Address, and Advanced settings like IPv6 Support (Disabled / Enabled), Spanning Tree Protocol (Disabled / Enabled), DHCP Server Snooping (Disabled / Enabled), STP Helper for IGMP (Disabled / Enabled), IGMP (Disabled / Enabled), and IGMP Mode (Normal and Normal / Receive only).

**Table 120** SM Network attributes, NAT mode

Attribute	Meaning
General	
<b>Network Mode</b>	<p><b>NAT:</b> The SM acts as a router and packets are forwarded or filtered based on their IP header (source or destination).</p> <p><b>Bridge:</b> The SM acts as a switch and packets are forwarded or filtered based on their MAC destination address.</p> <p><b>Router:</b> The SM acts as a router and packets are forwarded or filtered based on their IP header (source or destination) using specific static routes and IP aliases configured by the operator.</p>
<b>Wireless IP Assignment</b>	<p>Static: <b>Wireless IP addressing is configured manually in fields</b> Wireless IP Address, Wireless IP Subnet Mask, Wireless Gateway IP Address, Preferred DNS IP Address <b>and</b> Alternate DNS IP Address.</p> <p>DHCP: <b>Device management IP addressing (IP address, subnet mask, gateway and DNS server) is assigned via a network DHCP server.</b></p>
<b>Wireless IP Address</b>	<b>Wireless Internet protocol (IP) address. This address is used by the family of Internet protocols to uniquely identify this unit on a network.</b>
<b>Wireless Subnet Mask</b>	<b>Defines the address range of the connected IP network. For example, if Wireless IP Address is configured to 192.168.2.1 and Wireless IP Subnet Mask is configured to 255.255.255.0, the device wireless interface will belong to subnet 192.168.2.X.</b>
<b>Wireless Gateway</b>	<b>Configure the IP address of a computer on the current network that acts as a gateway. A gateway acts as an entrance and exit to packets from and to other networks.</b>
<b>Preferred DNS Server</b>	<b>Configure The IP address of the preferred server used for DNS resolution.</b>
<b>Alternate DNS Server</b>	<b>Configure The IP address of the alternate server used for DNS resolution.</b>
<b>Wireless IPv6 Assignment</b>	<p>Wireless IPv6 Assignment <b>specifies how the IPv6 address for the wireless interface is obtained.</b></p> <p>Static: <b>Device management IP addressing is configured manually in fields</b> Wireless IPv6 Address <b>and</b> Wireless IPv6 Gateway.</p> <p>DHCPv6: <b>Device management IP addressing (IP address and gateway) is assigned via a network DHCP server, and parameters</b> Wireless IPv6 Address <b>and</b> Wireless IPv6 Gateway <b>are unused. If the DHCPv6 server is not available previous static IPv6 address will be used as a fallback IPv6 address. If no previous static IPv6 address is available, no IPv6 address will be assigned. DHCPv6 will occur over the wireless interface by default.</b></p>

Attribute	Meaning
Wireless IPv6 Address	<p>Internet protocol version 6 (IPv6) address. This address is used by the family of Internet protocols to uniquely identify this unit (wireless interface) on a network.</p> <p>IPv6 addresses are represented by eight groups of four hexadecimal digits separated by colons.</p>
Wireless IPv6 Gateway	<p>Configure the IPv6 address of the device on the current network that acts as a gateway. A gateway acts as an entrance and exit to packets from and to other networks.</p>
Ethernet Port Security	<p>Disabled: When disabled, any number of devices (MAC Addresses) can connect via the SM's Ethernet (LAN) port.</p> <p>Enabled: When enabled, the number of devices (MAC Addresses) that can connect via the SM's Ethernet (LAN) port can be restricted with the fields below.</p>
Secure MAC Limit	<p>Specify the maximum number of unique devices (MAC Addresses) that can connect via the SM's Ethernet (LAN) port. Range is 1 – 254 devices.</p>
MAC Aging Time	<p>Specify the aging timer in seconds. The aging timer will determine the duration for which the SM will maintain the MAC Address in its bridge table. The timer is restarted any time traffic from a specific MAC address is received on the LAN port. Once the timer expires, the MAC Address is removed from the SM's bridge table.</p>
Ethernet Interface	
IP Address	<p>Internet protocol (IP) address. This address is used by the family of Internet protocols to uniquely identify this unit on a network.</p>
Subnet Mask	<p>Defines the address range of the connected IP network. For example, if Device IP Address (LAN) is configured to 192.168.2.1 and IP Subnet Mask (LAN) is configured to 255.255.255.0, the device will belong to subnet 192.168.2.X.</p>
IPv6 Address	<p>Internet protocol version 6 (IPv6) address. This address is used by the family of Internet protocols to uniquely identify this unit (Ethernet interface) on a network.</p> <p>IPv6 addresses are represented by eight groups of four hexadecimal digits separated by colons.</p>
Gateway	<p>Configure the IP address of a computer on the current network that acts as a gateway. A gateway acts as an entrance and exit to packets from and to other networks.</p>
DHCP Server	<p>Disabled: Use this setting when SM is in NAT mode, if there is an existing DHCP Server below the SM handing out IP Addresses or if all devices below the SM will be configured with static IP Addresses.</p> <p>Enabled: Use this setting when SM is in NAT mode, to use the SM's local/onboard DHCP server to hand out IP addresses to its clients.</p>

Attribute	Meaning
DHCP Start IP	Configure the first address which will be issued to a DHCP client. Upon additional DHCP requests, the DHCP Start IP is incremented until Local DHCP End IP is reached.
DHCP End IP	Configure the highest IP address in the DHCP pool that can be issued to a DHCP client.
Preferred DHCP DNS Server	Configure the primary DNS Server IP address which will be used to configure DHCP clients (if Local DHCP Server is set to Enabled).
Alternate DHCP DNS Server	Configure the secondary DNS Server IP address which will be used to configure DHCP clients (if Local DHCP Server is set to Enabled).
DHCP Lease Time	Configure the time for which a DHCP IP address is leased. When the lease time expires, the DHCP client must renew IP addressing via DHCP request.
DHCP Clients	The DHCP Client List table identifies hardware situated below the SM which shall be issued DHCP IP addressing information. The SM acts as a DHCP server, responding to requests from hardware connected to the SM.
MAC	Configure the physical address of the device which will retrieve DHCP IP addressing information from the SM.
IP	Configure the IP address which will be assigned to the device.
Name	Configure a logical name for the device configured (i.e. VoIP Phone1, or Network Camera1).
Separate Wireless Management Interface	
Separate Management IP	Disabled: When disabled, the Wireless IP is the management interface for the SM. Enabled: When enabled, the IP Address below is the management interface for the SM.
IP Assignment	Static: Separate Wireless Management Interface is configured manually in fields IP Address, Subnet Mask and Gateway. DHCP: Management IP addressing (IP address, subnet mask, gateway and DNS server) is assigned via a network DHCP server.
IP Address	Configure the IP address that will be used to access the SM's management interface when in NAT mode. The Wireless IP (public IP) will not allow management access.
Subnet Mask	Defines the address range of the connected IP network. For example, if IP Address is configured to 192.168.2.1 and Subnet Mask is configured to 255.255.255.0, the device wireless interface will belong to subnet 192.168.2.X.
Gateway	Configure the IP address of a computer on the current network that acts as a gateway. A gateway acts as an entrance and exit to packets from and to other networks.

Attribute	Meaning
<b>IPv6 Assignment</b>	<p>IPv6 Assignment <b>specifies how the IPv6 address for the separate wireless interface is obtained.</b></p> <p>Static: <b>Device management IP addressing is configured manually in fields IPv6 Address and IPv6 Gateway.</b></p> <p>DHCPv6: <b>Device management IP addressing (IP address and gateway) is assigned via a network DHCP server, and parameters IPv6 Address and IPv6 Gateway are unused. If the DHCPv6 server is not available previous static IPv6 address will be used as a fallback IPv6 address. If no previous static IPv6 address is available, no IPv6 address will be assigned. DHCPv6 will occur over the wireless interface by default.</b></p>
<b>IPv6 Address</b>	<p><b>Internet protocol version 6 (IPv6) address. This address is used by the family of Internet protocols to uniquely identify this unit (separate wireless interface) on a network.</b></p> <p><b>IPv6 addresses are represented by eight groups of four hexadecimal digits separated by colons.</b></p>
<b>IPv6 Gateway</b>	<p><b>Configure the IPv6 address of the device on the current network that acts as a gateway. A gateway acts as an entrance and exit to packets from and to other networks.</b></p>
<b>Separate Management VLAN</b>	<p>Enabled: <b>A VLAN configuration establishes a logical group within the network. Each computer in the VLAN, regardless of initial or eventual physical location, has access to the same data based on the VLAN architecture. For the network operator, this provides flexibility in network segmentation, simpler management and enhanced security. When the SM is in NAT mode, the Separate Wireless Management VLAN configuration is applicable to management data.</b></p> <p>Disabled: <b>When disabled, the SM does not have a unique management VLAN.</b></p>
<b>VLAN ID</b>	<p><b>Configure this parameter to include the device's management traffic on a separate VLAN network.</b></p>
<b>VLAN Priority</b>	<p>ePMP radios can prioritize VLAN traffic based on the eight priorities described in the IEEE 802.1p specification. <b>Data VLAN Priority</b> represents the VLAN Priority or Class of Service (CoS). Operators may use this prioritization field to give precedence to device management data.</p> <p><b>This parameter only takes effect if the Separate Wireless Management VLAN parameter is enabled. Configure this parameter to set the value of the Priority code point field in the 802.1q tag for management traffic on the configured VLAN ID originating from the SM. The default value is 0.</b></p>
Virtual Local Area Management (VLAN)	

Attribute	Meaning
<b>VLAN (Management + Data)</b>	<p>Enabled: <b>A VLAN configuration establishes a logical group within the network. Each computer in the VLAN, regardless of initial or eventual physical location, has access to the same data based on the VLAN architecture. For the network operator, this provides flexibility in network segmentation, simpler management and enhanced security. When the SM is in NAT or Router mode, the VLAN configuration is applicable to both management and user data.</b></p> <p>Disabled: <b>When disabled, all IP management and data traffic is allowed to the device.</b></p>
<b>VLAN ID</b>	<b>Configure this parameter to include the device's management and user traffic on a separate VLAN network.</b>
<b>VLAN Priority</b>	<p>ePMP radios can prioritize VLAN traffic based on the eight priorities described in the IEEE 802.1p specification. <b>Data VLAN Priority</b> represents the VLAN Priority or Class of Service (CoS). Operators may use this prioritization field to give precedence to device user and management data.</p> <p>This parameter only takes effect if the <b>VLAN</b> parameter is enabled. Configure this parameter to set the value of the Priority code point field in the 802.1q tag for traffic on the configured VLAN ID originating from the <b>SM</b>. The default value is 0.</p>
Ethernet Port	
<b>Ethernet MTU</b>	Maximum Transmission Unit; the size in bytes of the largest data unit that the device is configured to process. Larger MTU configurations can enable the network to operate with greater efficiency, but in the case of retransmissions due to packet errors, efficiency is reduced since large packets must be resent in the event of an error.
<b>Ethernet Port</b>	<p><b>Disabled:</b> The primary Ethernet port is disabled</p> <p><b>Enabled:</b> The primary Ethernet port is enabled</p>
<b>Port Setting</b>	<p>Manual: <b>The LAN Ethernet port speed and duplex mode can be manually configured.</b></p> <p><b>Auto-negotiate:</b> The AP auto negotiates the LAN Ethernet port speed and duplex mode with the device connected to it.</p>
<b>Port Speed</b>	With "Ethernet Port Configuration" set to Manual, the LAN Ethernet port speed can be forced to 1000 Mbps (only GPS Synchronized radio), 100 Mbps or 10 Mbps.
<b>Port Duplex Mode</b>	With "Ethernet Port Configuration" set to Manual, the LAN Ethernet port duplex mode can be forced to Full or Half.
<b>Auxiliary Port</b>	<p>Disabled: <b>When disabled, the LAN Auxiliary port on the SM is shut down.</b></p> <p>Enabled: When enabled, LAN Auxiliary port on the SM is up and able to bridge traffic with the primary Ethernet port. Default value is Enabled.</p>
<b>Auxiliary Port Setting</b>	<p>Manual: <b>The LAN Auxiliary port speed and duplex mode can be manually configured.</b></p> <p><b>Auto-negotiate:</b> The AP auto negotiates the LAN Auxiliary port speed and duplex mode with the device connected to it.</p>

Attribute	Meaning
<b>Auxiliary Port Speed</b>	With “Auxiliary Port Configuration” set to Manual, the LAN Auxiliary port speed can be forced to 1000 Mbps (only GPS Synchronized radio), 100 Mbps or 10 Mbps.
<b>Auxiliary Port Duplex Mode</b>	With “Auxiliary Port Configuration” set to Manual, the LAN Auxiliary port duplex mode can be forced to Full or Half.
<b>Auxiliary Port PoE</b>	<p><b>Disabled:</b> When disabled, the LAN Auxiliary port on the SM will not provide proprietary PoE out. Default value is Disabled.</p> <p><b>Enabled:</b> When enabled, LAN Auxiliary port on the SM will provide proprietary PoE out to power external PoE devices such as another ePMP radio or a PoE camera.</p>
Port Forwarding	
<b>Port Forwarding</b>	<p><b>The SM port forwarding functionality may be used to configure the SM to route external network services to an internal IP address so that end devices (situated below the SM) are reachable from external networks.</b></p> <hr/> <p> Caution</p> <p>Opening ports for forwarding may introduce a network security risk.</p>
<b>UPnP IGD</b>	<p>Universal Plug and Play (UPnP) is a set of networking protocols that permits networked devices, such as personal computers, printers, Internet gateways, Wi-Fi access points and mobile devices to seamlessly discover each other's presence on the network and establish functional network services for data sharing, communications, and entertainment. UPnP is intended primarily for residential networks without enterprise-class devices. With UPnP IGD and PCP protocols ePMP will support explicit dynamic port mappings.</p> <p>Enable UPnP IGD (Internet Gateway Device) to allow the ePMP device to use IGD profile for UPnP support.</p>
<b>NAT PMP (PCP)</b>	<p>The PCP (Port Control Protocol) allows an IPv6 or IPv4 host to control how incoming IPv6 or IPv4 packets are translated and forwarded by a Network Address Translator (NAT) or simple firewall, and also allows a host to optimize its outgoing NAT keepalive messages. PCP was standardized as a successor to the NAT Port Mapping Protocol (NAT-PMP), with which it shares similar protocol concepts and packet formats.</p> <p>Enable this parameter to allow the ePMP device to use PCP protocol for UPnP support.</p>
<b>Data Port Forwarding</b>	<b>The Data Port Forwarding Table is used to define which range of wireless ports that are forwarded to a LAN (SM local network) IP address below the SM.</b>
<b>Protocol</b>	<p>UDP: Packet forwarding decisions are based on UDP packets.</p> <p>TCP: Packet forwarding decisions are based on TCP packets.</p>
<b>Port Begin</b>	<b>Configure the beginning of the range of wireless ports to match for forwarding to LAN IP.</b>

Attribute	Meaning
<b>Port End</b>	<b>Configure the end of the range of wireless ports to match for forwarding to LAN IP.</b>
<b>Forwarding IP</b>	<b>Configure the LAN IP of the device situated below the SM which receives the packets forwarded based on the Separate Management IP Port Forwarding Table configuration.</b>
<b>Mapped Port</b>	<b>Configure the port of the device situated below the SM which receives the packets forwarded based on the Data Port Forwarding Table configuration.</b>
<b>Separate Management IP Port Forwarding</b>	<b>The Separate Management IP Port Forwarding Table is used to define which range of wireless ports from which Management traffic on the Separate Management IP is forwarded to a LAN (SM local network) IP address below the SM.</b>
<b>Protocol</b>	UDP: Packet forwarding decisions are based on UDP packets. TCP: Packet forwarding decisions are based on TCP packets.
<b>Port Begin</b>	<b>Configure the beginning of the range of wireless ports to match for forwarding to LAN IP.</b>
<b>Port End</b>	<b>Configure the end of the range of wireless ports to match for forwarding to LAN IP.</b>
<b>Forwarding IP</b>	<b>Configure the LAN IP of the device situated below the SM which receives the packets forwarded based on the Separate Management IP Port Forwarding Table configuration.</b>
<b>Mapped Port</b>	<b>Configure the port of the device situated below the SM which receives the packets forwarded based on the Separate Management IP Port Forwarding Table configuration.</b>
Point-to-Point Protocol over Ethernet (PPPoE)	
<b>PPPoE</b>	Point-to-Point Protocol over Ethernet: <b>Used for Encapsulating PPP frames inside Ethernet frames.</b>
<b>Service Name</b>	<b>An optional entry to set a specific service name to connect to for the PPPoE session. If this is left blank the SM accepts the first service option that comes back from the Access Concentrator specified below, if any. This is limited to 32 characters.</b>
<b>Access Concentrator</b>	<b>An optional entry to set a specific Access Concentrator to connect to for the PPPoE session. If this is blank, the SM accepts the first Access Concentrator which matches the service name (if specified). This is limited to 32 characters.</b>
<b>Authentication</b>	ALL: This means that CHAP authentication will be attempted first, then PAP authentication. The same password is used for both types. CHAP: This means that CHAP authentication will be attempted. PAP: This means that PAP authentication will be attempted.
<b>Username</b>	<b>This is the CHAP/PAP username that is used. This is limited to 32 characters.</b>



Attribute	Meaning
<b>Password</b>	This is the CHAP/PAP password that is used. This is limited to 32 characters.
<b>MTU Size</b>	<b>Maximum Transmission Unit; the size in bytes of the largest data unit that the device is configured to process inside the PPPoE tunnel. This field allows the operator to specify the largest MTU value to use in the PPPoE session, if PPPoE MSS Clamping is Enabled. The user will be able to enter an MTU value up to 1492. However, if the MTU determined in LCP negotiations is less than this user-specified value, the SM uses the smaller value as its MTU for the PPPoE link.</b>
<b>Keep Alive Time</b>	<b>Configure the Keep Alive Time to allow the radio to keep the PPPoE session up after establishment. As an example, if this field is set to 5, the PPPoE client will send a keep alive message to the PPPoE server every 5 seconds. If there is no acknowledgement, it sends the 'Keep alive' message to the server 4 more times (for a total of 5 times) before tearing down the PPPoE session. Setting this to 12 will mean the keep alive message will be sent every 12 seconds and when there is no acknowledgement, the client will try for a total of 12 times every 12 seconds before tearing down the PPPoE session.</b>
<b>MSS Clamping</b>	<p>Disabled: The SM PPPoE session allows any MTU size determined by other devices in the PPPoE session during the LCP negotiations.</p> <p>Enabled: The SM PPPoE session enforces a max MTU size determined by the PPPoE MTU Size setting for all devices in the PPPoE session during the LCP negotiations, unless one of the devices enforces a MTU setting that is smaller in value.</p>
De-Militarized Zone (DMZ)	
<b>DMZ</b>	<p>Disabled: Packets arriving on the Wireless Interface destined for the Ethernet side of the network are dropped if a session does not exist between the Source IP (Wireless) and Destination IP (Ethernet). By default NAT requires the sessions to be initiated from the Ethernet side before a packet is accepted from the Wireless to the Wired side."</p> <p>Enabled: Any packets with an unknown destination port (not associated to an existing session or not defined in the port forwarding rules) is automatically sent to the device configured with DMZ IP Address."</p>
<b>IP Address</b>	<b>Configure the IP address of an SM connected device which is allowed to provide network services to the wide-area network.</b>
Advanced	
<b>IPv6 Support</b>	<b>Systemwide IPv6 Protocol Support. When enabled, appropriate IPv6 modules and services will be loaded.</b>

Attribute	Meaning
ARP-NAT	<p>ARP-NAT or Wireless Client Bridging is a special MAC address translation mechanism. It is similar to NAT for IP networks, except it works one layer deeper. Instead of translating IP network addresses, the ePMP device translates between the MAC hardware addresses on both sides of the interface. If a device on the wired side of the router makes an ARP request for the MAC address of an IP on the wireless side, then the ePMP device forwards the request as if it came from the ePMP device. When the response comes back, it translates the address again. Instead of passing back the real MAC (which resides on the wireless network), the ePMP device gives its own wired MAC address. Then, when it receives frames for IP addresses on the wireless network, it forwards them through (conducted on both sides of the bridge).</p> <p>ARP-NAT is configured on the SM in section Configuration &gt; Network &gt; Advanced.</p>
<div style="background-color: #f0f0f0; padding: 10px; border: 1px solid #ccc;">  <b>Note</b>            PPPoE Client on PCs connected to the SM is not supported and throughput decreases when ARP-NAT feature is enabled.         </div>	
Spanning Tree Protocol	<p>Disabled: <b>When disabled, Spanning Tree Protocol (802.1d) functionality is disabled at the SM.</b></p> <p>Enabled: <b>When enabled, Spanning Tree Protocol (802.1d) functionality is enabled at the SM, allowing for the prevention of Ethernet bridge loops.</b></p>
DHCP Server Below SM	<p>Disabled: <b>This blocks DHCP servers connected to the SM's LAN side from handing out IP addresses to DHCP clients above the SM (wireless side).</b></p> <p>Enabled: <b>This allows DHCP servers connected to the SM's LAN side to assign IP addresses to DHCP clients above the SM (wireless side). This configuration is typical in PTP links.</b></p>
NAT Helper For SIP	<p>Disabled: <b>When disabled, the SM does not perform any deep packet manipulation on the SIP request packet from a SIP Client.</b></p> <p>Enabled: <b>When enabled, the SM in NAT mode replaces the Source IP within the SIP request to the Wireless IP of the SM. Please note that this translation is often times handled by the SIP server so this option may not always be needed.</b></p>
LLDP	<p>The Link Layer Discovery Protocol (LLDP) is a vendor-neutral link layer protocol (as specified in IEEE 802.1AB) used by ePMP for advertising its identity, capabilities, and neighbors on the Ethernet/wired interface.</p> <p><b>Disabled:</b> ePMP does not Receive or Transmit LLDP packets from/to its neighbors.</p> <p><b>Enabled:</b> ePMP can Receive LLDP packets from its neighbors and Send LLDP packets to its neighbors, depending on the <b>LLDP Mode</b> configuration below.</p>

---

Attribute	Meaning
<b>LLDP Mode</b>	<b>Receive and Transmit:</b> ePMP sends and receives LLDP packets to/from its neighbors on the Ethernet/LAN interface. <b>Receive Only:</b> ePMP receives LLDP packets from its neighbors on the Ethernet/LAN interface and discovers them.

---

Figure 72 SM Network page, Bridge mode

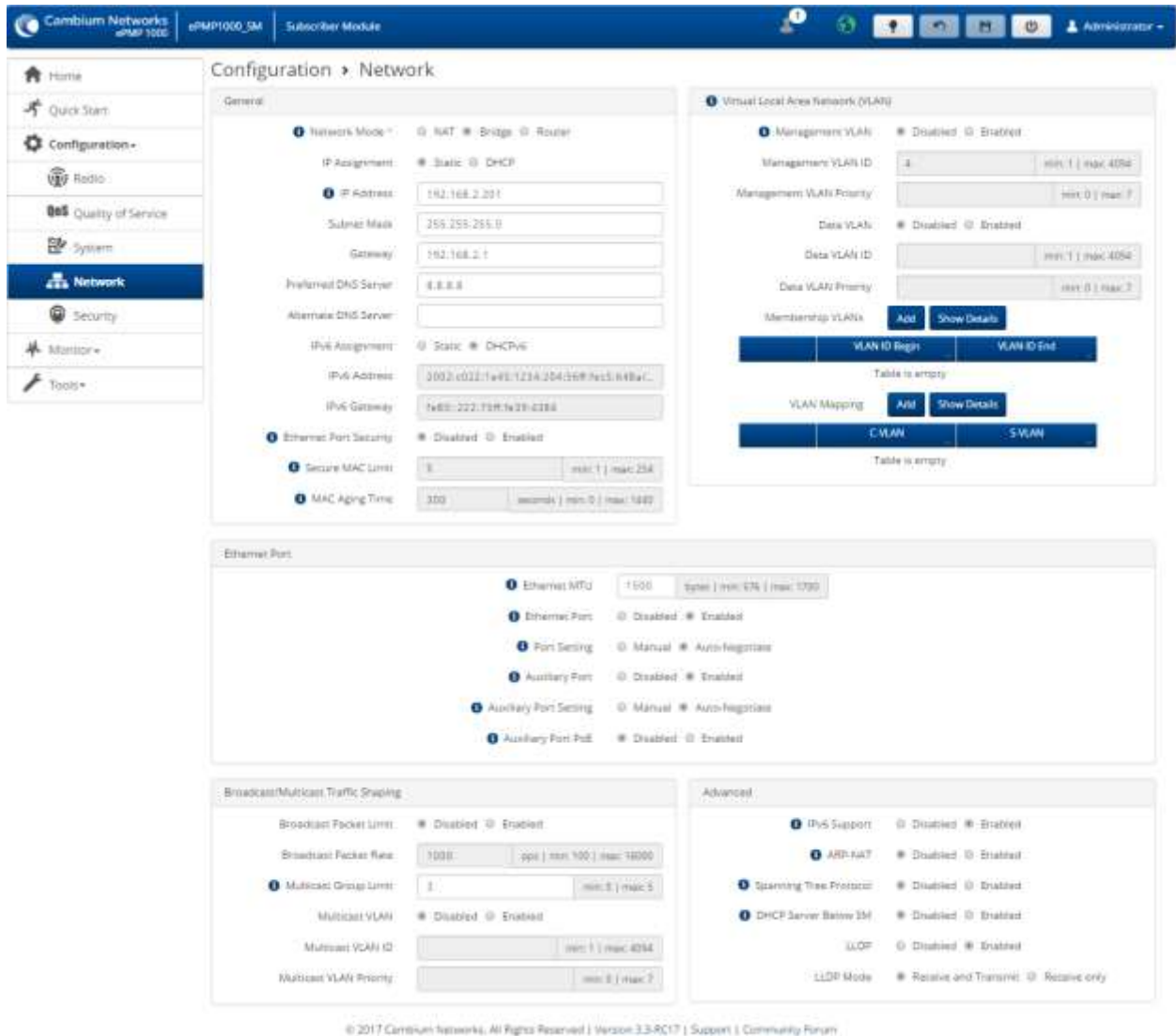





Table 121 SM Network attributes, Bridge mode

Attribute	Meaning
General	
<b>Network Mode</b>	<p><b>NAT:</b> The SM acts as a router and packets are forwarded or filtered based on their IP header (source or destination).</p> <p><b>Bridge:</b> The SM acts as a switch and packets are forwarded or filtered based on their MAC destination address.</p> <p><b>Router:</b> The SM acts as a router and packets are forwarded or filtered based on their IP header (source or destination) using specific static routes and IP aliases configured by the operator.</p>

Attribute	Meaning
<b>IP Assignment</b>	<p>Static: <b>Device management IP addressing is configured manually in fields IP Address, Subnet Mask, Gateway, Preferred DNS Server and Alternate DNS Server.</b></p> <p>DHCP: <b>Device management IP addressing (IP address, subnet mask, gateway, and DNS server) is assigned via a network DHCP server, and parameters IP Address, Subnet Mask, Gateway, Preferred DNS Server and Alternate DNS Server are unused.</b></p>
<b>IP Address</b>	<p><b>Internet protocol (IP) address. This address is used by the family of Internet protocols to uniquely identify this unit on a network.</b></p> <div style="background-color: #f0f0f0; padding: 5px;"> <p> <b>Note</b></p> <p>If Device IP address Mode is set to DHCP and the device is unable to retrieve IP address information via DHCP, the device management IP is set to fall back to IP 192.168.0.1 (AP mode), 192.168.0.2 (SM mode), 192.168.0.3 (Spectrum Analyzer mode) or the previously-configured static Device IP Address. Units may always be accessed via the Ethernet port with IP 169.254.1.1. 169.254.1.1 is a local IP and is independent of the NAT local subnet or the wireless IP.</p> </div>
<b>Subnet Mask</b>	<p><b>Defines the address range of the connected IP network. For example, if IP Address, Subnet Mask, Gateway, Preferred DNS Server and Alternate DNS Server are configured to 255.255.255.0, the device will belong to subnet 192.168.2.X.</b></p>
<b>Gateway</b>	<p><b>Configure the IP address of a computer on the current network that acts as a gateway. A gateway acts as an entrance and exit to packets from and to other networks.</b></p>
<b>Preferred DNS Server</b>	<p><b>Configure the IP address of the preferred server used for DNS resolution.</b></p>
<b>Alternate DNS Server</b>	<p><b>Configure the IP address of the alternate server used for DNS resolution.</b></p>
<b>IPv6 Assignment</b>	<p>IPv6 Assignment <b>specifies how the IPv6 address is obtained.</b></p> <p>Static: <b>Device management IP addressing is configured manually in fields IPv6 Address and IPv6 Gateway.</b></p> <p>DHCPv6: <b>Device management IP addressing (IP address and gateway) is assigned via a network DHCP server, and parameters IPv6 Address and IPv6 Gateway are unused. If the DHCPv6 server is not available previous static IPv6 address will be used as a fallback IPv6 address. If no previous static IPv6 address is available, no IPv6 address will be assigned. DHCPv6 will occur over the wireless interface by default.</b></p>
<b>IPv6 Address</b>	<p><b>Internet protocol version 6 (IPv6) address. This address is used by the family of Internet protocols to uniquely identify this unit on a network.</b></p> <p><b>IPv6 addresses are represented by eight groups of four hexadecimal digits separated by colons.</b></p>
<b>IPv6 Gateway</b>	<p><b>Configure the IPv6 address of the device on the current network that acts as a gateway. A gateway acts as an entrance and exit to packets from and to other networks.</b></p>

Attribute	Meaning
<b>Ethernet Port Security</b>	<p>Disabled: <b>When disabled, any number of devices (MAC Addresses) can connect via the SM's Ethernet (LAN) port.</b></p> <p>Enabled: <b>When enabled, the number of devices (MAC Addresses) that can connect via the SM's Ethernet (LAN) port can be restricted with the fields below.</b></p>
<b>Secure MAC Limit</b>	<b>Specify the maximum number of unique devices (MAC Addresses) that can connect via the SM's Ethernet (LAN) port. Range is 1 – 254 devices.</b>
<b>MAC Aging Time</b>	<b>Specify the aging timer in seconds. The aging timer will determine the duration for which the SM will maintain the MAC Address in its bridge table. The timer is restarted any time traffic from a specific MAC address is received on the LAN port. Once the timer expires, the MAC Address is removed from the SM's bridge table.</b>
Virtual Local Area Network (VLAN)	
<b>Management VLAN</b>	<p>Enabled: <b>The SM management interface can be assigned to a Management VLAN to separate management traffic (remote module management via SNMP or HTTP) from user traffic (such as internet browsing, voice, or video). Once the management interface is enabled for a VLAN, an SM's management interface can be accessed only by packets tagged with a VLAN ID matching the management VLAN ID.</b></p> <p>A VLAN configuration establishes a logical group within the network. For the network operator, this provides flexibility in network segmentation, simpler management and enhanced security.</p> <p>Disabled: <b>When disabled, all untagged IP management traffic is allowed to the device.</b></p>
<b>Management VLAN ID</b>	<b>Configure this parameter to include the device's management traffic on a separate VLAN network. For example, if MGMT VLAN ID is set to 2, GUI access will only be allowed from frames tagged with VLAN ID 2. This parameter only takes effect if the MGMT VLAN parameter is enabled.</b>
<b>Management VLAN Priority</b>	<p>ePMP radios can prioritize VLAN traffic based on the eight priorities described in the IEEE 802.1p specification. <b>MGMT VLAN Priority</b> represents the VLAN Priority or Class of Service (CoS). Operators may use this prioritization field to give precedence to device management traffic.</p> <p>This parameter only takes effect if the MGMT VLAN parameter is enabled. Configure this parameter to set the value of the Priority code point field in the 802.1q tag for traffic on the management VLAN originating from the SM. The default value is 0.</p>
<b>Data VLAN</b>	<p>Enabled: <b>A VLAN tag will be added to all untagged traffic entering the SM's LAN port before sending it to the AP and remove tags in the opposite direction from traffic (tagged with Data VLAN ID) entering on the SM's WAN port before sending to the SM's LAN port.</b></p> <p>Disabled: <b>When disabled, no changes are made to untagged traffic passing through the SM.</b></p>

Attribute	Meaning
<b>Data VLAN ID</b>	<b>Configure this parameter to include this VLAN tag to all untagged traffic entering on the SM's LAN port before sending it to the AP and remove tags in the opposite direction from traffic (tagged with Data VLAN ID) entering on the SM's WAN port before sending to the SM's LAN port.</b>
<b>Data VLAN Priority</b>	ePMP radios can prioritize VLAN traffic based on the eight priorities described in the IEEE 802.1p specification. <b>Data VLAN Priority</b> represents the VLAN Priority or Class of Service (CoS). Operators may use this prioritization field to give precedence to device user data. This parameter only takes effect if the <b>Data VLAN</b> parameter is enabled. Configure this parameter to set the value of the Priority code point field in the 802.1q tag for traffic on the <b>Data VLAN</b> originating from the SM. The default value is 0.
<b>Membership VLANs</b>	Configure the <b>Membership VLAN Table</b> to include the SM in one or more VLANs. When the SM receives a packet tagged from either the Ethernet (LAN) or Wireless (WAN) side with a VLAN ID which is contained in the <b>Membership VLAN Table</b> , the packet is forwarded and sent out the other interface. When the SM receives a packet tagged with a VLAN ID which is not present in the <b>Membership VLAN Table</b> , the frame is dropped (assuming there is at least one VLAN ID present in the Membership VLAN table or configured as a Data VLAN).
<b>VLAN ID Begin</b>	Configure the first VLAN ID for the VLAN range.
<b>VLAN ID End</b>	Configure the last VLAN ID for the VLAN range.
<b>VLAN Mapping</b>	Configure the <b>VLAN Mapping Table</b> to map the C-VLAN of traffic ingressing the Ethernet (LAN) port of the SM to a S-VLAN before being forwarded to the air interface on the UL. In the DL direction, the SM will automatically un-map the S-VLAN to the C-VLAN before forwarding the tagged packets to the Ethernet (LAN) interface of the SM.
<b>C-VLAN</b>	Configure the C-VLAN ID of the tagged traffic for which the mapping needs to occur  Note The C-VLAN ID must be entered in the SM VLAN Membership VLAN table.
<b>S-VLAN</b>	Configure the S-VLAN ID to which the tagged traffic needs to be mapped to.  Note The S-VLAN ID must be entered in the SM VLAN Membership VLAN table.
Ethernet Port	
<b>Ethernet MTU</b>	<b>Maximum Transmission Unit; the size in bytes of the largest data unit that the device is configured to process. Larger MTU configurations can enable the network to operate with greater efficiency, but in the case of retransmissions due to packet errors, efficiency is reduced since large packets must be resent in the event of an error.</b>
<b>Ethernet Port</b>	<b>Disabled:</b> The primary Ethernet port is disabled <b>Enabled:</b> <b>The primary Ethernet port is enabled</b>

Attribute	Meaning
<b>Port Setting</b>	<p>Manual: <b>The LAN Ethernet port speed and duplex mode can be manually configured.</b></p> <p>Auto-negotiate: <b>The AP auto negotiates the LAN Ethernet port speed and duplex mode with the device connected to it.</b></p>
<b>Port Speed</b>	<b>With “Ethernet Port Configuration”, the LAN Ethernet port speed can be forced to 1000 Mbps (only GPS Sync’d radio), 100 Mbps or 10 Mbps.</b>
<b>Port Duplex Mode</b>	<b>With “Ethernet Port Configuration”, the LAN Ethernet port duplex mode can be forced to Full or Half.</b>
<b>Auxiliary Port</b>	<p>Disabled: <b>When disabled, the LAN Auxiliary port on the SM is shut down.</b></p> <p>Enabled: <b>When enabled, LAN Auxiliary port on the SM is up and able to bridge traffic with the primary Ethernet port. Default value is Enabled.</b></p>
<b>Auxiliary Port Setting</b>	<p>Manual: <b>The LAN Auxiliary port speed and duplex mode can be manually configured.</b></p> <p>Auto-negotiate: <b>The AP auto negotiates the LAN Auxiliary port speed and duplex mode with the device connected to it.</b></p>
<b>Auxiliary Port Speed</b>	<b>With “Auxiliary Port Configuration” set to Manual, the LAN Auxiliary port speed can be forced to 1000 Mbps (only GPS Synchronized radio), 100 Mbps or 10 Mbps.</b>
<b>Auxiliary Port Duplex Mode</b>	<b>With “Auxiliary Port Configuration” set to Manual, the LAN Auxiliary port duplex mode can be forced to Full or Half.</b>
<b>Auxiliary Port PoE</b>	<p>Disabled: <b>When disabled, the LAN Auxiliary port on the SM will not provide proprietary PoE out. Default value is Disabled.</b></p> <p>Enabled: <b>When enabled, LAN Auxiliary port on the SM will provide proprietary PoE out to power external PoE devices such as another ePMP radio or a PoE camera.</b></p>
Broadcast/Multicast Traffic Shaping	
<b>Broadcast Packet Limit</b>	<p><b>Enabled:</b> This allows the user to set the <b>Broadcast Packet Rate</b> below. Configure this parameter to limit the amount of broadcast packets that will be allowed on the ingress of the radio’s Ethernet port. Set the packets per second value to limit the impact of events such as broadcast storms.</p> <p><b>Disabled:</b> There is no limit on the amount of broadcast traffic that will be allowed into the ingress of the radio’s Ethernet port.</p>
<b>Broadcast Packet Rate</b>	Set the packets per second value to limit the amount of broadcast traffic that will be allowed on the ingress on the radio’s Ethernet port. The packets per second limit can be set individually on each ePMP radio. The range is 100 to 16000 packets per second. The default is <b>1000</b> .
<b>Multicast Group Limit</b>	Configure the maximum number of simultaneous multicast groups that the SM will allow from devices below it. The default is <b>3</b> .



Attribute	Meaning
<b>Multicast VLAN</b>	<p>Enabled: <b>A VLAN tag will be added to all untagged multicast traffic entering the SM's LAN port before sending it to the AP and remove tags in the opposite direction from traffic (tagged with Multicast VLAN ID) entering on the SM's WAN port before sending to the SM's LAN port.</b></p> <p>Disabled: When disabled, no changes are made to untagged multicast traffic passing through the SM.</p>
<b>Multicast VLAN ID</b>	<p>Configure this parameter to include this VLAN tag to all untagged <b>multicast</b> traffic entering on the SM's LAN port before sending it to the AP and remove tags in the opposite direction from multicast traffic (tagged with Multicast VLAN ID) entering on the SM's WAN port before sending to the SM's LAN port.</p>
<b>Multicast VLAN Priority</b>	<p>ePMP radios can prioritize VLAN traffic based on the eight priorities described in the IEEE 802.1p specification. <b>Multicast VLAN Priority</b> represents the VLAN Priority or Class of Service (CoS). Operators may use this prioritization field to give precedence to device <b>multicast</b> data.</p> <p>This parameter only takes effect if the <b>Multicast VLAN</b> parameter is enabled. Configure this parameter to set the value of the Priority code point field in the 802.1q tag for traffic on the <b>Multicast VLAN</b> originating from the SM. The default value is 0.</p>
Advanced	
<b>Spanning Tree Protocol</b>	<p>Disabled: <b>When disabled, Spanning Tree Protocol (802.1d) functionality is disabled at the SM.</b></p> <p>Enabled: When enabled, Spanning Tree Protocol (802.1d) functionality is enabled at the SM, allowing for the prevention of Ethernet bridge loops.</p>
<b>DHCP Servers Below SM</b>	<p>Disabled: <b>This blocks DHCP servers connected to the SM's LAN side from handing out IP addresses to DHCP clients above the SM (wireless side).</b></p> <p>Enabled: This allows DHCP servers connected to the SM's LAN side to assign IP addresses to DHCP clients above the SM (wireless side). This configuration is typical in PTP links.</p>
<b>NAT Helper For SIP</b>	<p>Disabled: <b>When disabled, the SM does not perform any deep packet manipulation on the SIP request packet from a SIP Client.</b></p> <p>Enabled: When enabled, the SM in NAT mode replaces the Source IP within the SIP request to the Wireless IP of the SM. Please note that this translation is often times handled by the SIP server so this option may not always be needed.</p>
<b>LLDP</b>	<p>The Link Layer Discovery Protocol (LLDP) is a vendor-neutral link layer protocol (as specified in IEEE 802.1AB) used by ePMP for advertising its identity, capabilities, and neighbors on the Ethernet/wired interface.</p> <p>Disabled: ePMP does not Receive or Transmit LLDP packets from/to its neighbors. Enabled: ePMP can Receive LLDP packets from its neighbors and Send LLDP packets to its neighbors, depending on the <b>LLDP Mode</b> configuration below.</p> <div style="background-color: #e0e0e0; padding: 5px;"> <p> <b>Note</b></p> <p>LLDP packets are Received/Transmitted ONLY to the neighbors on the Ethernet Interface of the ePMP radio.</p> </div>

---

Attribute	Meaning
<b>LLDP Mode</b>	<b>Receive and Transmit:</b> ePMP sends and receives LLDP packets to/from its neighbors on the Ethernet/LAN interface. <b>Receive Only:</b> ePMP receives LLDP packets from its neighbors on the Ethernet/LAN interface and discovers them.

---

Figure 73 SM Network page, Router mode

The screenshot displays the configuration page for a Subscriber Module in Router mode. The interface includes a navigation sidebar on the left with options like Home, Quick Start, Configuration, Radio, Quality of Service, System, Network (selected), Security, Monitor, and Tools. The main content area is titled 'Configuration > Network' and is divided into several sections:

- General:** Network Mode is set to Router. Wireless IP Assignment is set to DHCP with a Wireless IP Address of 192.168.0.2 and a Wireless Subnet Mask of 255.255.255.0. Ethernet Port Security is Disabled. Secure MAC Limit is 5, and MAC Aging Time is 300 seconds.
- Ethernet interface:** IP Address is 10.1.1.254 with Subnet Mask 255.255.255.0. DHCP Server is Enabled. DHCP Start IP is 10.1.1.1 and DHCP End IP is 10.1.1.10. DHCP Lease Time is 24 hours. A table for DHCP Clients is currently empty.
- Static Routes:** Static Routes are Disabled.
- IP Aliases:** IP Aliases are Disabled.
- Separate Wireless Management Interface:** Separate Management IP is Disabled. Separate Management VLAN is Disabled.
- Virtual Local Area Network (VLAN):** VLAN (Management - Data) is Disabled.
- Ethernet Port:** Ethernet MTU is 1500 bytes. Ethernet Port, Port Setting, Auxiliary Port, and Auxiliary Port PoE are all Enabled.
- Point-to-Point Protocol over Ethernet (PPPoE):** PPPoE is Disabled. Service Name is 'temp', Access Concentrator is 'Cambium', Authentication is ALL, Username and Password fields are empty, MTU Size is 1492 bytes, Keep Alive Time is 10, and MSS Clamping is Disabled.
- Advanced:** Spanning Tree Protocol, DHCP Server Below SM, NAT Helper For SIP, LLDP, and LLDP Mode (Receive and Transmit) are all Disabled.

**Table 122** SM Network attributes, Router mode

Attribute	Meaning
General	
<b>Network Mode</b>	<p><b>NAT:</b> The SM acts as a router and packets are forwarded or filtered based on their IP header (source or destination).</p> <p><b>Bridge:</b> The SM acts as a switch and packets are forwarded or filtered based on their MAC destination address.</p> <p><b>Router:</b> The SM acts as a router and packets are forwarded or filtered based on their IP header (source or destination) using specific static routes and IP aliases configured by the operator.</p>
<b>Wireless IP Assignment</b>	<p>Static: <b>Wireless IP addressing is configured manually in fields</b> Wireless IP Address, Wireless IP Subnet Mask, Wireless Gateway IP Address, Preferred DNS IP Address <b>and</b> Alternate DNS IP Address.</p> <p>DHCP: <b>Device management IP addressing (IP address, subnet mask, gateway and DNS server) is assigned via a network DHCP server.</b></p>
<b>Wireless IP Address</b>	<b>Wireless Internet protocol (IP) address. This address is used by the family of Internet protocols to uniquely identify this unit on a network.</b>
<b>Wireless Subnet Mask</b>	<b>Defines the address range of the connected IP network. For example, if Wireless IP Address is configured to 192.168.2.1 and Wireless IP Subnet Mask is configured to 255.255.255.0, the device wireless interface will belong to subnet 192.168.2.X.</b>
<b>Wireless Gateway</b>	<b>Configure the IP address of a computer on the current network that acts as a gateway. A gateway acts as an entrance and exit to packets from and to other networks.</b>
<b>Preferred DNS Server</b>	<b>Configure The IP address of the preferred server used for DNS resolution.</b>
<b>Alternate DNS Server</b>	<b>Configure The IP address of the alternate server used for DNS resolution.</b>
<b>Ethernet Port Security</b>	<p>Disabled: <b>When disabled, any number of devices (MAC Addresses) can connect via the SM's Ethernet (LAN) port.</b></p> <p>Enabled: <b>When enabled, the number of devices (MAC Addresses) that can connect via the SM's Ethernet (LAN) port can be restricted with the fields below.</b></p>
<b>Secure MAC Limit</b>	<b>Specify the maximum number of unique devices (MAC Addresses) that can connect via the SM's Ethernet (LAN) port. Range is 1 – 254 devices.</b>
<b>MAC Aging Time</b>	<b>Specify the aging timer in seconds. The aging timer will determine the duration for which the SM will maintain the MAC Address in its bridge table. The timer is restarted any time traffic from a specific MAC address is received on the LAN port. Once the timer expires, the MAC Address is removed from the SM's bridge table.</b>
Ethernet Interface	

Attribute	Meaning
<b>IP Address</b>	<b>Internet protocol (IP) address. This address is used by the family of Internet protocols to uniquely identify this unit on a network.</b>
<b>Subnet Mask</b>	<b>Defines the address range of the connected IP network. For example, if Device IP Address (LAN) is configured to 192.168.2.1 and IP Subnet Mask (LAN) is configured to 255.255.255.0, the device will belong to subnet 192.168.2.X.</b>
<b>DHCP Server</b>	<p>Disabled: Use this setting when SM is in NAT mode, if there is an existing DHCP Server below the SM handing out IP Addresses or if all devices below the SM will be configured with static IP Addresses.</p> <p>Enabled: Use this setting when SM is in NAT mode, to use the SM's local/onboard DHCP server to hand out IP addresses to its clients.</p>
<b>DHCP Start IP</b>	<b>Configure the first address which will be issued to a DHCP client. Upon additional DHCP requests, the DHCP Start IP is incremented until Local DHCP End IP is reached.</b>
<b>DHCP End IP</b>	<b>Configure the highest IP address in the DHCP pool that can be issued to a DHCP client.</b>
<b>Preferred DHCP DNS Server</b>	<b>Configure the primary DNS Server IP address which will be used to configure DHCP clients (if Local DHCP Server is set to Enabled).</b>
<b>Alternate DHCP DNS Server</b>	<b>Configure the secondary DNS Server IP address which will be used to configure DHCP clients (if Local DHCP Server is set to Enabled).</b>
<b>DHCP Lease Time</b>	<b>Configure the time for which a DHCP IP address is leased. When the lease time expires, the DHCP client must renew IP addressing via DHCP request.</b>
<b>DHCP Clients</b>	<b>The DHCP Client List table identifies hardware situated below the SM which shall be issued DHCP IP addressing information. The SM acts as a DHCP server, responding to requests from hardware connected to the SM.</b>
<b>MAC</b>	<b>Configure the physical address of the device which will retrieve DHCP IP addressing information from the SM.</b>
<b>IP</b>	<b>Configure the IP address which will be assigned to the device.</b>
<b>Name</b>	<b>Configure a logical name for the device configured (i.e. VoIP Phone1, or Network Camera1).</b>
<b>Static Routes</b>	

Attribute	Meaning
Route	<p><b>When Enabled, it allows the operator to create static routes that will apply to both the Wireless and Ethernet interface of the SM.</b></p> <p>This allows operators to configure a custom table of explicit paths between networks. Static routing is often used as a method to reduce the overhead of processing dynamic routes through a network when the specific path is known (or, it is simpler to define a specific path). Static routing is also used as a backup when dynamic routing protocols fail to complete a route from one network to another.</p> <p>In router mode, the Static Routes table is referenced by the SM to forward/filter packets to a particular destination configured by the user based on the IP addressing information contained in the table.</p> <p>Since static routes do not change with network changes, it is recommended to only use static routes for simple network paths which are not prone to frequent changes (requiring updates to the routes configured on the ePMP SM).</p> <p>It is important to consider each hop in a static route's path to ensure that the routing equipment has been configured to statically or dynamically route packets to the proper destination. Otherwise, the network communication will fail.</p> <div style="background-color: #f0f0f0; padding: 5px;">  <b>Note</b>        Network Address Translation (NAT) is not performed when the SM is in Router mode.     </div>
Target Network IP	Configure the target subnet/network's IP address to which the SM should route the packets.
Subnet Mask	Configure the subnet mask for the Target Network IP address.
Gateway	Configure the gateway to which packets that match the Target Network IP Address and Subnet Mask are sent.
Description	Provide a description to easily identify the static route and its purpose.
Separate Wireless Management Interface	
Separate Management IP	<p>Disabled: <b>When disabled, the Wireless IP is the management interface for the SM.</b></p> <p>Enabled: <b>When enabled, the IP Address below is the management interface for the SM.</b></p>
IP Assignment	<p>Static: <b>Separate Wireless Management Interface is configured manually in fields IP Address, Subnet Mask and Gateway.</b></p> <p>DHCP: <b>Management IP addressing (IP address, subnet mask, gateway and DNS server) is assigned via a network DHCP server.</b></p>

Attribute	Meaning
<b>IP Address</b>	<b>Configure the IP address that will be used to access the SM's management interface when in NAT mode. The Wireless IP (public IP) will not allow management access.</b>
<b>Subnet Mask</b>	<b>Defines the address range of the connected IP network. For example, if IP Address is configured to 192.168.2.1 and Subnet Mask is configured to 255.255.255.0, the device wireless interface will belong to subnet 192.168.2.X.</b>
<b>Gateway</b>	<b>Configure the IP address of a computer on the current network that acts as a gateway. A gateway acts as an entrance and exit to packets from and to other networks.</b>
<b>Separate Management VLAN</b>	<p><b>Enabled: A VLAN configuration establishes a logical group within the network. Each computer in the VLAN, regardless of initial or eventual physical location, has access to the same data based on the VLAN architecture. For the network operator, this provides flexibility in network segmentation, simpler management and enhanced security. When the SM is in NAT mode, the Separate Wireless Management VLAN configuration is applicable to management data.</b></p> <p><b>Disabled: When disabled, the SM does not have a unique management VLAN.</b></p>
<b>VLAN ID</b>	<b>Configure this parameter to include the device's management traffic on a separate VLAN network.</b>
<b>VLAN Priority</b>	<p>ePMP radios can prioritize VLAN traffic based on the eight priorities described in the IEEE 802.1p specification. <b>Data VLAN Priority</b> represents the VLAN Priority or Class of Service (CoS). Operators may use this prioritization field to give precedence to device management data.</p> <p><b>This parameter only takes effect if the Separate Wireless Management VLAN parameter is enabled. Configure this parameter to set the value of the Priority code point field in the 802.1q tag for management traffic on the configured VLAN ID originating from the SM. The default value is 0.</b></p>
Virtual Local Area Management (VLAN)	
<b>VLAN (Management + Data)</b>	<p><b>Enabled: A VLAN configuration establishes a logical group within the network. Each computer in the VLAN, regardless of initial or eventual physical location, has access to the same data based on the VLAN architecture. For the network operator, this provides flexibility in network segmentation, simpler management and enhanced security. When the SM is in NAT or Router mode, the VLAN configuration is applicable to both management and user data.</b></p> <p><b>Disabled: When disabled, all IP management and data traffic is allowed to the device.</b></p>
<b>VLAN ID</b>	<b>Configure this parameter to include the device's management and user traffic on a separate VLAN network.</b>

Attribute	Meaning
<b>VLAN Priority</b>	<p>ePMP radios can prioritize VLAN traffic based on the eight priorities described in the IEEE 802.1p specification. <b>Data VLAN Priority</b> represents the VLAN Priority or Class of Service (CoS). Operators may use this prioritization field to give precedence to device user and management data.</p> <p>This parameter only takes effect if the <b>VLAN</b> parameter is enabled. Configure this parameter to set the value of the Priority code point field in the 802.1q tag for traffic on the configured VLAN ID originating from the <b>SM</b>. The default value is 0.</p>
IP Aliases	
<b>IP aliases</b>	<p><b>When Enabled, IP aliases allow the operator to associate more than one IP address to the Ethernet interface of the SM.</b></p> <p>This configuration of multiple IP addresses for the SM's Ethernet interface allows connections to multiple networks, often used as a mechanism for management access to the device from a convenient networking path.</p>
<b>IP Address</b>	Configure the IP address for the alias.
<b>Subnet Mask</b>	Configure the subnet mask for the alias.
<b>Description</b>	Provide a description to easily identify the IP alias and its purpose/connected network.
Ethernet Port	
<b>Ethernet MTU</b>	Maximum Transmission Unit; the size in bytes of the largest data unit that the device is configured to process. Larger MTU configurations can enable the network to operate with greater efficiency, but in the case of retransmissions due to packet errors, efficiency is reduced since large packets must be resent in the event of an error.
<b>Ethernet Port</b>	<p><b>Disabled:</b> The primary Ethernet port is disabled</p> <p><b>Enabled:</b> The primary Ethernet port is enabled</p>
<b>Port Setting</b>	<p><b>Manual:</b> <b>The LAN Ethernet port speed and duplex mode can be manually configured.</b></p> <p><b>Auto-negotiate:</b> The AP auto negotiates the LAN Ethernet port speed and duplex mode with the device connected to it.</p>
<b>Port Speed</b>	With "Ethernet Port Configuration" set to Manual, the LAN Ethernet port speed can be forced to 1000 Mbps (only GPS Synchronized radio), 100 Mbps or 10 Mbps.
<b>Port Duplex Mode</b>	With "Ethernet Port Configuration" set to Manual, the LAN Ethernet port duplex mode can be forced to Full or Half.
<b>Auxiliary Port</b>	<p><b>Disabled:</b> <b>When disabled, the LAN Auxiliary port on the SM is shut down.</b></p> <p><b>Enabled:</b> When enabled, LAN Auxiliary port on the SM is up and able to bridge traffic with the primary Ethernet port. Default value is Enabled.</p>
<b>Auxiliary Port Configuration</b>	<p><b>Manual:</b> <b>The LAN Auxiliary port speed and duplex mode can be manually configured.</b></p> <p><b>Auto-negotiate:</b> The AP auto negotiates the LAN Auxiliary port speed and duplex mode with the device connected to it.</p>



Attribute	Meaning
<b>Auxiliary Port Speed</b>	With “Auxiliary Port Configuration” set to Manual, the LAN Auxiliary port speed can be forced to 1000 Mbps (only GPS Synchronized radio), 100 Mbps or 10 Mbps.
<b>Auxiliary Port Duplex Mode</b>	With “Auxiliary Port Configuration” set to Manual, the LAN Auxiliary port duplex mode can be forced to Full or Half.
<b>Auxiliary Port PoE</b>	<p><b>Disabled:</b> <b>When disabled, the LAN Auxiliary port on the SM will not provide proprietary PoE out. Default value is Disabled.</b></p> <p><b>Enabled:</b> When enabled, LAN Auxiliary port on the SM will provide proprietary PoE out to power external PoE devices such as another ePMP radio or a PoE camera.</p>
Advanced	
<b>Spanning Tree Protocol</b>	<p><b>Disabled:</b> <b>When disabled, Spanning Tree Protocol (802.1d) functionality is disabled at the SM.</b></p> <p><b>Enabled:</b> <b>When enabled, Spanning Tree Protocol (802.1d) functionality is enabled at the SM, allowing for the prevention of Ethernet bridge loops.</b></p>
<b>DHCP Servers Below SM</b>	<p><b>Disabled:</b> <b>This blocks DHCP servers connected to the SM’s LAN side from handing out IP addresses to DHCP clients above the SM (wireless side).</b></p> <p><b>Enabled:</b> <b>This allows DHCP servers connected to the SM’s LAN side to assign IP addresses to DHCP clients above the SM (wireless side). This configuration is typical in PTP links.</b></p>
<b>NAT Helper For SIP</b>	<p><b>Disabled:</b> <b>When disabled, the SM does not perform any deep packet manipulation on the SIP request packet from a SIP Client.</b></p> <p><b>Enabled:</b> <b>When enabled, the SM in NAT mode replaces the Source IP within the SIP request to the Wireless IP of the SM. Please note that this translation is often times handled by the SIP server so this option may not always be needed.</b></p>
<b>LLDP</b>	<p>The Link Layer Discovery Protocol (LLDP) is a vendor-neutral link layer protocol (as specified in IEEE 802.1AB) used by ePMP for advertising its identity, capabilities, and neighbors on the Ethernet/wired interface.</p> <p><b>Disabled:</b> ePMP does not Receive or Transmit LLDP packets from/to its neighbors.</p> <p><b>Enabled:</b> ePMP can Receive LLDP packets from its neighbors and Send LLDP packets to its neighbors, depending on the <b>LLDP Mode</b> configuration below.</p> <div style="background-color: #f0f0f0; padding: 5px; margin-top: 10px;">  <b>Note</b>  LLDP packets are Received/Transmitted ONLY to the neighbors on the Ethernet Interface of the ePMP radio. </div>
<b>LLDP Mode</b>	<p><b>Receive and Transmit:</b> ePMP sends and receives LLDP packets to/from its neighbors on the Ethernet/LAN interface.</p> <p><b>Receive Only:</b> ePMP receives LLDP packets from its neighbors on the Ethernet/LAN interface and discovers them.</p>
Point-to-Point Protocol over Ethernet (PPPoE)	

Attribute	Meaning
PPPoE	Point-to-Point Protocol over Ethernet: <b>Used for Encapsulating PPP frames inside Ethernet frames.</b>
Service Name	<b>An optional entry to set a specific service name to connect to for the PPPoE session. If this is left blank the SM accepts the first service option that comes back from the Access Concentrator specified below, if any. This is limited to 32 characters.</b>
Access Concentrator	<b>An optional entry to set a specific Access Concentrator to connect to for the PPPoE session. If this is blank, the SM accepts the first Access Concentrator which matches the service name (if specified). This is limited to 32 characters.</b>
Authentication	<p><b>ALL: This means that CHAP authentication will be attempted first, then PAP authentication. The same password is used for both types.</b></p> <p><b>CHAP: This means that CHAP authentication will be attempted.</b></p> <p><b>PAP: This means that PAP authentication will be attempted.</b></p>
Username	<b>This is the CHAP/PAP username that is used. This is limited to 32 characters.</b>
Password	<b>This is the CHAP/PAP password that is used. This is limited to 32 characters.</b>
MTU Size	<b>Maximum Transmission Unit; the size in bytes of the largest data unit that the device is configured to process inside the PPPoE tunnel. This field allows the operator to specify the largest MTU value to use in the PPPoE session, if PPPoE MSS Clamping is Enabled. The user will be able to enter an MTU value up to 1492. However, if the MTU determined in LCP negotiations is less than this user-specified value, the SM uses the smaller value as its MTU for the PPPoE link.</b>
Keep Alive Time	<b>Configure the Keep Alive Time to allow the radio to keep the PPPoE session up after establishment. As an example, if this field is set to 5, the PPPoE client will send a keep alive message to the PPPoE server every 5 seconds. If there is no acknowledgement, it sends the 'Keep alive' message to the server 4 more times (for a total of 5 times) before tearing down the PPPoE session. Setting this to 12 will mean the keep alive message will be sent every 12 seconds and when there is no acknowledgement, the client will try for a total of 12 times every 12 seconds before tearing down the PPPoE session.</b>
MSS Clamping	<p><b>Disabled: The SM PPPoE session allows any MTU size determined by other devices in the PPPoE session during the LCP negotiations.</b></p> <p><b>Enabled: The SM PPPoE session enforces a max MTU size determined by the PPPoE MTU Size setting for all devices in the PPPoE session during the LCP negotiations, unless one of the devices enforces a MTU setting that is smaller in value.</b></p>

### SM Security page

The SM's **Security** page is used to configure system security features including SM authentication and Layer2/Layer3 Firewall rules.



**Caution**

If a device firewall rule is added with **Action** set to **Deny** and **Interface** set to **LAN** or **WAN** and no other rule attribute are configured, the device will drop all Ethernet or wireless traffic, respectively. Ensure that all firewall rules are specific to the type of traffic which must be denied, and that no rules exist in the devices with only **Action** set to **Deny** and **Interface** set to **LAN** or **WAN**. To regain access to the device, perform a factory default.

Figure 74 SM Security page

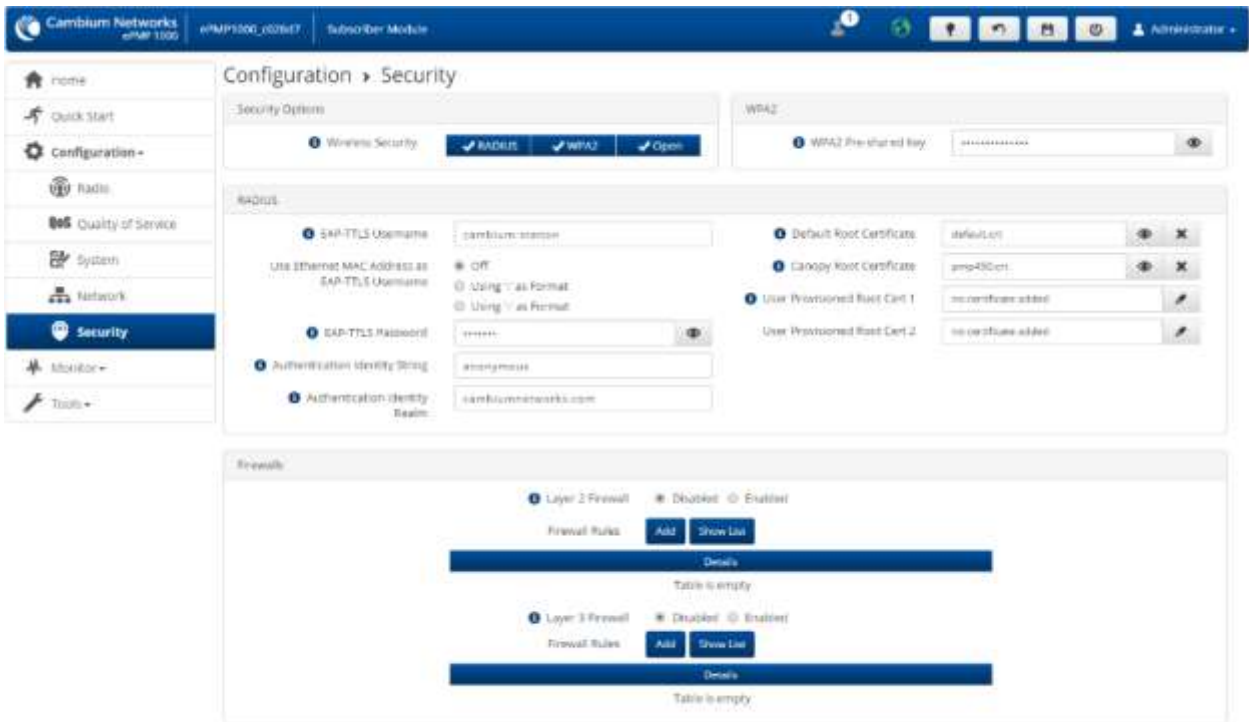

© 2018 Cambium Networks, All Rights Reserved | Version 3.1 | Support | Community Forum

**Table 123** SM Security attributes

Attribute	Meaning
Security Options	
<b>Wireless Security</b>	<b>Select the type of authentication preferred, whether RADIUS, WPA2, Open or a combination of the three.</b>
WPA2	
<b>WPA2 Pre-shared Key</b>	<b>Configure this key on the AP and then configure each of the network SMs with this key to complete the authentication configuration. This key must be between 8 to 128 symbols.</b>
RADIUS	
<b>EAP-TTLS Username</b>	<b>Configure the EAP-TTLS Username to match the credentials on the RADIUS server being used for the network.</b>
<b>Use Ethernet MAC Address at EAP-TTLS Username</b>	<b>The device MAC Address can be used as the EAP-TTLS Username in either ":" or "-" delimited format.</b>
<b>EAP-TTLS Password</b>	<b>Configure the EAP-TTLS Password to match the credentials on the RADIUS server being used for the network.</b>
<b>Authentication Identity String</b>	<b>Configure this Identity string to match the credentials on the RADIUS server being used for the network. Default value for this parameter is "anonymous".</b>
<b>Authentication Identity Realm</b>	<b>Configure this Identity string to match the credentials on the RADIUS server being used for the network. Default value for this parameter is "cambiumnetworks.com".</b>
<b>Default Root Certificate</b>	<b>Default EAP-TTLS root certificate that must match the certificate on the RADIUS server.</b>
<b>Canopy Root Certificate</b>	<b>PMP 450 default EAP-TTLS root certificate to match the certificate on the RADIUS server used with current PMP 450 installations.</b>
<b>User Provisioned Root Cert 1</b>	<b>Import a user certificate if a certificate different from the default certificates is needed.</b>
<b>User Provisioned Root Cert 2</b>	<b>Import a second user certificate if a certificate different from the default or 1<sup>st</sup> user provisioned certificate is needed.</b>
Firewalls	
<b>Layer 2 Firewall</b>	<p>Enabled: <b>Modifications to the Layer 2 Firewall Table are allowed and rules are enforced.</b></p> <p>Disabled: <b>Modifications to the Layer 2 Firewall Table are not allowed and rules are not enforced.</b></p>

---

Attribute	Meaning
<b>Firewall Rules</b>	<b>The Layer 2 firewall table may be used to configure rules matching layer 2 (MAC layer) traffic which result in forwarding or dropping the traffic over the radio link or Ethernet interface.</b>
	
	Note
	When the SM is in NAT mode, only the <b>Src MAC</b> filtering functionality is supported
<b>Layer 3 Firewall</b>	<b>Disabled: Modifications to the Layer 3 Firewall Table are not allowed and rules are not enforced.</b>
	<b>Enabled: Modifications to the Layer 3 Firewall Table are allowed and rules are enforced.</b>
<b>Firewall Rules</b>	<b>The Layer 3 firewall table may be used to configure rules matching layer 3 (IP layer) traffic which result in forwarding or dropping the traffic over the radio link or Ethernet interface.</b>

---

## SM MONITOR MENU

Use the **Monitor** menu to access device and network statistics and status information. This section may be used to analyze and troubleshoot network performance and operation.

The **Monitor** menu contains the following pages:

- SM Performance page on page [247](#)
- SM System page on page 251
- **SM Wireless page** on page [252](#)
- **SM Throughput Chart page** on page [256](#)
- **SM Network page** on page [256](#)
- **SM System Log page** on page [266](#)

### SM Performance page

Use the Performance page to monitor system status and statistics to analyze and troubleshoot network performance and operation.

Figure 75 SM Performance page

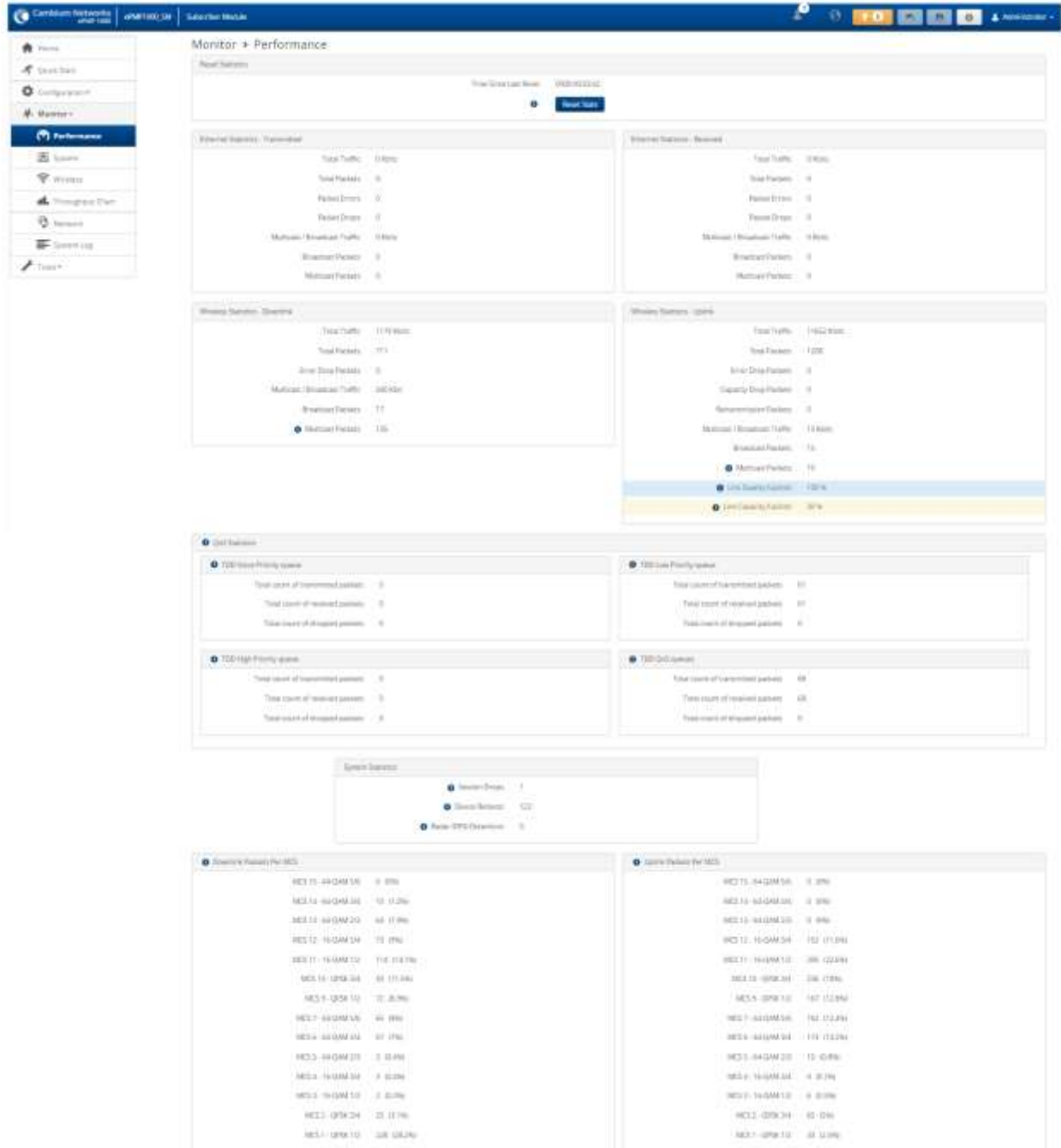

**Table 124** SM Performance attributes

Attribute	Meaning
Time Since Last Reset	Time since the stats were last reset.
Reset Stats	Resets all statistics for both Ethernet and Wireless.
Ethernet Statistics - Transmitted	
Total Traffic	Total amount of traffic in Kbits transferred from the SM's Ethernet interface.
Total Packets	Total number of packets transferred from the SM's Ethernet interface.
Packet Errors	Total number of packets transmitted out of the SM's Ethernet interface with errors due to collisions, CRC errors, or irregular packet size.
Packet Drops	Total number of packets dropped prior to sending out of the SM's Ethernet interface due to Ethernet setup or filtering issues.
Multicast / Broadcast Traffic	Total amount of multicast and broadcast traffic in Kbits sent via the SM's Ethernet interface.
Broadcast Packets	Total number of broadcast packets sent via the SM's Ethernet interface.
Multicast Packets	Total number of multicast packets sent via the SM's Ethernet interface.
Ethernet Statistics - Received	
Total Traffic	Total amount of traffic in Kbits received by the SM's Ethernet interface.
Total Packets	Total number of packets received by the SM's Ethernet interface.
Packet Errors	Total number of packets received by the SM's Ethernet interface with errors due to collisions, CRC errors, or irregular packet size.
Packet Drops	Total number of packets dropped prior to sending out of the SM's wireless interface due to Ethernet setup or filtering issues.
Multicast / Broadcast Traffic	Total amount of multicast and broadcast traffic in Kbits received by the SM's Ethernet interface.
Broadcast Packets	Total number of broadcast packets received via the SM's Ethernet interface.
Multicast Packets	Total number of multicast packets received via the SM's Ethernet interface.
Wireless Statistics - Downlink	
Total Traffic	Total amount of traffic received via the SM's wireless interface in Kbits.
Total Packets	Total number of packets received via the SM's wireless interface.
Error Drop Packets	Total number of packets dropped prior to sending out of the SM's Ethernet interface due to RF errors (packet integrity error and other RF related packet error).
Multicast / Broadcast Traffic	Total amount of multicast and broadcast traffic transmitted out of the SM's wireless interface in Kbits.
Broadcast Packets	Total number of broadcast packets transmitted out of the SM's wireless interface.
Multicast Packets	Total number of multicast packets transmitted out of the SM's wireless interface.



Attribute	Meaning
Wireless Statistics - Uplink	
Total Traffic	Total amount of traffic transmitted out of the SM's wireless interface in Kbits.
Total Packets	Total number of packets transmitted out of the SM's wireless interface.
Error Drop Packets	Total number of packets dropped after transmitting out of the SM's Wireless interface due to RF errors (No acknowledgement and other RF related packet error).
Capacity Drop Packets	Total number of packets dropped after transmitting out of the SM's Wireless interface due to capacity issues (data buffer/queue overflow or other performance or internal packet errors).
Retransmission Packets	Total number of packets re-transmitted after transmitting out of the SM's Wireless interface due to the packets not being received by the AP.
Multicast / Broadcast Traffic	Total amount of multicast and broadcast traffic received on the SM's wireless interface in Kbits.
Broadcast Packets	Total number of broadcast packets transmitted on the SM's wireless interface.
Multicast Packets	Total number of multicast packets transmitted on the SM's wireless interface.
Link Quality (Uplink)	The Uplink quality based on the current MCS and PER.
Link Capacity (Uplink)	The uplink capacity based on the current MCS with respect to the highest supported MCS (MCS15).
QoS Statistics	
TDD Voice Priority Queue	
Total count of transmitted packets	Total count of put packets to Voice queue
Total count of received packets	Total count of get packets from Voice queue
Total count of dropped packets	Total count of dropped packets from Voice queue
TDD High Priority Queue	
Total count of transmitted packets	Total count of put packets to High queue
Total count of received packets	Total count of get packets from High queue
Total count of dropped packets	Total count of dropped packets from High queue
TDD Low Priority Queue	

Attribute	Meaning
Total count of transmitted packets	Total count of put packets to Low queue
Total count of received packets	Total count of get packets from Low queue
Total count of dropped packets	Total count of dropped packets from Low queue
TDD QoS queues	
Total count of transmitted packets	Total count of put packets to all queues
Total count of received packets	Total count of get packets from all queues
Total count of dropped packets	Total count of dropped packets from all queues
System Statistics	
Session Drops	Total number of sessions dropped by the SM.
Device Reboots	Total number of reboots of the SM.
Radar (DFS) Detections	Total number of DFS events that were detected by the SM.
Downlink Packets Per MCS	Number of packets (and percentage of total packets) received on the SM's wireless interface for every modulation mode, based on radio conditions.
Uplink Packets Per MCS	Number of packets (and percentage of total packets) transmitted out of the SM's wireless interface for every modulation mode used by the SM's transmitter, based on radio conditions.

## SM System page

Use the **System** page to reference key system information.

**Figure 76** SM System page

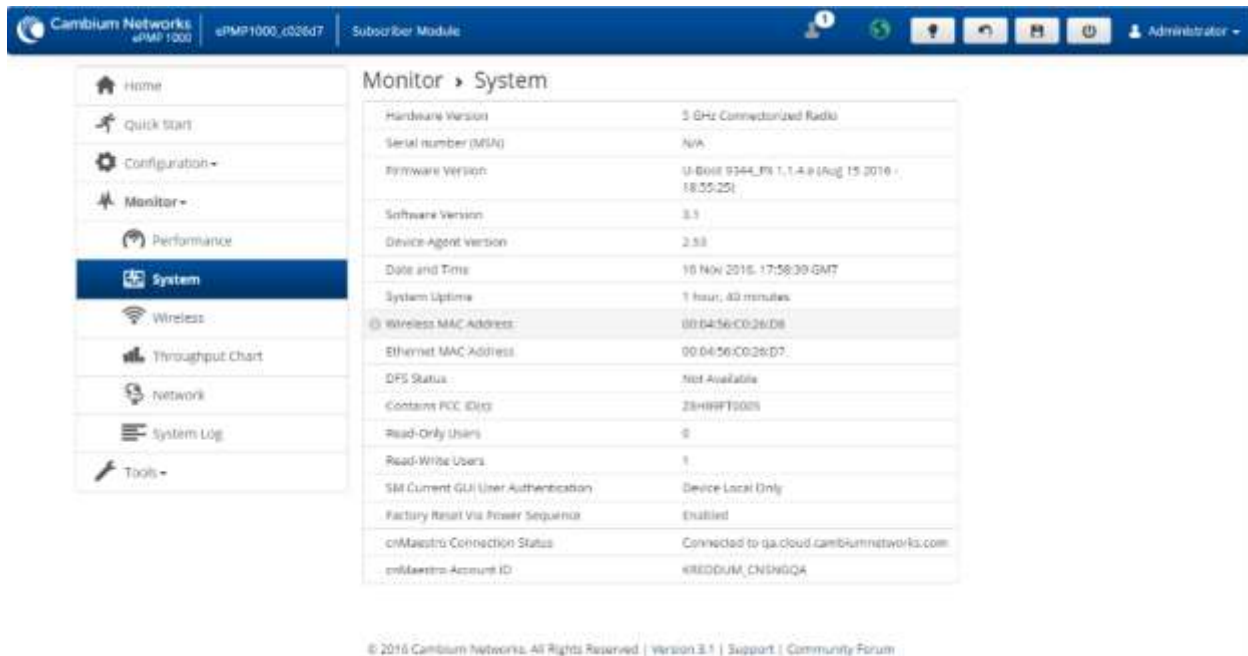

**Table 125** SM System page attributes

Attribute	Meaning
Hardware Version	Board hardware version information.
Serial Number (MSN)	Unit serial number (MSN).
Firmware Version	U-Boot version information.
Software Version	Current operating version of software on the device. This listing is also present on the GUI footer bar (which contains a hyperlink to download new system software).
Device-Agent Version	The operating version of the device agent, which is used for communication with cnMaestro.
Date and Time	Current date and time, subject to time zone offsets introduced by the configuration of the device <b>Time Zone</b> parameter. This shows a factory-configured time until a valid NTP server is configured.
System Uptime	The total system uptime since the last device reset.
Wireless MAC Address	The hardware address of the device wireless interface.
Ethernet MAC Address	The hardware address of the device Ethernet interface.

Attribute	Meaning
DFS Status	<p><b>N/A:</b> DFS operation is not required for the region configured in parameter <b>Country Code</b></p> <p><b>Channel Availability Check:</b> Prior to transmitting, the device must check the configured <b>Frequency Carrier</b> for radar pulses for 60 seconds). If no radar pulses are detected, the device transitions to state <b>In-Service Monitoring</b>.</p> <p><b>In-Service Monitoring:</b> Radio is transmitting and receiving normally while monitoring for radar pulses which require a channel move.</p> <p><b>Radar Signal Detected:</b> The receiver has detected a valid radar pulse and is carrying out detect-and-avoid mechanisms (moving to an alternate channel).</p> <p>In-Service Monitoring at Alternative Channel: The radio has detected a radar pulse and has moved operation to a frequency configured in DFS Alternative Frequency Carrier 1 or DFS Alternative Frequency Carrier 2.</p> <p><b>System Not In Service due to DFS:</b> The radio has detected a radar pulse and has failed channel availability checks on all alternative frequencies. The non-occupancy time for the radio frequencies in which radar was detected is 30 minutes.</p>
Contains FCC ID(s)	Displays listing of FCC IDs applicable to the device.
Read-Only Users	Displays the number of active Read-Only users logged into the radio.
Read-Write Users	Displays the number of active Read-Write users logged into the radio.
SM Current GUI User Authentication	Displays the mechanism used for authentication of web management interface users.
Factory Reset Via Power Sequence	<p><b>Enabled:</b> When Enabled under Tools-&gt;Backup/Restore-&gt;Reset Via Power Sequence, it is possible to reset the radio's configuration to factory defaults using the power cycle sequence explained under <b>Resetting ePMP to factory defaults by power cycling</b> on page <b>306</b>.</p> <p><b>Disabled:</b> When Disabled, it is not possible to factory default the radio's configuration using the power cycle sequence.</p>
cnMaestro Connection Status	The current management status of the device with respect to the Cambium Cloud Server. When Enabled under Configuration->System, the device will be managed by the Cambium Remote Management System, which allows all Cambium devices to be managed from the Cambium Cloud Server.
cnMaestro Account ID	The ID that the device is currently using to be managed by the Cambium Cloud Server.

### **SM Wireless page**

Use the **Wireless** page to reference key information about the radio's wireless interface.

Figure 77 SM Wireless page

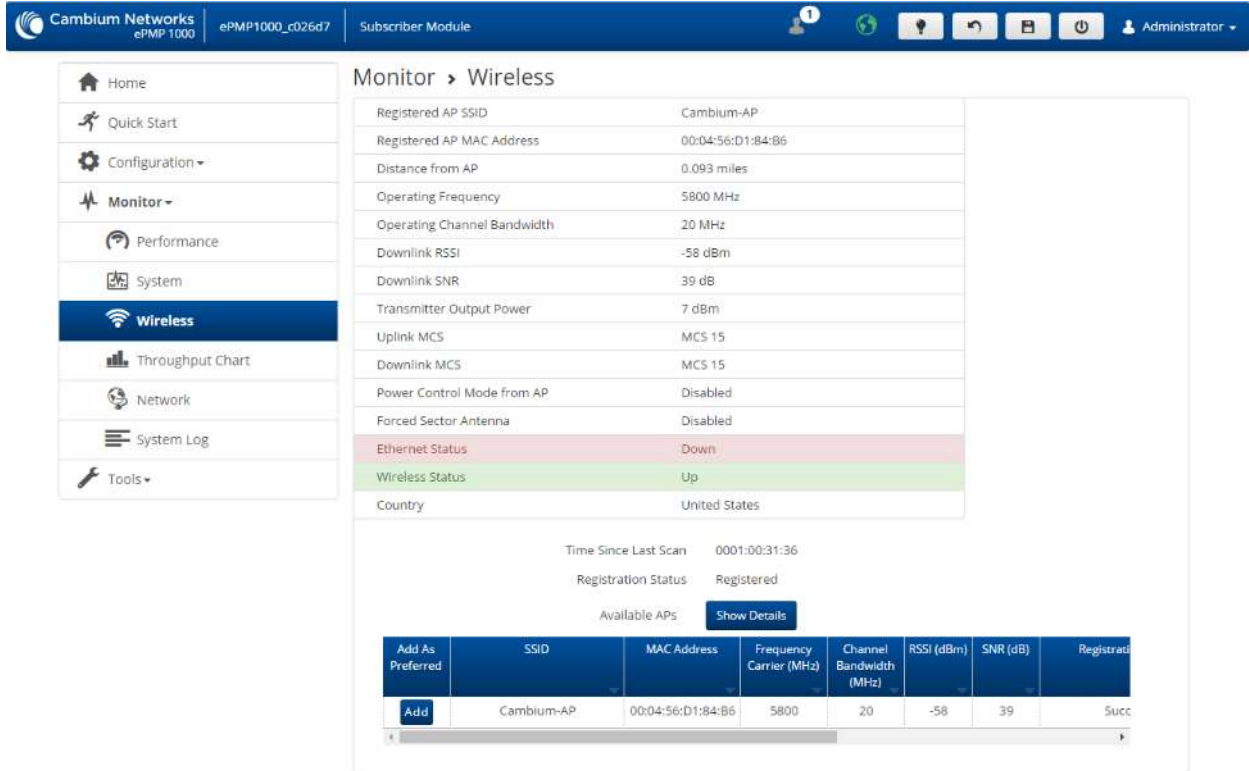

© 2016 Cambium Networks, All Rights Reserved | Version 3.1 | Support | Community Forum

Table 126 SM Wireless page attributes

Attribute	Meaning
Registered AP SSID	SSID of the AP to which the SM is registered.
Registered AP MAC address	Wireless MAC address of the AP to which the SM is registered.
Distance from AP	The distance from the AP, determined by radio signal propagation delay.
Operating Frequency	The current frequency at which the SM is transmitting and receiving.
Operating Channel Bandwidth	The current channel size at which the SM is transmitting and receiving.
Downlink RSSI	The Received Signal Strength Indicator, which is a measurement of the power level being received by the SM’s antenna.
Downlink SNR	The Signal to Noise Ratio, which is an expression of the carrier signal quality with respect to signal noise.
Transmitter Output Power	The current power level at which the SM is transmitting.
Uplink MCS	Modulation and Coding Scheme – indicates the modulation mode used for the radio uplink, based on radio conditions (MCS 1-7, 9-15).
Downlink MCS	Modulation and Coding Scheme – indicates the modulation mode used for the radio downlink, based on radio conditions (MCS 1-7, 9-15).

Attribute	Meaning
Power Control Mode from AP	<p><b>Open Loop:</b> In this mode, the SM will not receive any power change information in the Group Poll Frame. SM calculates the UL transmit power based on path loss calculations only.</p> <p><b>Closed Loop:</b> In closed loop UL power control, Subscriber Module will get the AP actual transmit power of beacon frame and <b>SM Target Received Power Level</b> in the beacon. Based on these two values, SM calculates the path loss. Based on path loss and TRL values it calculates its transmit power such that the signal from SM arrives at AP at the configured target level. Path loss calculation will be updated by SM every time there is a change in values of AP actual TX power or TRL in the Beacon.</p>
Forced Sector Antenna	When an ePMP 2000 AP is deployed with a Sector Antenna and a Smart Antenna, this parameter forces the AP to use only Sector Antenna for all Subscriber Modules.
Ethernet Interface	<p><b>Up:</b> The radio (LAN) interface is functioning properly.</p> <p><b>Down:</b> The radio (LAN) interface has encountered an error and is not servicing traffic.</p>
Wireless Interface	<p><b>Up:</b> The radio (WAN) interface is functioning properly.</p> <p><b>Down:</b> The radio (WAN) interface has encountered an error and is not servicing traffic.</p>
Country	The current code the SM is operating under.
Time since last scan	Amount of time elapsed since the last scan was completed by the SM for available APs.
Registration Status	The current registration status of the SM.
Available APs	The <b>Available AP list</b> may be referenced to view which APs are available for SM network entry, and also to view the status of the current AP to SM radio link.
Add as Preferred	Click the  button to add the AP to the <b>Preferred AP List</b> under Configuration->Radio.
SSID	The SSID of the visible AP.
MAC Address	The MAC address of the visible AP.
Frequency Carrier (MHz)	The current operating frequency of the visible AP.
Channel Bandwidth	The current operating channel bandwidth of the visible AP.
RSSI (dBm)	The current measured Received Signal Strength Indicator at the AP.
SNR (dB)	The current measured Signal-to-Noise Ratio of the SM to AP link.

Attribute	Meaning
Registration State	<p>The indication of the result of the SM's network entry attempt:</p> <p><b>Successful:</b> SM registration is successful</p> <p><b>Failed: Out of Range:</b> The SM is out of the AP's configured maximum range (<b>Max Range</b> parameter)</p> <p><b>Failed: Capacity limit reached at AP:</b> The AP is no longer allowing SM network entry due to capacity reached</p> <p><b>Failed: No Allocation on AP:</b> The SM to AP handshaking failed due to a misconfigured pre-shared key between the SM and AP</p> <p><b>Failed: SW Version Incompatibility:</b> The version of software resident on the AP is older than the software version on the SM</p> <p><b>Failed: PTP Mode: ACL Policy:</b> The AP is configured with <b>PTP Access</b> set to <b>MAC Limited</b> and the SM's MAC address is not configured in the AP's <b>PTP MAC Address</b> field</p> <p><b>Failed: Other:</b> The AP does not have the required available memory to allow network entry</p>
Session Time (hh:mm:ss)	This timer indicates the time elapsed since the SM registered to the AP.
Wireless Security	This field indicates the security state of the AP to SM link.
Meets Reg Criteria	<p><b>Yes:</b> The scanned AP meets the Network Entry criteria defined by the internal Network Algorithm.</p> <p><b>No:</b> The scanned AP does not meet the Network Entry criteria defined by the internal Network Algorithm.</p>

### SM Throughput Chart page

Use the Throughput page to reference a line chart visual representation of system throughput over time. The blue line indicates downlink throughput and the orange line indicates uplink throughput. The X-axis may be configured to display data over seconds, minutes, or hours, and the Y-axis is adjusted automatically based on average throughput. Hover over data points to display details.

Figure 78 SM Throughput Chart page

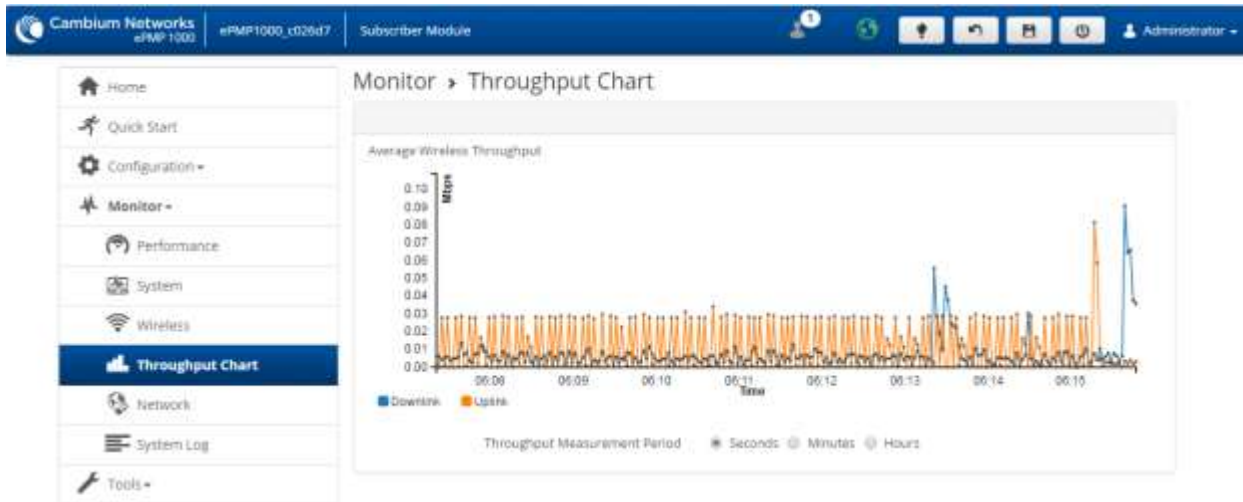

© 2016 Cambium Networks, All Rights Reserved | Version 3.1 | Support | Community Forum

Table 127 SM Throughput Chart page attributes

Attribute	Meaning
Throughput Measurement Period	Adjust the X-axis to display throughput intervals in seconds, minutes, or hours.

### SM Network page

Use the **SM Network** page to reference key information about the device network status.



Figure 79 SM Network page, Bridge Mode

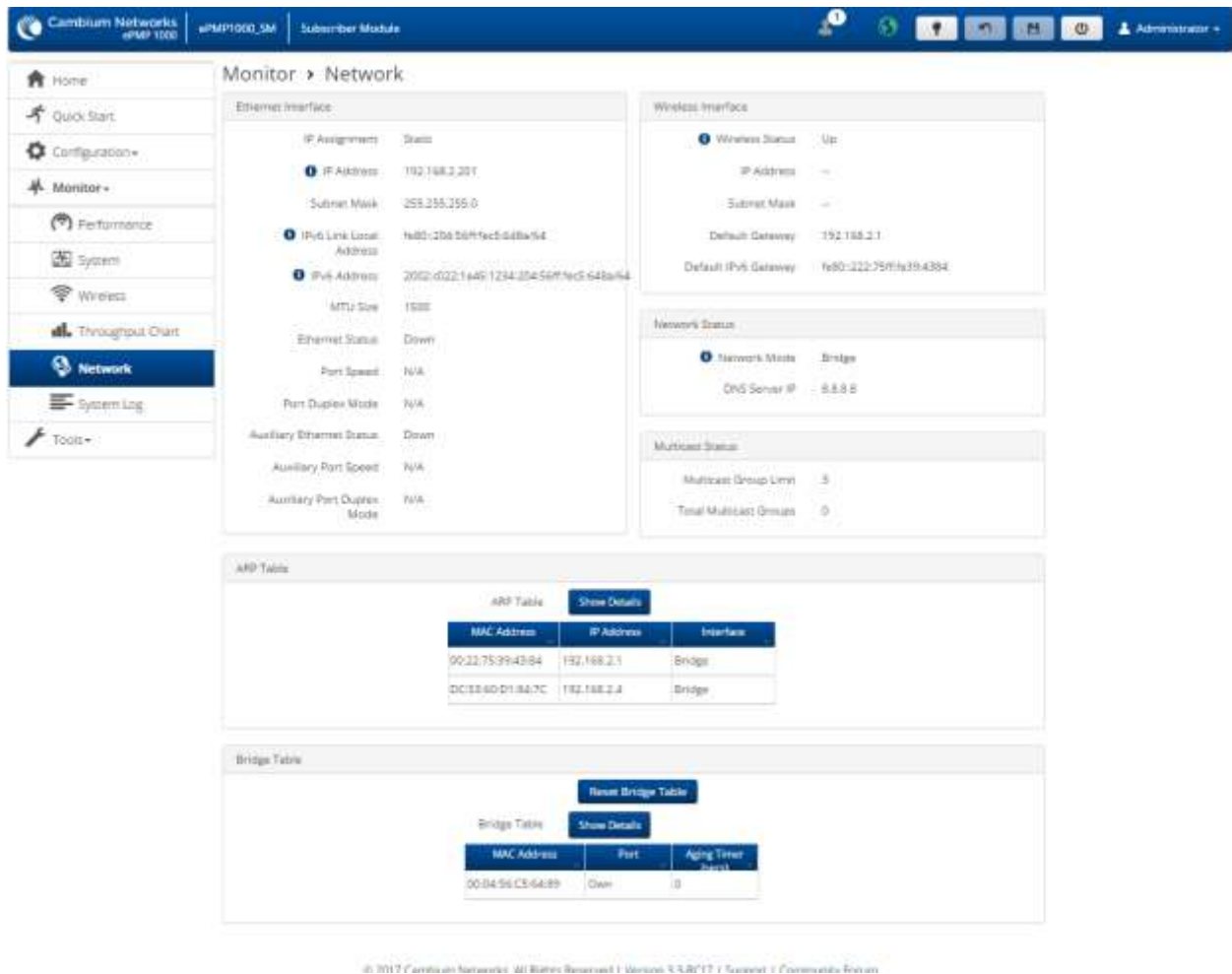

Table 128 SM Network page attributes, Bridge Mode

Attribute	Meaning
Ethernet Interface	
IP Address	The IP address for the device when the device is used in Bridge mode.
Subnet Mask	<b>The currently configured device IP subnet mask.</b>
IPv6 Link Local Address	<b>A link-local address is required for the IPv6-enabled interface (applications may rely on the link-local address even when there is no IPv6 routing). The IPv6 link-local address is comparable to the auto-configured IPv4 address 169.254.0.0/16.</b>
IPv6 Address	<b>The IPv6 address for device management.</b>
MTU Size	<b>The currently configured Maximum Transmission Unit for the AP's Ethernet (LAN) interface. Larger MTU configurations can enable the network to operate with greater efficiency, but in the case of retransmissions due to packet errors, efficiency is reduced since large packets must be resent in the event of an error.</b>

Attribute	Meaning
Ethernet Status	<p><b>Up:</b> The device Ethernet interface is functioning and passing data</p> <p><b>Down:</b> The device Ethernet interface has encountered an error disallowing full operation. Reset the device to reinitiate the Ethernet interface.</p>
Port Speed	The current speed of the SM's LAN port.
Port Duplex Mode	The current duplex mode of the SM's LAN port.
Auxiliary Ethernet Status	The current status of the SM's Auxiliary Ethernet Port.
Auxiliary Port Speed	The current operating speed of the SM's Auxiliary Ethernet Port.
Auxiliary Port Duplex Mode	The current operating duplex mode of the SM's Auxiliary Ethernet Port.
Wireless Status	
Wireless Interface	<p><b>Up:</b> The device wireless interface is functioning and passing data</p> <p><b>Down:</b> The device wireless interface has encountered an error disallowing full operation. Reset the device to reinitiate the wireless interface.</p>
IP address	The IP address for the wireless interface is displayed only when the SM is in NAT Mode.
Subnet Mask	The subnet for the wireless interface is displayed only when the SM is in NAT Mode.
Default Gateway	The current configured gateway for the bridge network of the SM.
Network Status	
Network Mode	<p><b>Bridge:</b> The SM acts as a switch, and packets are forwarded or filtered based on their MAC destination address.</p> <p><b>NAT:</b> The SM acts as a router, and packets are forwarded or filtered based on their IP header (source or destination) which can be grouped into subnets for finer granularity.</p> <p><b>Router:</b> The SM acts as a router and packets are forwarded or filtered based on their IP header (source or destination) using specific static routes and IP aliases configured by the operator.</p>
DNS Server IP	Represents the IP address of the DNS Server.
Multicast Status	
Multicast Group Limit	The maximum number of simultaneous multicast groups that will be allowed through the SM.
Total Multicast Groups	The current number of Multicast groups that have subscribed under this SM.
ARP Table	
MAC Address	MAC Address of the devices on the bridge.
IP Address	IP Address of the devices on the bridge.
Interface	Interface on which the SM identified the devices on.
Bridge Table	
MAC Address	MAC Address of the SM connected to the AP.

Attribute	Meaning
Port	The port to which the device is connected.
Aging Timer (secs)	Time set for the MAC addresses in the Bridge table.

Figure 80 SM Network page, NAT Mode

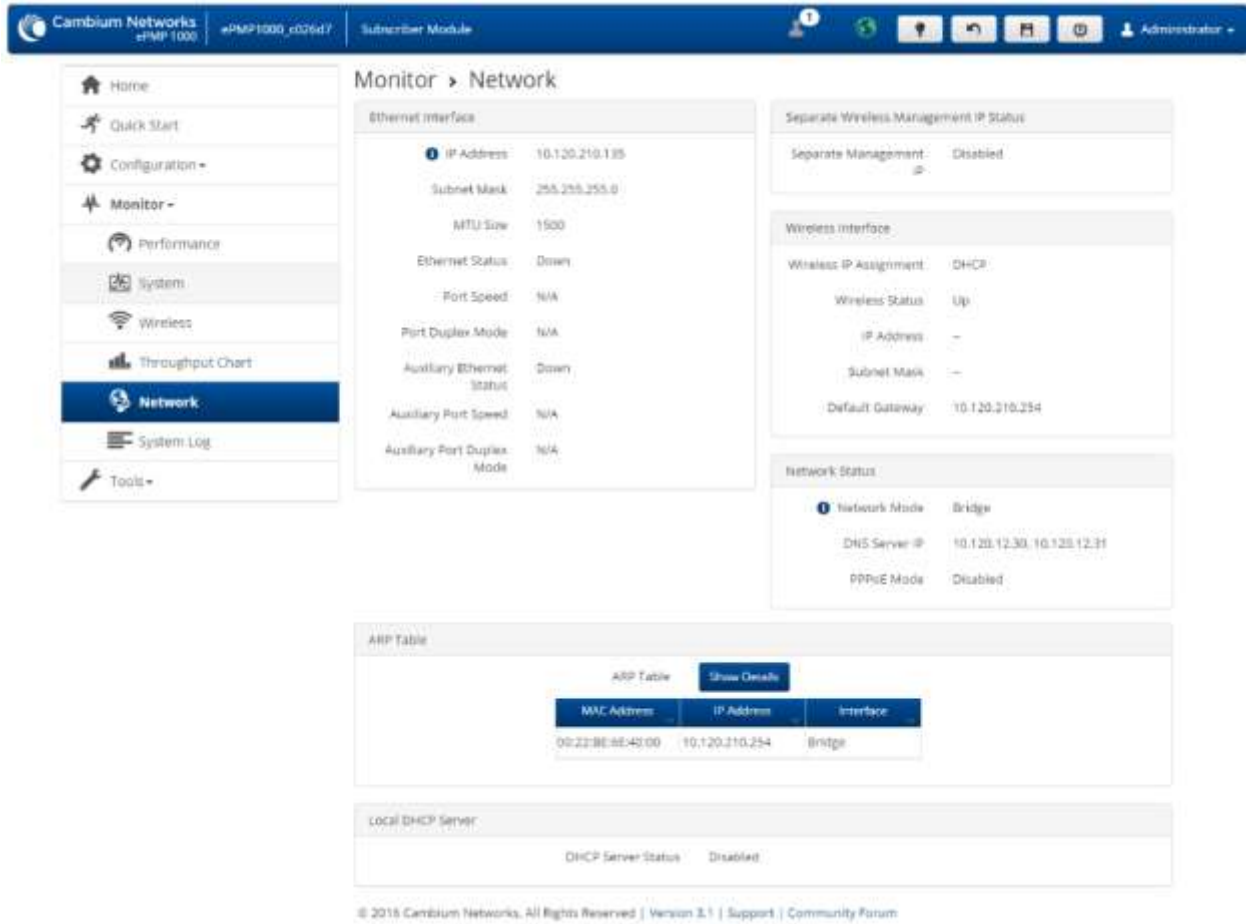

Table 129 SM Network page attributes, NAT mode

Attribute	Meaning
Ethernet Interface	
IP Address	The IP address for the subnet associated with the Ethernet interface when the device is used in NAT and Router modes.
Subnet Mask	The currently configured device IP subnet mask.
MTU Size	The currently configured Maximum Transmission Unit for the AP's Ethernet (LAN) interface. Larger MTU configurations can enable the network to operate with greater efficiency, but in the case of retransmissions due to packet errors, efficiency is reduced since large packets must be resent in the event of an error.

Attribute	Meaning
Ethernet Status	<p><b>Up:</b> The device Ethernet interface is functioning and passing data</p> <p><b>Down:</b> The device Ethernet interface has encountered an error disallowing full operation. Reset the device to reinitiate the Ethernet interface.</p>
Port Speed	The current speed of the SM's LAN port.
Port Duplex Mode	The current duplex mode of the SM's LAN port.
Auxiliary Ethernet Status	The current status of the SM's Auxiliary Ethernet Port.
Auxiliary Port Speed	The current operating speed of the SM's Auxiliary Ethernet Port.
Auxiliary Port Duplex Mode	The current operating duplex mode of the SM's Auxiliary Ethernet Port.
Separate Wireless Management IP	
Separate Management IP	<p>Disabled: <b>A separate wireless management interface is not available.</b></p> <p>Enabled: <b>A Separate Wireless Management IP has been configured and a management interface is available.</b></p>
IP Assignment	<p>Static: <b>Device management IP addressing is configured manually in fields IP Address, Subnet Mask, Gateway, Preferred DNS Server and Alternate DNS Server.</b></p> <p>DHCP: Device management IP addressing (IP address, subnet mask, gateway, and DNS server) is assigned via a network DHCP server, and parameters IP Address, Subnet Mask, Gateway, Preferred DNS Server and Alternate DNS Server are unused.</p>
IP Address	The IP address for the separate wireless management interface is displayed only when the <b>Separate Wireless Management IP</b> is enabled.
Subnet Mask	The subnet for the separate wireless management interface.
Gateway	The default gateway for the separate wireless management interface.
Wireless Status	
Wireless IP Assignment	<p>Static: <b>Device management IP addressing is configured manually in fields IP Address, Subnet Mask, Gateway, Preferred DNS Server and Alternate DNS Server.</b></p> <p>DHCP: Device management IP addressing (IP address, subnet mask, gateway, and DNS server) is assigned via a network DHCP server, and parameters IP Address, Subnet Mask, Gateway, Preferred DNS Server and Alternate DNS Server are unused.</p>
Wireless Status	<p><b>Up:</b> The device wireless interface is functioning and passing data</p> <p><b>Down:</b> The device wireless interface has encountered an error disallowing full operation. Reset the device to reinitiate the wireless interface.</p>
IP Address	The IP address for the wireless interface of the SM.
Subnet Mask	The subnet for the wireless interface of the SM.
Default Gateway	The default gateway for the wireless interface of the SM.
Network Status	

Attribute	Meaning
Network Mode	<p><b>Bridge:</b> The SM acts as a switch, and packets are forwarded or filtered based on their MAC destination address.</p> <p><b>NAT:</b> The SM acts as a router, and packets are forwarded or filtered based on their IP header (source or destination) which can be grouped into subnets for finer granularity.</p> <p><b>Router:</b> The SM acts as a router and packets are forwarded or filtered based on their IP header (source or destination) using specific static routes and IP aliases configured by the operator.</p>
DNS Server IP	Represents the IP address of the DNS Server.
PPPoE Mode	<p><b>Disabled:</b> <b>If this is left blank the STA will accept the first service option that comes back from the Access Concentrator specified below, if any. PPPoE is 'Disabled' by default.</b></p> <p><b>Enabled:</b> An optional entry is 'Enabled' to set a specific service name to connect to the PPPoE session. This is limited to 32 characters.</p>
DHCP Lease Time	Current configured time for which a DHCP IP address is leased. When the lease time expires, the DHCP client must renew IP addressing via DHCP request.
ARP Table	
MAC Address	MAC Address of the devices in the SM's routing table.
IP Address	IP Address of the devices in the SMs routing table.
Interface	Interface on which the SM identified the devices on.
Local DHCP Server	
DHCP Server Status	Indicates if the local DHCP server on the SM in NAT mode is Enabled/Disabled.
DHCP Server IP Start Address	The first IP address in the DHCP pool which will be issued to a DHCP client. Upon additional DHCP requests, the DHCP Start IP is incremented until Local DHCP End IP is reached.
DHCP Server IP End Address	The last/highest address IP address in the DHCP pool of addresses which is issued to a DHCP client.
DHCP Gateway IP Address	The gateway of the local DHCP server
DHCP DNS IP Address	DNS Server IP address which will be used to configure DHCP clients (if <b>Local DHCP Server</b> is set to <b>Enabled</b> under Configuration=>Network).
DHCP Static MAC to IP Configuration Table	
MAC Address	MAC address of clients that were statically assigned an IP address in the <b>DHCP Static MAC to IP Configuration</b> Table under Configuration > Network
IP Address	IP address of clients that were statically assigned an IP address in the <b>DHCP Static MAC to IP Configuration</b> Table under Configuration > Network
DHCP Assigned IP Address Table	
MAC Address	MAC address of clients that were assigned a IP address through DHCP from the Local DHCP Server

---

Attribute	Meaning
IP Address	IP address of clients that were assigned a IP address through DHCP from the Local DHCP Server
Device Name	Device Name of clients that were assigned a IP address through DHCP from the Local DHCP Server

---

Figure 81 SM Network page, Router Mode

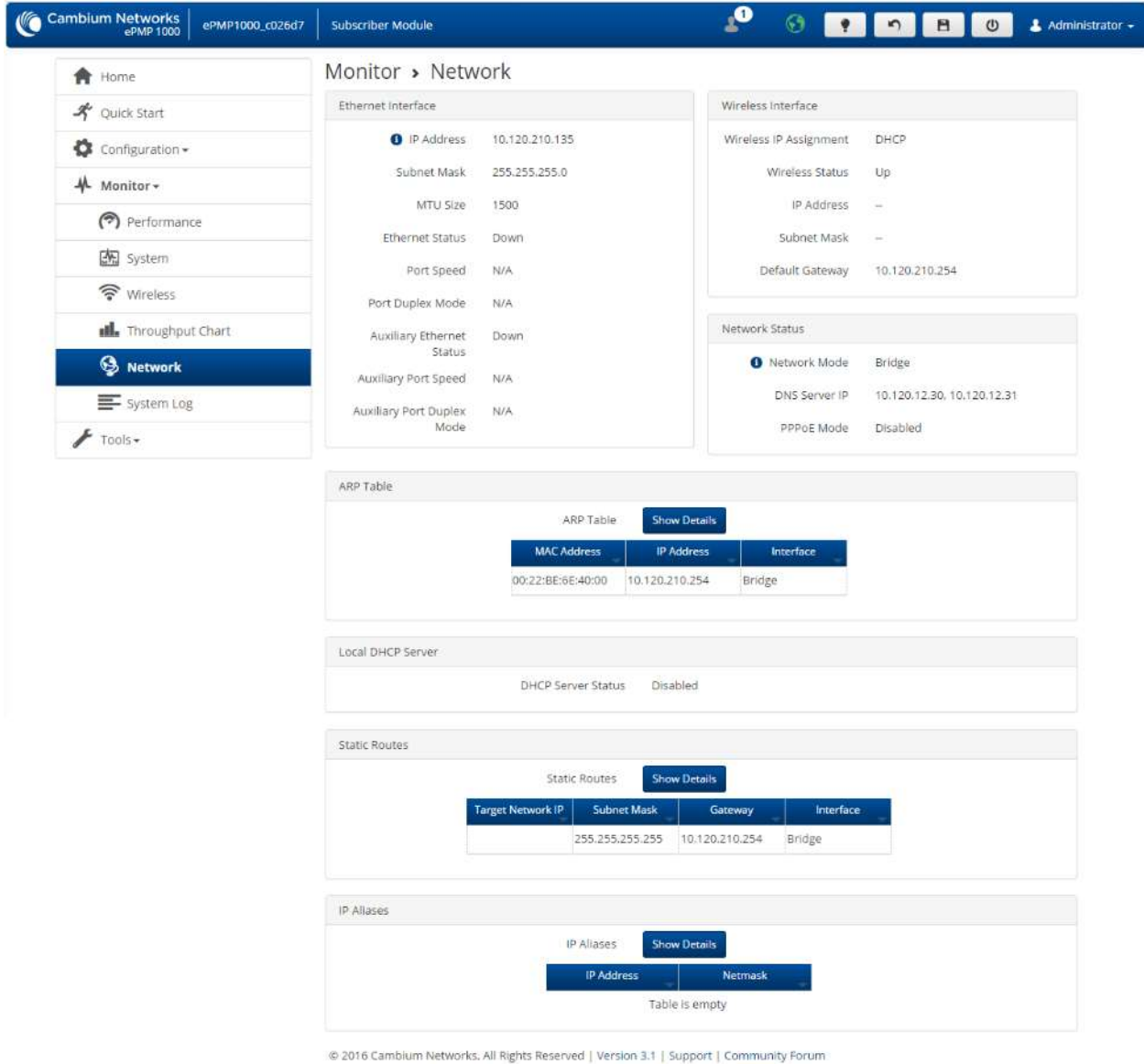

Table 130 SM Network page attributes, Router mode

Attribute	Meaning
Ethernet Interface	
IP Address	The IP address for the subnet associated with the Ethernet interface when the device is used in NAT and Router modes.
Subnet Mask	The currently configured device IP subnet mask.
MTU Size	The currently configured Maximum Transmission Unit for the AP's Ethernet (LAN) interface. Larger MTU configurations can enable the network to operate with greater efficiency, but in the case of retransmissions due to packet errors, efficiency is reduced since large packets must be resent in the event of an error.

Attribute	Meaning
Ethernet Status	<p><b>Up:</b> The device Ethernet interface is functioning and passing data</p> <p><b>Down:</b> The device Ethernet interface has encountered an error disallowing full operation. Reset the device to reinitiate the Ethernet interface.</p>
Port Speed	The current speed of the SM's LAN port.
Port Duplex Mode	The current duplex mode of the SM's LAN port.
Auxiliary Ethernet Status	The current status of the SM's Auxiliary Ethernet Port.
Auxiliary Port Speed	The current operating speed of the SM's Auxiliary Ethernet Port.
Auxiliary Port Duplex Mode	The current operating duplex mode of the SM's Auxiliary Ethernet Port.
Wireless Interface	
Wireless IP Assignment	<p>Static: <b>Device management IP addressing is configured manually in fields</b> IP Address, Subnet Mask, Gateway, Preferred DNS Server <b>and</b> Alternate DNS Server.</p> <p>DHCP: Device management IP addressing (IP address, subnet mask, gateway, and DNS server) is assigned via a network DHCP server, and parameters IP Address, Subnet Mask, Gateway, Preferred DNS Server and Alternate DNS Server are unused.</p>
Wireless IP Assignment	<p>Static: <b>Device management IP addressing is configured manually in fields</b> IP Address, Subnet Mask, Gateway, Preferred DNS Server <b>and</b> Alternate DNS Server.</p> <p>DHCP: <b>Device management IP addressing (IP address, subnet mask, gateway, and DNS server) is assigned via a network DHCP server, and parameters</b> IP Address, Subnet Mask, Gateway, Preferred DNS Server <b>and</b> Alternate DNS Server <b>are unused.</b></p>
IP Address	The IP address for the separate wireless management interface is displayed only when the <b>Separate Wireless Management IP</b> is enabled.
Subnet Mask	The subnet for the separate wireless management interface of the SM.
Default Gateway	The default gateway for the separate wireless management interface of the SM.
Network Status	
Network Mode	<p><b>Bridge:</b> The SM acts as a switch, and packets are forwarded or filtered based on their MAC destination address.</p> <p><b>NAT:</b> The SM acts as a router, and packets are forwarded or filtered based on their IP header (source or destination) which can be grouped into subnets for finer granularity.</p> <p><b>Router:</b> The SM acts as a router and packets are forwarded or filtered based on their IP header (source or destination) using specific static routes and IP aliases configured by the operator.</p>
DNS Server IP	Represents the IP address of the DNS Server.
PPPoE Mode	<p><b>Disabled:</b> <b>If this is left blank the STA will accept the first service option that comes back from the Access Concentrator specified below, if any. PPPoE is 'Disabled' by default.</b></p> <p><b>Enabled:</b> An optional entry is 'Enabled' to set a specific service name to connect to the PPPoE session. This is limited to 32 characters.</p>



Attribute	Meaning
DHCP Lease Time	Current configured time for which a DHCP IP address is leased. When the lease time expires, the DHCP client must renew IP addressing via DHCP request.
ARP Table	
MAC Address	MAC Address of the devices in the SM's routing table.
IP Address	IP Address of the devices in the SMs routing table.
Interface	Interface on which the SM identified the devices on.
Local DHCP Server	
DHCP Server Status	Indicates if the local DHCP server on the SM in NAT mode is Enabled/Disabled.
DHCP Server IP Start Address	The first IP address in the DHCP pool which will be issued to a DHCP client. Upon additional DHCP requests, the DHCP Start IP is incremented until Local DHCP End IP is reached.
DHCP Server IP End Address	The last/highest address IP address in the DHCP pool of addresses which is issued to a DHCP client.
DHCP Gateway IP Address	The gateway of the local DHCP server
DHCP DNS IP Address	DNS Server IP address which will be used to configure DHCP clients (if <b>Local DHCP Server</b> is set to <b>Enabled</b> under Configuration=>Network).
Static Routes	
<b>Target Network IP</b>	<b>Target subnet/network's IP address to which the SM should route the packets.</b>
<b>Subnet Mask</b>	<b>Subnet mask for the Target Network IP address.</b>
<b>Gateway</b>	<b>Gateway to which packets that match the Target Network IP Address and Subnet Mask are sent.</b>
<b>Interface</b>	<b>Interface to which the static route is active.</b>
IP Aliases	
<b>IP Address</b>	IP address for the configured IP alias.
<b>Subnet Mask</b>	Subnet mask for the configured IP alias.

### SM System Log page

Use the **SM System Log** page to view the device system log and to download the log file to the accessing PC or device.

**Figure 82** SM System Log page

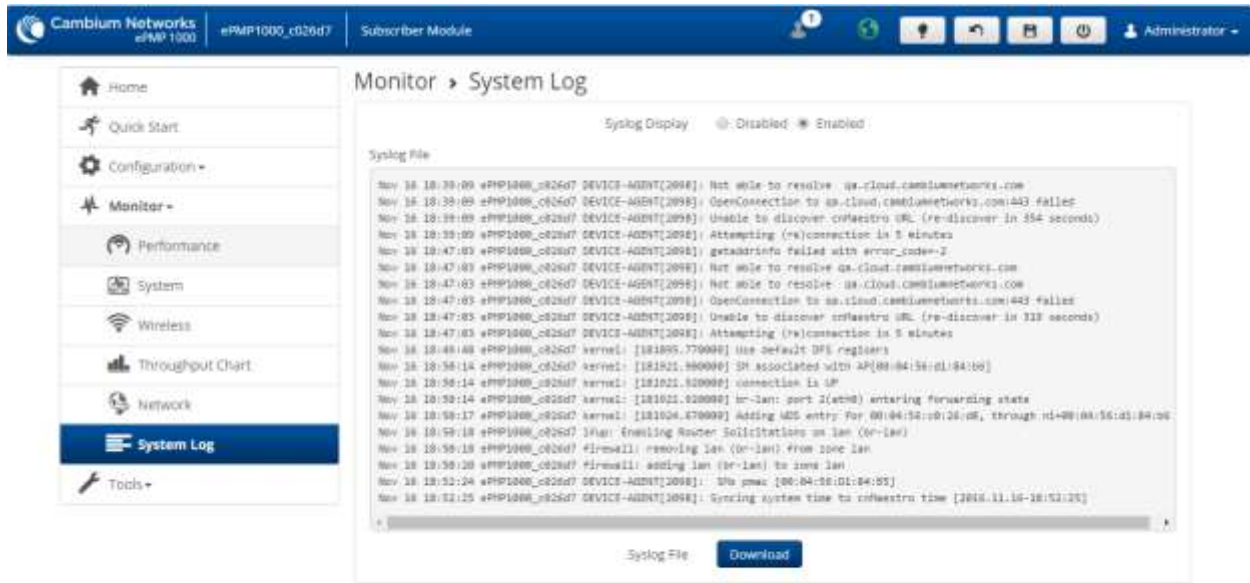

© 2018 Cambium Networks. All Rights Reserved | Version 3.1 | Support | Community Forum

**Table 131** SM System Log attributes

Attribute	Meaning
Syslog Display	<b>Enabled:</b> The system log file is displayed on the management GUI. <b>Disabled:</b> The system log file is hidden on the management GUI.
Syslog file	Use this button to download the full system log file to a connected PC or device.

## SM TOOLS MENU

The **SM Tools** menu provides several options for upgrading device software, configuration backup/restore, analyzing RF spectrum, testing device throughput, running ping and traceroute tests.

- SM Software Upgrade page on page 268
- SM Backup / Restore page on page 271
- SM eDetect page on page 273
- SM Spectrum Analyzer page on page 275
- SM eAlign page on page 277
- SM Wireless Link Test page on page 278
- SM Ping page on page 278
- SM Traceroute page on page 279

### SM Software Upgrade page

Use the **SM Software Upgrade** page to update the device radio software to take advantage of new software features and improvements.



**Caution**

Please read the Release Notes associated with each software release for special notices, feature updates, resolved software issues, and known software issues. The Release Notes may be accessed at the [Cambium Support Center](#).

**Figure 83** SM Software Upgrade page

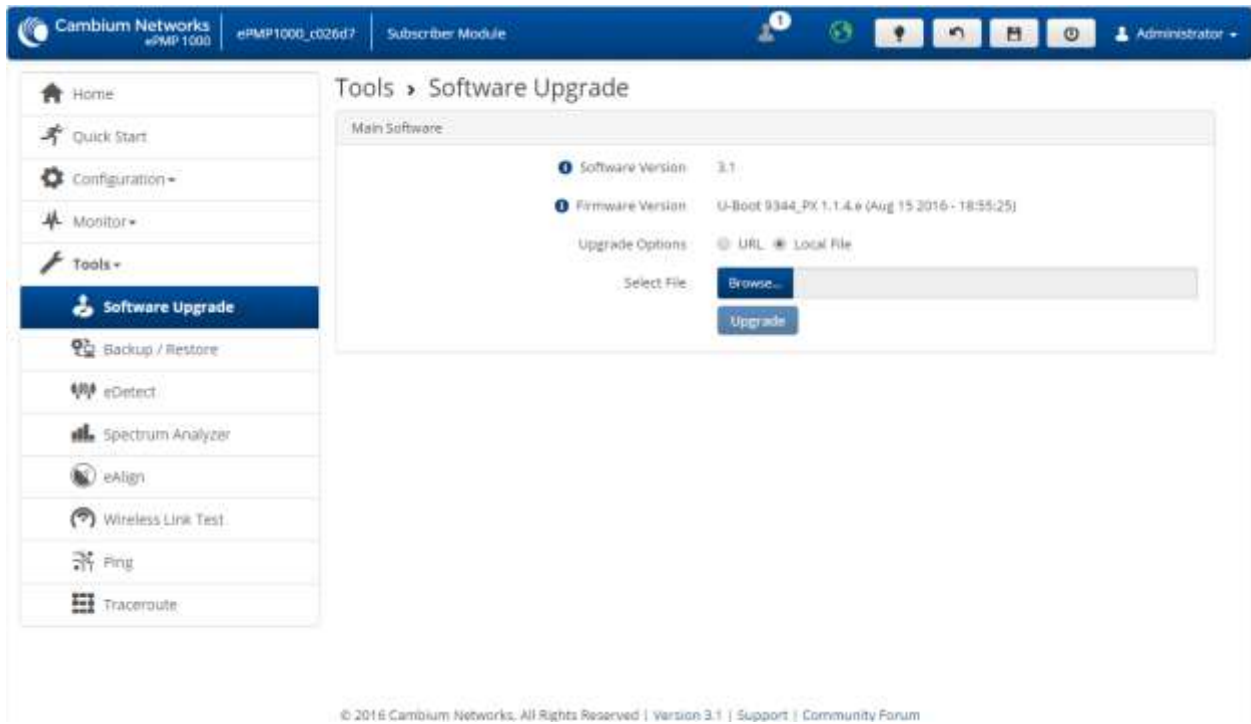

**Table 132** SM Software Upgrade attributes

Attribute	Meaning
Software Version	The current operating software version. ePMP boards that do not have an onboard GPS have one bank of flash memory which contains a version of software. The version of software last upgraded onto the Flash memory is present on this bank of flash memory. This software will be used by the SM when the SM is rebooted.
Firmware Version	Specifies the code used to boot the board.
Upgrade Options	<p><b>From URL:</b> A webserver may be used to retrieve software upgrade packages (downloaded to the device via the webserver). For example, if a webserver is running at IP address 192.168.2.1 and the software upgrade packages are located in the home directory, an operator may select option <b>From URL</b> and configure the <b>Software Upgrade Source Info</b> field to <b>http://192.168.2.1/&lt;software_upgrade_package&gt;</b></p> <p><b>From Local File:</b> Click Browse to select the local file containing the software upgrade package</p>

---

Attribute	Meaning
Select File	Click <b>Browse</b> to select a local file (located on the device accessing the web management interface) for upgrading the device software.

---

To upgrade the device software, follow this procedure:

**Procedure:**

- 1 Download the software upgrade packages from <https://support.cambiumnetworks.com/files/epmp>
- 2 Clear the cache of the accessing browser
- 3 On the device GUI, navigate to **Tools => Software Upgrade**
- 4 Select the **SW Upgrade Option** which represents the location of your software upgrade packages
- 5 Based on the configuration of **SW Upgrade Option**, enter either the **Software Upgrade Source Info** or click the **Browse** button and locate the software package
- 6 Click Upgrade
- 7 When the upgrade is completed successfully, click the **Reset** icon

## SM Backup / Restore page

Use the **SM Backup / Restore** page to perform the following functions:

- Back up the configuration in either text (.json) format or binary (.bin) format.
- Restore the configuration of using a configuration file that was previously backed up.
- Reset the device to its factory default configuration. For more factory defaulting methods, see:
  - [Using the device external reset button](#) on page 304
  - [Resetting ePMP to factory defaults by power cycling](#) on page 306.



Figure 84 SM Backup / Restore page

The screenshot shows the web interface for the Cambium Networks ePMP 1000 Subscriber Module. The top navigation bar includes the Cambium Networks logo, the device ID 'ePMP1000\_c026d7', the 'Subscriber Module' title, and a user profile for 'Administrator'. A left sidebar contains navigation links: Home, Quick Start, Configuration, Monitor, Tools, Software Upgrade, Backup / Restore (highlighted), eDetect, Spectrum Analyzer, eAlign, Wireless Link Test, Ping, and Traceroute. The main content area is titled 'Tools > Backup / Restore' and contains three sections:

- Backup Configuration:** Features radio buttons for 'Text (Editable)' (selected) and 'Binary (Secured)', with a 'Download' button.
- Restore Configuration:** Features a 'Select File' label, a 'Browse...' button, and an 'Upload' button.
- Factory Default Configuration:** Features four rows of radio buttons:
  - 'Reset Via Power Sequence' with 'Disabled' and 'Enabled' options.
  - 'Retain Passwords' with 'Disabled' and 'Enabled' options.
  - 'Keep Passwords' with a checkbox.
  - 'Reset to Factory Defaults' with a checkbox.A 'Reset' button is located at the bottom of this section.

© 2016 Cambium Networks. All Rights Reserved | Version 3.1 | Support | Community Forum

**Table 133** SM Backup / Restore attributes

Attribute	Meaning
Backup Configuration	
Configuration File Format	<p><b>Text (Editable):</b> Choosing this option will download the configuration file in the <code>.json</code> format, and can be viewed and/or edited using a standard text editor.</p> <p><b>Binary (Secured):</b> Choosing this option will download the configuration file in the <code>.bin</code> format, and cannot be viewed and/or edited using an editor. Use this format for a secure backup.</p>
Restore Configuration	
Select File	Click <b>Browse</b> to select a local file (located on the device accessing the web management interface) for restoring the device configuration.
Factory Default Configuration	
Reset Via Power Sequence	<p><b>Enabled:</b> When Enabled, it is possible to reset the radio's configuration to factory defaults using the power cycle sequence explained under <a href="#">Resetting ePMP to factory defaults by power cycling</a> on page 306.</p> <p><b>Disabled:</b> When Disabled, it is not possible to factory default the radio's configuration using the power cycle sequence.</p>
Retain Passwords	<p>When set to <b>Enabled</b>, then after a factory default of the radio for any reason, the passwords used for GUI and CLI access will not be defaulted and will remain unchanged. The default value of this field is <b>Disabled</b>.</p> <hr/> <p> Caution</p> <p>If the passwords cannot be retrieved after the factory default, access to the radio will be lost/unrecoverable. This feature prevents unauthorized users from gaining access to the radio for any reason, including theft.</p>
Keep Passwords	When the <b>Keep Passwords</b> checkbox is selected, the passwords used for GUI and CLI access will not be defaulted and will remain unchanged. This is one-time option, and it does not apply to factory default procedures completed by power cycling (Reset Via Power Sequence).
Reset to Factory Defaults	<p>Use this button to reset the device to its factory default configuration.</p> <p> Caution</p> <p>A reset to factory default configuration resets all device parameters. With the SMs in default configuration it may not be able to register to an AP configured for your network.</p>



### SM eDetect page

The **eDetect** tool (not available in ePTP Slave mode) is used to measure the 802.11 interference at the ePMP radio or system when run from the AP, on the current operating channel. When the tool is run, the ePMP device processes all frames received from devices not connected to the ePMP system and collects the interfering frame’s information such as MAC Address, RSSI, and MCS. Use the SM **eDetect** page to collect information about interferers locally at the SM to display on the SM’s GUI.

Figure 85 SM eDetect page

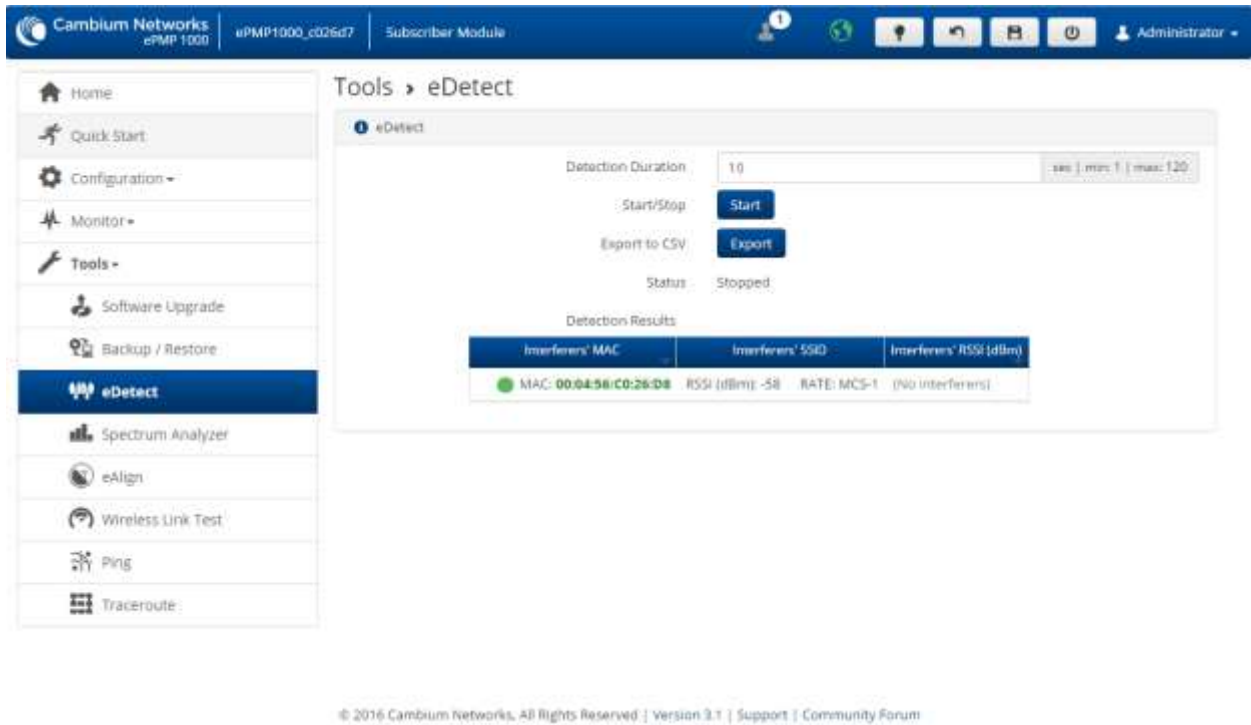



Table 134 SM eDetect attributes

Attribute	Meaning
eDetect	
Detection Duration	Configure the duration for which the SM scans for interferers.  Caution During the scanning period, the SM must be connected to the AP and passing user traffic, and there cannot be any outage (unlike running a Spectrum Analyzer). There may be a negligible degradation in the SM’s throughput.
Start/Stop	Use to start or stop the interference detection.
Export to CSV	Choose this option to export the detection results to .csv format.
Status	Current status of the Interference Detection tool.
Detection Results	Use the <b>Detection Results</b> table to monitor interferers at the SM and their key RF parameters.

---

Attribute	Meaning
Device Instant Health	<p>This is an indicator of the device's health in terms of channel conditions in the presence of interferer(s).</p> <p><b>Green:</b> Indicates that the channel is relatively clean and has good C/I levels (&gt;25dB). The interference level is low.</p> <p><b>Yellow:</b> Indicates that the channel has moderate or intermittent interference (C/I between 10dB and 25dB).</p> <p><b>Red:</b> Indicates that the channel has high interference and poor C/I levels (&lt;10dB).</p>
Device MAC	The MAC address of the SM's wireless interface.
Device RSSI (dBm)	The Received Signal Strength Indicator, which is a measurement of the power level being received by the device's antenna.
Device MCS	Modulation and Coding Scheme – indicates the modulation mode used for a radio's receiver side, based on radio conditions (MCS 1-7, 9-15).
Interferers' MAC	The MAC address of the interferer's wireless interface.
Interferers' RSSI (dBm)	The Received Signal Strength Indicator, which is a measurement of the interferer's power level being received by the device's antenna.
Interferers' MCS	Modulation and Coding Scheme – indicates the modulation mode used by the interferer, based on radio conditions (ex: MCS 1--15).

---

-

## SM Spectrum Analyzer page

Use the **SM Spectrum Analyzer** page to configure SM spectrum analyzer parameters and to download the spectrum analyzer tool.

To download the spectrum analyzer tool, the AP **Device Mode** must be set to **Spectrum Analyzer**.

Java Runtime Environment is required to run the AP spectrum analyzer.

---



Caution

Conducting spectrum analysis causes the SM to enter scan mode and the SM drops all RF connections.

Vary the days and times when you analyze the spectrum in an area. The RF environment can change throughout the day or throughout the week.

### To conduct a spectrum analysis, follow these steps:

Required Software:

- Java Run-time Environment (JRE)

### Procedure:

- 1 On the SM GUI, navigate to **Configure => System**
- 2 Configure Device mode to Spectrum Analyzer
- 3 Click the **Save** button
- 4 Click the **Reset** button
- 5 Login to the SM and navigate to **Tools => Spectrum Analyzer**.
- 6 Click Download Spectrum Analyzer Tool
- 7 Locate the folder to which the spectrum analyzer tool was saved, and double-click on file `csa.jnlp` to launch the tool
- 8 If a security warning window is presented, tick the checkbox next to *"I accept the risk and want to run this application"*
- 9 In the security warning window, click **Run**  
The spectrum analyzer interface is displayed
- 10 Click **Range** to configure the range of frequencies to scan.

11 Click **Start Scan** to begin scanning

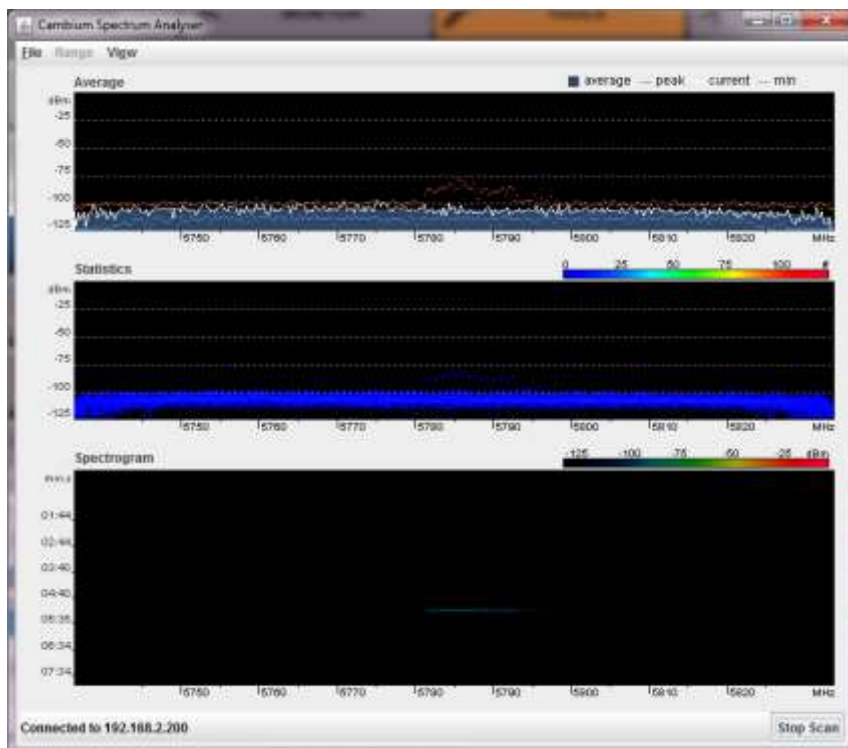

Display of the average, peak, current, and minimum power levels for the configured range

Statistical display of the number of times each frequency in the range was scanned

Spectrogram display of the energy levels detected throughout the configured range, over time

When scanning is complete, follow these steps to return the device to SM operation:

**Procedure:**

- 1 In the spectrum analyzer application, click **Stop Scan**
- 2 Close the spectrum analyzer application by clicking **File => Exit**
- 3 On the SM GUI, navigate to **Configure => System**
- 4 Configure Device Mode to SM
- 5 Click the **Save** button
- 6 Click the **Reset** button

### SM eAlign page

Use the eAlign page to aid with link alignment. A valid link to an AP is required for eAlign to provide meaningful measurements.

Figure 86 SM eAlign page



Table 135 SM eAlign attributes

Attribute	Meaning
Operating Frequency	The current frequency at which the SM is operating.
Registered AP SSID	The SSID of the AP to which the SM is registered.
Current RSSI	Current RSSI value measured on the uplink by the SM’s receiver.
Peak RSSI	Peak RSSI value measured by the SM’s receiver from the time the user navigated to the eAlign page.
Reset Measurements	Click this button to reset all current measurements.

### SM Wireless Link Test page

Use the **SM Wireless Link Test** page to conduct a simple test of SM wireless throughput to the AP to which it is registered. This allows you to determine the throughput that can be expected on a particular link without having to use external tools.

**Figure 87** SM Wireless Link Test page

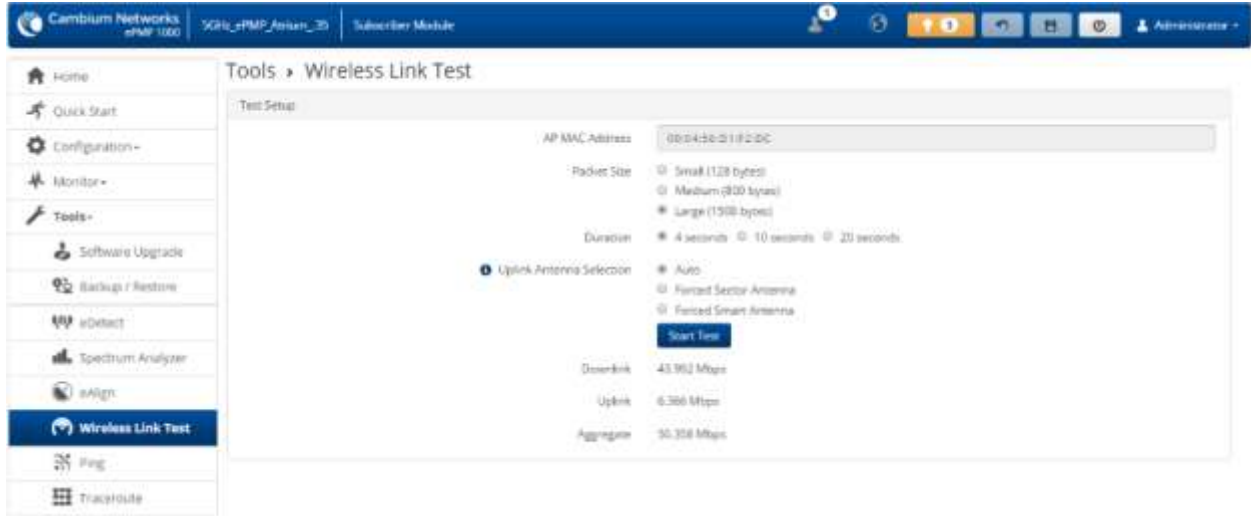

**Table 136** SM Wireless Link Test attributes

Attribute	Meaning
Test Setup	
<b>AP MAC Address</b>	<b>This is not an editable field. It is automatically populated with the wireless MAC address of the AP to which the SM is registered.</b>
<b>Packet Size</b>	<b>Choose the Packet Size to use for the throughput test.</b>
<b>Duration</b>	<b>Choose the time duration in seconds to use for the throughput test.</b>
<b>Uplink Antenna Selection</b>	Uplink Antenna Selection specifies the antenna to be used in the uplink for the wireless link test. The antenna cannot be forced if it is already configured to Forced Sector Antenna or Forced Smart Antenna in the AP.
<b>Downlink</b>	<b>This field indicates the result of the throughput test on the downlink, in Mbps.</b>
<b>Uplink</b>	<b>This field indicates the result of the throughput test on the uplink, in Mbps.</b>
<b>Aggregate</b>	<b>This field indicates the result of the aggregate throughput on the link, in Mbps. Displayed only when Downlink/Uplink Ratio is set to 75/25, 50/50 or 30/70.</b>

### SM Ping page

Use the **SM Ping** page to conduct a simple test of SM IP connectivity to other devices which are reachable from the network. If no ping response is received or if “Destination Host Unreachable” is reported, the target may be down, there may be no route back to the SM, or there may be a failure in the network hardware (i.e. DNS server failure).

Figure 88 SM Ping page

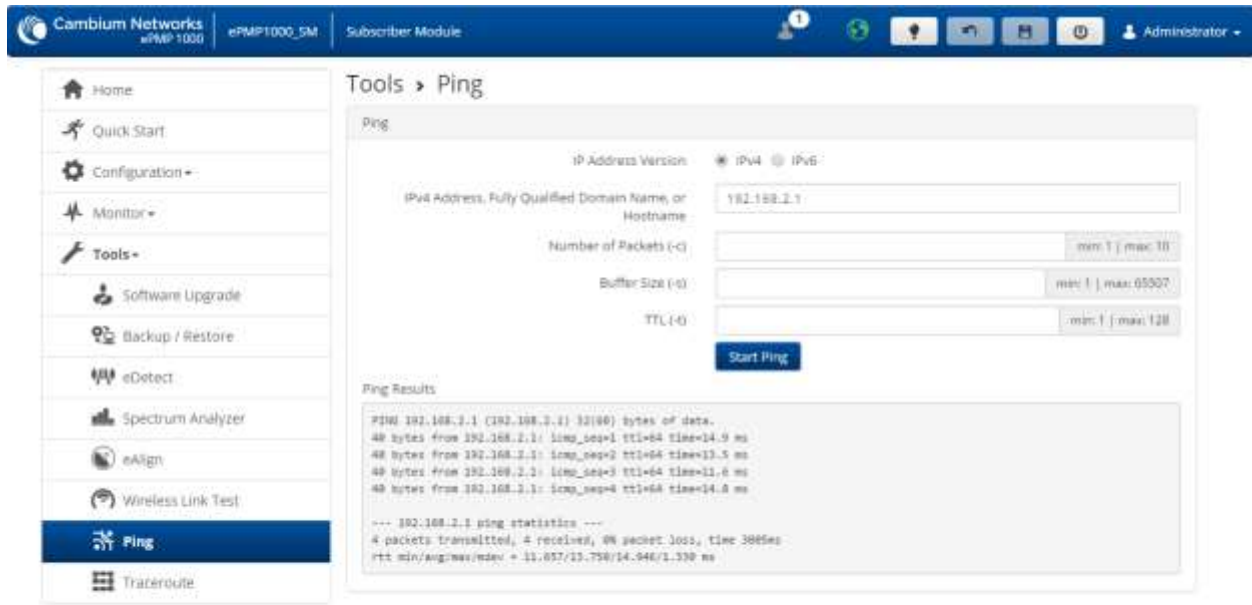

© 2017 Cambium Networks. All Rights Reserved | Version 3.3-RC17 | Support | Community Forum

Table 137 SM Ping attributes

Attribute	Meaning
Ping	
IP Address Version	IPv4: The ping test is conducted via IPv4 protocol. IPv6: The ping test is conducted via IPv6 protocol.
IP Address	Enter the IP address of the ping target.
Number of packets (-c)	Enter the total number of ping requests to send to the target.
Buffer size (-s)	Enter the number of data bytes to be sent.
TTL (-t)	Set the IP Time-To-Live (TTL) for multicast packets. This flag applies if the ping target is a multicast address.
Ping Results	Displays the ping test results.

**SM Traceroute page**

Use the **SM Traceroute** page to display the route (path) and associated diagnostics for IP connectivity between the SM and the destination specified.

Figure 89 SM Traceroute page

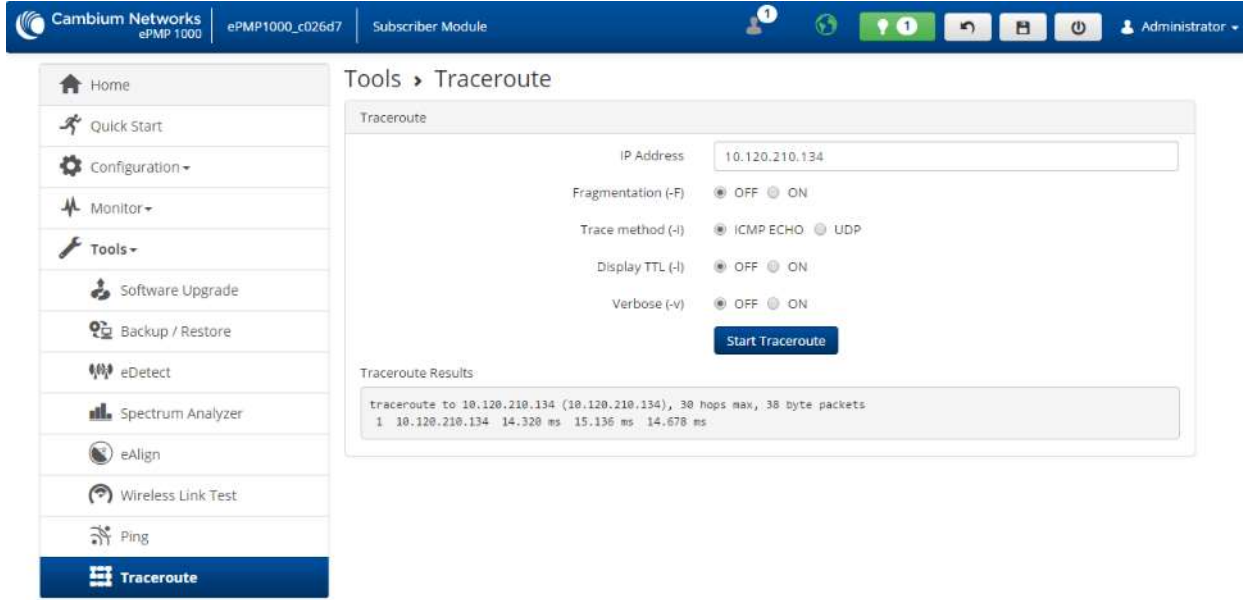

© 2016 Cambium Networks. All Rights Reserved | Version 3.1 | Support | Community Forum

Table 138 SM Traceroute attributes

Attribute	Meaning
Traceroute	
<b>IP Address</b>	<b>Enter the IP address of the target of the traceroute diagnostic.</b>
<b>Fragmentation (-F)</b>	<b>ON: Allow source and target to fragment probe packets.</b> <b>OFF: Do not fragment probe packets (on source or target).</b>
<b>Trace method (-I)</b>	<b>ICMP ECHO: Use ICMP ECHO for traceroute probes.</b> <b>UDP: Use UDP for traceroute probes.</b>
<b>Display TTL (-I)</b>	<b>ON: Display TTL values for each hop on the route.</b> <b>OFF: Suppress display of TTL values for each hop on the route.</b>
<b>Verbose (-v)</b>	<b>ON: ICMP packets other than TIME_EXCEEDED and UNREACHABLE are displayed in the output.</b> <b>OFF: Suppress display of extraneous ICMP messaging.</b>
<b>Traceroute Results</b>	<b>Displays the results of the traceroute diagnostics.</b>



## Radius Server

### INSTALLING FREE-RADIUS ON UBUNTU 12.04 LTS

To install the Radius server on Ubuntu 12.04 LTS, follow these instructions:

1. On the free-radius web page <http://freeradius.org>, download the latest package (currently 3.1), either from the main page or the download page.
2. Extract the archive file by using the command line as shown below:
  - To extract a tar.bz2 file, use the command (note the j option)  
`tar -jxvf freeradius-server-x.x.x.tar.bz2`
  - To extract a tar.gz file, use the command (note the z option)  
`tar -zxvf freeradius-server-x.x.x.tar.gz`

3. Once the files are extracted to a folder (cd freeradius-server-x.x.x), execute these commands:

```
sudo apt-get install libssl-dev
sudo apt-get install libtalloc-dev
./configure
make
make install
```

### CONFIGURING FREE-RADIUS SERVER

To configure Free-Radius server, follow these steps:



Note

IP address or subnet of the client must be configured in the clients.conf file.

Ex. – For the examples listed in the document, the subnet of the external machine is 172.22.121.0 or 192.168.0.0.

1. For testing from external machines, edit `/usr/local/etc/raddb/clients.conf` and add an entry.  
For example:

```
client 172.22.121.0/24 {
    ipaddr = 172.22.121.0
    netmask = 24
    secret = cambium
    proto = *
    shortname = epmp1
}
client 127.0.0.0/24 {
    ipaddr = 172.22.121.0
    netmask = 24
    secret = cambium
    proto = *
    shortname = epmp1
}
client 192.168.0.0/16 {
    ipaddr = 192.168.0.0
    netmask = 16
    secret = cambium
    proto = *
}
```

2. To add *EAP-TTLS Username* and *EAP-TTLS Password*, edit `usr/local/etc/raddb/user`.

For example put this string at the end of file:

```
cambium-SubscriberModule Cleartext-Password := "cambium",
```

where *cambium-SubscriberModule* - EAP-TTLS Username and "cambium" - EAP-TTLS Password.

3. To configure free-radius key and certificate, edit */usr/local/etc/raddb/mods-available/eap* and add your certificates to folder */usr/local/etc/raddb/certs*.

Locate a string such as *default\_eap\_type*, *private\_key\_file*, *certificate\_file* in *eap* file and change the value to:

```
default_eap_type = ttls  
private_key_password = *** - according to your certificate  
private_key_file = ${certdir}/***.key  
certificate_file = ${certdir}/***.crt
```

Under the *ttls* section, change the following:

```
copy_request_to_tunnel=yes  
use_tunnel_reply=yes
```



Note

Once these steps are performed, free-radius in debug mode can be initiated: *\$ radiusd -X*.

## CONFIGURING RADIUS PARAMETERS ON AP

Figure 90 AP Radius configuration

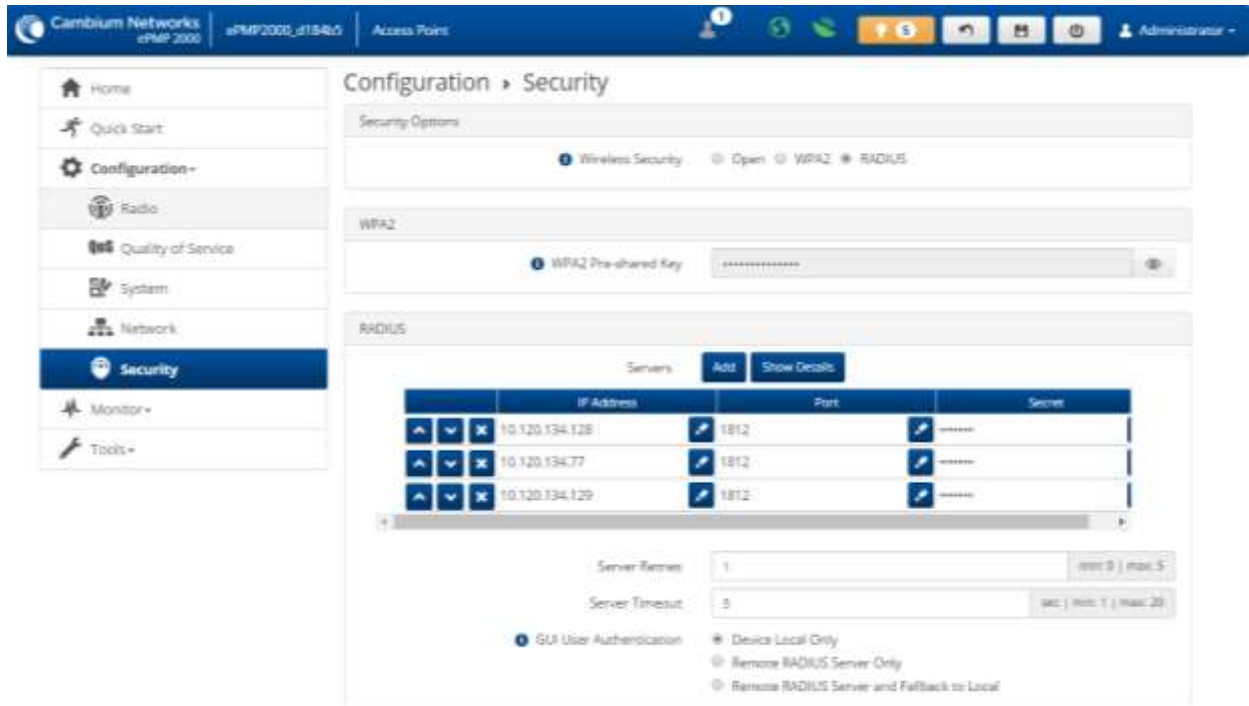

To configure Radius parameters on the AP, follow these steps:

1. Open the GUI and login as *admin*.
2. Navigate to **Configure -> Security -> Wireless Security**.
3. Change the value to **RADIUS**.
4. Add IP Address of your RADIUS Server in the *Radius Servers* table.
5. Also configure *Port* (you may use default 1812) and *Secret* which has to be the same as in **clients.conf** file.
6. Click **Save**, to keep the changes.

## CONFIGURING RADIUS PARAMETERS ON SM

Figure 91 SM Radius configuration

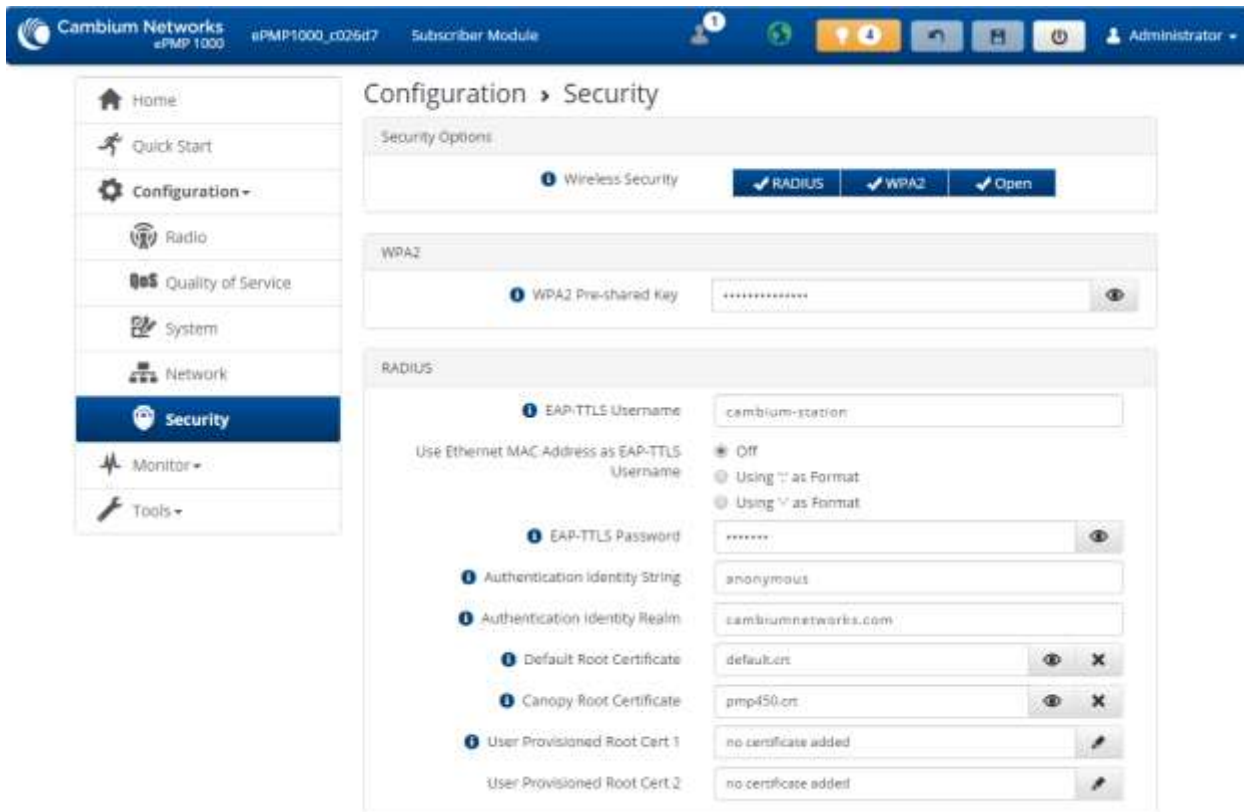

To configure Radius parameters on SM, follow these steps:

1. Select **Wireless Security** as **RADIUS**.
2. Configure **EAP-TTLS Username** and **EAP-TTLS Password**, as configured in file **users**.
3. Choose the **Default Root Certificate**.
4. Click **Save**, to keep the changes.

## CONFIGURING MIR PROFILES

To configure the MIR profiles, follow these steps:

1. Create a dictionary file with the MIR Profiles:

```
# touch dictionary.cambium
```

2. Edit *dictionary.cambium* according to the instructions that you can find under */usr/local/etc/raddb* directory in file **dictionary**.

For example:

```
ATTRIBUTE Cambium-ePMP-ULMIR 110 integer #Max Burst Uplink Rate
ATTRIBUTE Cambium-ePMP-DLMIR 110 integer #Max Burst Downlink Rate

VENDOR Cambium 17713

#
# Cambium vendor-specific attributes.
#

BEGIN-VENDOR Cambium

ATTRIBUTE Cambium-ePMP-ULMIR 26integer #Max Burst Uplink Rate
ATTRIBUTE Cambium-ePMP-DLMIR 27integer #Max Burst Downlink Rate
```

3. Create link on your dictionary:

```
#ln -s dictionary.cambium dictionary.local
```

4. To configure MIR profiles, edit *usr/local/etc/raddb/users* and add profiles for each client below users configuration :

```
SubscriberModule33 Cleartext-Password := "cambium33"
Cambium-ePMP-ULMIR = 100,
Cambium-ePMP-DLMIR = 100
```

```
SubscriberModule34 Cleartext-Password := "cambium34"
    Cambium-ePMP-ULMIR = 110,
    Cambium-ePMP-DLMIR = 110
```

```
SubscriberModule35 Cleartext-Password := "cambium35"
    Cambium-ePMP-ULMIR = 120,
    Cambium-ePMP-DLMIR = 120
```

Example scenarios of MIR and RADIUS configurations are described in [Table 136](#).

**Table 139** Example scenarios of MIR and RADIUS configurations

Scenario	Description
<b>No MIR control via Radius</b>	In a scenario where Radius is not in use for MIR profiles, the GUI will be the only place to configure MIR profiles and apply them to the corresponding SMs. Configure the MIR profiles in the <b>Configure =&gt; Quality of Service</b> menu option on the AP GUI and apply the corresponding profile # in the SM under the same menu option on SM.
<b>MIR control using only Radius</b>	In the case where only the Radius server is being used for MIR profiles, all settings in the GUI will be overridden for any SM being managed by the Radius Server. In this case, create the MIR profile with Subscriber Module usernames and password on the Radius server. At the time of registration, the AP uses the radius information and applies the corresponding profile to the SM. In the wireless statistics page ( => <b>Wireless Status</b> ), the MIR profile # from the Radius server along with UL and DL rate information will show up. In this scenario the QOS profiles in the AP GUI are irrelevant. Multiple SMs across multiple APs can then be managed via Radius.
<b>Hybrid control using both Radius and MIR profile on the AP GUI</b>	The system also supports a hybrid mode where Radius and the GUI QOS profiles can be used simultaneously as long as the same SM does not have a profile # associated from the AP & Radius. In case where it is redundant, Radius server setting will override the MIR profile settings from the GUI.

## CREATING CERTIFICATE FOR RADIUS SERVER AND SM DEVICE

### Create your own certification center

#### Creating a CA private key

1. Create a root (self-signed) certificate from our private certificate. Go to the directory where the database is stored for our certificates and start generating.

2. Create a private key CA (my own Certificate Authority). RSA key length of 2048 bits encryption algorithm 3DES. File name with a key - cambium-ca.key

```
openssl genrsa -des3 -out cambium-ca.key 2048
Generating RSA private key, 2048 bit long modulus
..... + + +
..... + + +
e is 65537 (0x10001)
Enter pass phrase for cambium.key:
Verifying - Enter pass phrase for cambium-ca.key:
```

3. While creating the private key, you must enter a passphrase, which will be closed by key (and confirm it). Content key, can viewed from the following command:

```
openssl rsa -noout -text -in cambium-ca.key
```

In this case you must enter the private key again.

## Creating a CA certificate

1. Generate a self-signed certificate CA:

```
openssl req -new -x509 -days 3650 -key cambium-ca.key -out cambium-ca.crt
```

2. Enter pass phrase for cambium.key:

You are asked to enter information that will be incorporated into your certificate request.

What you enter is called a *Distinguished Name* or a *DN*. There are quite a few fields of which you can leave some blank. For some fields there is a default value,

If you enter '.', field is left blank.

-----

Country Name (2 letter country code)

State or Province Name (full name)

Locality Name (Ex. City)

Organization Name (Ex, Cambium Networks)

Organizational Unit Name (Ex. Cambium)

Common Name (Ex. cambium root CA)

Email Address (Ex. [admin@cambium.com](mailto:admin@cambium.com))

3. Generating the certificate, you must enter a passphrase, with a closed key CA, and then - to fill in the required fields (company name, email, etc.); the most important of these is the Common Name - the unique name of the certification center.

In this case, as the Common name was chosen "cambium root CA", view the resulting certificate command as shown below:

```
openssl x509 -noout -text -in cambium-ca.crt
```

As a result, we see:

Certificate:

Data:

Version: 3 (0x2)

Serial Number:

ea: 30:7 b: 69 : a2: 13:0 c: 70

Signature Algorithm: md5WithRSAEncryption

Issuer: C = UA, ST = Euro, L = Kiev, O = Cambium Networks, OU = Cambium,

CN = cambium root CA / email address = [admin@cambium.com](mailto:admin@cambium.com)

# Issued to (by us, that is self-signed)

Validity

Not Before: Dec 9, 2005 11:34:29 GMT

Not After: Dec 7, 2015 11:34:29 GMT

# Validity of the certificate

Subject: C = UA, ST = Euro, L = Kiev, O = Cambium Networks, OU = Cambium,

CN = cambium root CA / email address = [admin@cambium.com](mailto:admin@cambium.com)

# Filter (field) certificate

Subject Public Key Info:

Public Key Algorithm: rsaEncryption

RSA Public Key: (2048 bit)

Modulus (2048 bit):

00: c0: ff: 50 : fd: a8: eb: 07:9 b: 17 : d1: a9: e2: a5: dc:

59: a7: 97:28:9 f: bc: a4: 01:16:45:37: f5: 8d: ca: 1e:

12: ca: 25:02:8 a: cf: ee: ae: 35:59: ed: 57:89: c7: 2b:

```

17:9 f: 8b: de: 60 : db: e5: eb: b3: de: 09:30:3 b: a9: 68:
40: f7: f8: 84 : f4: 6c: b2: 24:3 d: ed: 45 : a3: 8a: 66:99:
40: a9: 53:0 c: 75 : e3: df: f3: ef: 20:0 c: a6: 3f: f2: dd:
e9: 1c: f5: d1: c1: 32:4 c: 44 : fd: c1: a2: d9: e6: e0: dc:
04:0 c: f8: dd: 9e: 31 : aa: 9d: 60 : b0: 84 : d2: e0: b7: a5:
eb: 82:31:4 f: 71 : c4: ee: ab: 5c: 8e: ef: 8c: a1: 1a: 2a:
62: e9: e9: 36 : ff: 12 : b9: c9: ac: 0e: 4d: ac: 08:97:87:
d2: 30:2 f: 41 : a1: 9e: ef: 8b: bf: c6: cf: 66:70:02: ab:
2d: b0: 9c: 56 : b8: 13 : e8: 92:59: f5: d9: 33 : d7: 33:6 a:
7c: cb: 9b: 92 : ee: 4b: 22:32:73:59:70:3 f: b1: f6: 1b:
67:1 d: 28 : eb: bb: 4b: 5e: 61:95:43:78: d5: 3b: db: e1:
37 : f1: ec: 0d: db: 50:65:22: cb: f4: f9: b8: 2a: c6: 1f:
2b: e9: f8: 64:03:4 f: 36 : dc: 72:8 e: be: 3d: 12:8 a: ca:
8b: 95

```

Exponent: 65537 (0x10001)

X509v3 extensions:

X509v3 Subject Key Identifier:

4C: 80 : F5: 82:4 C: A4: 52 : DF: 9E: 0C: 0D: 64:74:68:1 E: 45 : F6: C1: C7: 68

X509v3 Authority Key Identifier:

keyid: 4C: 80 : F5: 82:4 C: A4: 52 : DF: 9E: 0C: 0D: 64:74:68:1 E: 45 : F6: C1: C7: 68

DirName : / C = UA / ST = Euro / L = Kiev / O = Cambium Networks / OU = Cambium /

CN = cambium root CA / emailAddress = admin@cambium.com

serial: EA: 30:7 B: 69 : A2: 13:0 C: 70

X509v3 Basic Constraints:

CA: TUAE

Signature Algorithm: md5WithRSAEncryption

```

57 : db: 0d: 2b: 27 : eb: 0a: 97:7 f: b1: 37 : b3: d1: d7: 14 : a6: 80:66:
3d: 7c: 00:4 a: 45:1 f: 7c: 2b: 5e: 30 : b2: 72:74:9 f: 6d: 33:82: f7:
f7: de: 54 : a9: 2b: e7: ea: 1b: 93 : bd: cc: 74:4 f: 11 : ed: 94:0 b: b9:
b2: 1f: b1: 86:6 e: c6: 48:71:48:9 b: 2b: 0a: 36 : f3: ab: d6: f9: 75 :
c9: 0d: 1b: e9: 2c: 85:04: fc: 17:9 a: 94 : b9: 14:0 d: 15 : d1: 1e: 8b:
bb: 9e: 91 : ca: 40:8 c: d8: ef: dd: 4a: 75 : d0: b9: 62 : d4: ee: 1b: e5:
b5: 7e: fa: f1: 5d: 62 : d1: 78 : b0: 34:04: bb: 60:37:8 a: a8: 74:88:
f6: 94:3 b: c8: fb: c0: 98 : f4: 94 : e9: d5: 53:8 e: 31 : e6: 25:56: c3:
84:7 c: 46 : b9: 09:5 f: e3: 43 : a8: 57 : c9: 3a: d9: 3d: a7: b0: 41 : db:
ea: ca: 60:28:0 b: a3: f0: 0b: e6: d6: c0: 5b: 15:0 c: f8: 19:36:26:
d3: 2a: 8d: c9: 67 : fe: 04:6 f: e9: bf: f9: 55 : de: 2c: 92:04:81:6 f:
43 : d5: 94:25: af: 83 : b8: 01:22: c8: 1a: 7e: 2e: a9: 10 : b0: e5: 35 :
a7: 17 : bf: 65 : a1: 31:55:85: ba: 10:24:71:03:3 b: d6: 71 : a4: ad:
48:28:46:8 f: 7e: e6: b3: 8c: 37:97:4 f: 36:05:8 c: f6: d1: 40 : a8:
c4: 58:9 b: 28

```

4. Now copy the certificate and key of the CA in a public place, for example, in `/etc/ssl/cambium`:

```

mkdir /etc /ssl /cambium
cp cambium-ca. * /etc/ssl/cambium/

```

## Issuance of certificates

### Script certificate generation



- Download (from the Cambium support web-site) the script **sign\_cert.sh**. It allows you to create server/user.

- Edit the following lines:

```

ROOTCA = "cambium"
root CA name - Filename of the root certificate (without the suffix '-
ca')
O = "Cambium Networks" - Name of the organization
C = "UA" - country
ST = "Euro" - staff
L = "Kiev" - city
OU = "Cambium" - unit
EMAIL = email@cambium.com - email
BITS = 2048 - Size of the generated key in bits
CLIENT_DAYS = 730 - Client certificate validity period in days
SERVER_DAYS = 1461 - Server certificate validity period in days

```

Lines related to the country, city, department, email, etc must be fixed (though not necessarily, this is default values that can be changed in the process of creating the certificate). Variables related to the terms of validity of the certificate can be left without changes.

## Creating a server certificate (for RADIUS)

1. Create a server certificate (option `server_cert`), file name (and certificate) `radius.cambium.com`.

```

. / sign_cert.sh server_cert radius.cambium.com
create certificate key: radius.cambium.com.key

```

Generating RSA private key, 2048 bit long modulus

```

..... + + +
..... + + +
e is 65537 (0x10001)

```

# First generates key, it is necessary enter the password which will close the key

```

Enter pass phrase for radius.cambium.com.key:
Verifying - Enter pass phrase for radius.cambium.com.key:
decrypt certificate key: radius.cambium.com.crt
Enter pass phrase for radius.cambium.com.key:
writing RSA key

```

# Create a certificate request

```

Create certificate request: radius.cambium.com.csr

```

```

. / sign_cert.sh radius.cambium.com server_cert
You are about to be asked to enter information that will be incorporated
into your certificate request.
What you are about to enter is what is called a Distinguished Name or a
DN.
There are quite a few fields but you can leave some blank
For some fields there will be a default value,
If you enter '.', the field will be left blank.

```

2. Then you must specify the fields you want, like for the root certificate. Default values have already populated in square brackets. To use them simply click ENTER.

- Your Country Name (2 letter country code):

- State or Province Name (full name):
- Locality Name (Ex.- city)
- Organization Name (Ex.- Cambium Networks):
- Organizational Unit Name (Ex.- Cambium):
- Common Name (Ex.- radius.cambium.com):
- Email Address (Ex.- email@cambium.com):

#### # Sign the certificate request

```
sign certificate by CA: radius.cambium.com.crt
sign ca is: cambium-ca
CA signing: radius.cambium.com.csr -> radius.cambium.com.crt:
Using configuration from ca.config
```

3. Since we sign new created certificate with root certificate, we must enter the password which we used to close root certificate of our center CA

```
Enter pass phrase for. /.. / cambium-ca.key:
Check that the request matches the signature
Signature ok
The Subject's Distinguished Name is as follows
countryName: PRINTABLE: 'UA'
stateOrProvinceName: PRINTABLE: 'Euro'
localityName: PRINTABLE: 'Kiev'
organizationName: PRINTABLE: 'Cambium Networks'
organizationalUnitName: PRINTABLE: 'Cambium'
commonName: T61STRING: 'radius.cambium.com'
emailAddress: IA5STRING: 'email@cambium.com'
Certificate is to be certified until Dec 25 12:05:18 2013 GMT (730 days)
Everything is OK, completing work
Server certificate is created.
```

## VENDOR-SPECIFIC ATTRIBUTE (VSA) REFERENCE

The ePMP RADIUS Dictionary file defines all of the ePMP Vendor-specific Attributes that can be utilized in the radio network. This file must be stored on the RADIUS server to be able to provision RADIUS users and clients with VSA configurations or to control administrator login credentials and privileges.

**Table 140** ePMP VSA additional details

Attribute Name	Number <sup>1</sup>	Bridge Mode	NAT / Router Mode	GUI Analogue	Valid Values Usage Examples
Cambium-ePMP-VLIGVID	26.17713.21	Applicable	Not Applicable	Data VLAN ID	1-4094
Cambium-ePMP-VLMGVID	26.17713.22	Applicable	Applicable	AP or SM in Bridge Mode: <b>Management VLAN ID</b>	1-4094
				SM in NAT or Router Mode with Separate	

<sup>1</sup> 26 connotes Vendor-specific Attribute, per RFC 2865

				<p>Management IP Enabled:  <b>VLAN (Data) -&gt; VLAN ID</b></p> <p>SM in NAT or Router Mode with Separate Management IP Disabled:  <b>VLAN (Management + Data) -&gt; VLAN ID</b></p>	
Cambium-ePMP-ULMIR	26.17713.26	Applicable	Applicable	<b>Uplink Maximum Information Rate (MIR)</b>	100-1000000 (kbps)
Cambium-ePMP-DLMIR	26.17713.27	Applicable	Applicable	<b>Downlink Maximum Information Rate (MIR)</b>	100-1000000 (kbps)
Cambium-ePMP-UserLevel	26.17713.50	Applicable	Applicable	<b>Section Account Management</b>	<p>2-5</p> <p>2 – Installer (permission to read and write parameters applicable to unit installation and monitoring)</p> <p>3 – Administrator (full read and write permission)</p> <p>4 – User (permission only to access pertinent information for support purposes)</p> <p>5 – Readonly (permission to only view the Monitor page)</p>
Cambium-ePMP-STAPRI	26.17713.51	Applicable	Applicable	<b>Subscriber Module Priority</b>	<p>0-2</p> <p>0 – Normal</p> <p>1 – High</p> <p>2 - Low</p>
Cambium-ePMP-VLANMEMSET	26.17713.52	Applicable	Not Applicable	<b>Membership VLANs table</b>	<p>1-4094 (for each VLAN ID in the range)</p> <p>Example:                      To set a VLAN Membership range from VLAN ID 256 (Begin) to VLAN ID 300 (End), in the RADIUS users file set:</p>

					<p>Cambium-ePMP-VLANMEMSET = "16777516"</p> <p>This decimal value in hex is 0x0100012C. In this case, the first two bytes represent the beginning of the range, 0x0100 (256 in decimal) and the last two bytes represent the end of the range, 0x012C (300 in decimal).</p>
Cambium-ePMP-VLManagPVID	26.17713.53	Applicable	Applicable	<p>AP or SM in Bridge Mode: <b>Management VLAN Priority</b></p>	0-7
				<p>SM in NAT or Router Mode with Separate Management IP Enabled: <b>VLAN (Data) -&gt; VLAN Priority</b></p> <p>SM in NAT or Router Mode with Separate Management IP Disabled: <b>VLAN (Management + Data) -&gt; VLAN Priority</b></p>	
Cambium-ePMP-VLDataPVID	26.17713.54	Applicable	Not Applicable	<b>Data VLAN Priority</b>	0-7
Cambium-ePMP-VLMG2VID	26.17713.55	Not Applicable	Applicable	<b>Separate Management VLAN -&gt; VLAN ID</b>	1-4094
Cambium-ePMP-VLMG2PVID	26.17713.56	Not Applicable	Applicable	<b>Separate Management VLAN -&gt; VLAN Priority</b>	0-7
Cambium-ePMP-VLMultiCastVID	26.17713.57	Applicable	Not Applicable	<b>Multicast VLAN ID</b>	1-4094

<p>Cambium-ePMP-VLMAPPING</p>	<p>26.17713.58</p>	<p>Applicable</p>	<p>Not Applicable</p>	<p><b>VLAN Mapping table</b></p>	<p>1-4094 (for each VLAN ID in the range)</p> <p>Example: To map C-VLAN 23 to S-VLAN 400, in the RADIUS users file set: Cambium-ePMP-VLMAPPING = "1507728" This decimal value in hex is 0x00170190. In this case, the first two bytes represent the C-VLAN value 0x0017 (23 in decimal) and the last two bytes represent the S-VLAN value 0x0190 (400 in decimal).</p>
-------------------------------	--------------------	-------------------	-----------------------	----------------------------------	--

## Operation and Troubleshooting

This chapter provides instructions for operators of ePMP networks. The following topics are described:

- **General Planning for Troubleshooting** on page **295**
- **Upgrading device software** on page **297**
- **Testing hardware** on page **300**
- **Troubleshooting the radio link** on page **302**
- **Using the device external reset button** on page **304**
- **Resetting ePMP to factory defaults by power cycling** on page **306**

## General Planning for Troubleshooting

Effective troubleshooting depends in part on measures that you take before you experience trouble in your network. Cambium recommends the following measures for each site:

### Procedure:

- 1 Identify troubleshooting tools that are available at your site (such as a protocol analyzer).
- 2 Identify commands and other sources that can capture baseline data for the site. These may include:
  - Ping
  - tracert or traceroute
  - Throughput Test results
  - Throughput data
  - Configure GUI page captures
  - Monitor GUI page captures
  - Session logs
- 3 Start a log for the site, including:
  - Operating procedures
  - Site-specific configuration records
  - Network topology
  - Software releases
  - Types of hardware deployed
  - Site-specific troubleshooting process
  - Escalation procedures
  - GPS latitude/longitude of each network element
  -

## GENERAL FAULT ISOLATION PROCESS

Effective troubleshooting also requires an effective fault isolation methodology that includes

- Attempting to isolate the problem to the level of a system, subsystem, or link, such as
  - AP to SM
  - AP to CMM
  - AP to GPS
  - CMM to GPS
  - power
- Researching System Logs of the involved equipment.
- Answering the questions listed in the following section.
- Reversing the last previous corrective attempt before proceeding to the next.
- Performing only one corrective attempt at a time.

## QUESTIONS TO HELP ISOLATE THE PROBLEM

When a problem occurs, attempt to answer the following questions:

- 1 What is the history of the problem?
    - Have we changed something recently?
    - Have we seen other symptoms before this?
  - 2 How wide-spread is the symptom?
    - Is the problem on only a single SM? (If so, focus on that SM.)
    - Is the problem on multiple SMs? If so:
      - is the problem on one AP in the cluster? (If so, focus on that AP)
      - is the problem on multiple, but not all, APs in the cluster? (If so, focus on those APs)
      - is the problem on all APs in the cluster? (If so, focus on the CMM and the GPS signal.)
  - 3 Based on data in the System Log
    - Is intermittent connectivity indicated? (If so, verify your configuration, power level, CINR, cables and connections, and the speed duplex of both ends of the link).
    - Does the problem correlate to loss-of-sync events?
  - 4 Are connections made via *shielded* cables?
  - 5 Does the GPS antenna have an *unobstructed* view of the entire horizon?
-



## Upgrading device software

To take advantage of new features and software improvements for the ePMP system, monitor the Cambium Networks PMP Software website: <https://support.cambiumnetworks.com/files/epmp>

To upgrade the device software (AP or SM), follow this:

### Procedure:

- 1 When upgrading multiple v1.0.3 integrated devices, ensure that the browser cache is cleared at the beginning of the upgrade process.
- 2 Log in to the device GUI via the management IP
- 3 Navigate to page Tools, Software Upgrade

- 4 Under the **Main Software** section, set the **Upgrade Option** to **URL** to pull the software file from a network software server or select **Local File** to upload a file from the accessing device. If **URL** is selected, enter the server IP address, Server Port, and File path.

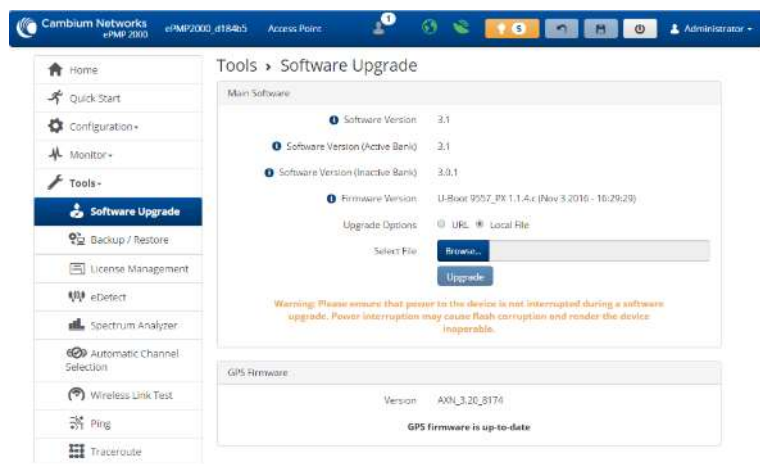

© 2016 Cambium Networks. All Rights Reserved | Version 3.1 | Support | Community Forum

- 5 If **Local File** is selected, click **Browse** to launch the file selection dialogue
- 6 Click Upgrade



Caution

Do not power off the unit in the middle of an upgrade process.

- 7 Once the software upgrade is complete, click the **Reset** icon.

## Upgrading on-board GPS chip firmware

To upgrade the GPS Synchronized ePMP radio's on-board GPS chip, follow this:

### Procedure:

- 1 When upgrading multiple v1.0.3 (or later) integrated devices, ensure that the browser cache is cleared at the beginning of the upgrade process.
- 2 Log in to the device GUI via the management IP
- 3 Navigate to page Tools, Software Upgrade
- 4 Under the section **GPS Firmware**, set the **Upgrade Options** to **URL** to pull the software file from a network software server or select **Local File** to upload a file from the accessing device.



#### Note

Use the same package that is used to upgrade the device's software. The new GPS firmware is part of the software upgrade packages.

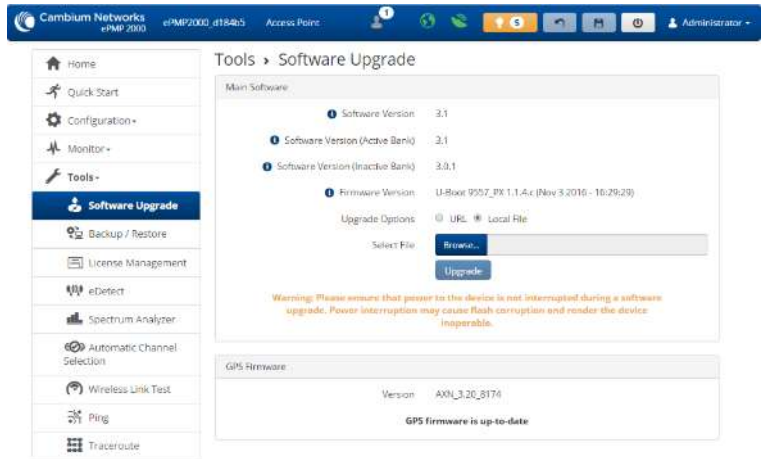

© 2016 Cambium Networks. All Rights Reserved | Version 3.1 | Support | Community Forum

- 5 If **Local File** is selected, click **Browse** to launch the file selection dialogue and click **Upgrade**.



#### Caution

Do not power off the unit in the middle of an upgrade process.

- 7 Once the software upgrade is complete, click the **Reset** icon.



#### Caution

In case of a locked GPS device the upgrade typically has a "GPS Firmware Version" as "Not Available"(although not always). The user must attempt the upgrade anyway. It is however likely to fail with a "GPS general communication error" displayed in the notification icon. If this occurs the user must power-cycle (not just reboot) the radio and attempt the upgrade again.

## GPS CHIP AND SOFTWARE REFERENCE

	ePMP 1000 (1st Generation)	ePMP 1000 (2nd Generation)	ePMP 2000
<b>GPS Chip Type</b>	GPS only	GPS + GLONASS	GPS + GLONASS
<b>Default GPS Firmware</b>	AXN_1.51_2801	AXN_3.20_8174	AXN_3.20_8174
<b>Potential Issues (With Default Firmware Installed)</b>	GPS chip locked, resulting in loss of sync and no display of firmware version or visible/tracked satellites	Occasional sync loss following low number of tracked satellites for customers in APAC and Russia regions	Occasional sync loss following low number of tracked satellites for customers in APAC and Russia regions
<b>Current GPS Firmware</b>	AXN_1.51_2838	AXN_5.1._8174	AXN_5.1._8174
<b>Corresponding ePMP Software Release</b>	2.1	3.5.1	3.5.1
<b>Known issues (With Current GPS Firmware)</b>	None	None	None

## Testing hardware

This section describes how to test the hardware when it fails on startup or during operation.

Before testing hardware, confirm that all outdoor cables, that is those that connect the AP or SM to equipment inside the building, are of the supported type, as defined in [Ethernet cabling](#) on page 95

### CHECKING THE POWER SUPPLY LED

When the power supply is connected to the main power supply, the expected LED behavior is:

- The Power (green) LED illuminates steadily.

If the expected LED operation does not occur, or if a fault is suspected in the hardware, check the LED states and choose the correct test procedure:

- [Power LED is off](#) on page 300
- [Ethernet LED is off](#) on page 300

### POWER LED IS OFF

**Meaning:** Either the power supply is not receiving power from the AC/DC outlet, or there is a wiring fault in the unit.

**Action:** Remove the AP/SM cable from the PSU and observe the effect on the Power LED. If the Power LED does not illuminate, confirm that the mains power supply is working, for example, check the plug. If the power supply is working, report a suspected power supply fault to Cambium Networks.

### ETHERNET LED IS OFF

**Meaning:** There is no Ethernet traffic between the AP/SM and power supply.

**Action:** The fault may be in the LAN or AP/SM cable:

- Remove the LAN cable from the power supply, examine it and confirm it is not faulty.
- If the PC connection is working, remove the AP/SM cable from the power supply, examine it, and check that the wiring to pins 1&2 and 3&6 is correct and not crossed.

### ***Test Ethernet packet errors reported by AP/SM***

Log into the AP or SM and click **Monitor, Performance**. Click **Reset System Counters** at the bottom of the page and wait until **LAN RX – Total Packet Counter** has reached 1 million. If the counter does not increment or increments too slowly, because for example the ePMP system is newly installed and there is no offered Ethernet traffic, then abandon this procedure and consider using the procedure **Test ping packet loss** on page 301.

Check the **LAN RX – Error Packet Counter** statistic. The test has passed if this is less than 10.

### ***Test Ethernet packet errors reported by managed switch or router***

If the AP/SM is connected to a managed Ethernet switch or router, it may be possible to monitor the error rate of Ethernet packets. Please refer to the user guide of the managed network equipment. The test has passed if the rate of packet errors reported by the managed Ethernet switch or router is less than 10 in 1 million packets.

### ***Test ping packet loss***

Using a computer, it is possible to generate and monitor packets lost between the power supply and the AP/SM. This can be achieved by executing the Command Prompt application which is supplied as standard with Windows and Mac operating systems.



Caution

This procedure disrupts network traffic carried by the AP or SM under test.

#### **Procedure:**

1. Ensure that the IP address of the computer is configured appropriately for connection to the AP or SM under test, and does not conflict with other devices connected to the network.
2. If the power supply is connected to an Ethernet switch or router then connect the computer to a spare port, if available.
3. If it is not possible to connect the computer to a spare port of an Ethernet switch or router, then the power supply must be disconnected from the network in order to execute this test:
  - Disconnect the power supply from the network.
  - Connect the computer directly to the LAN port of the power supply.
4. On the computer, open the Command Prompt application.
5. Send 1000 ping packets of length 1500 bytes. The process will take 1000 seconds, which is approximately 17 minutes.

If the computer is running a Windows operating system, this is achieved by typing (for an IPv6 address, use the ping6 command):

```
ping -n 1000 -l 1500 <ipaddress>
```

where <ipaddress> is the IP address of the AP or SM under test.

If the computer is running a MAC operating system, this is achieved by typing:

```
ping -c 1000 -s 1492 <ipaddress>
```

where <ipaddress> is the IP address of the AP/SM under test.

6. Record how many Ping packets are lost. This is reported by Command Prompt on completion of the test.

The test has passed if the number of lost packets is less than 2.

## Troubleshooting the radio link

This section describes how to test the link when there is no radio communication, when it is unreliable, or when the data throughput rate is too low. It may be necessary to test both the AP and the SM.

### MODULE HAS LOST OR DOES NOT ESTABLISH RADIO CONNECTIVITY

If there is no wireless activity, follow this:

#### Procedure:

- 1 Check that the AP and SMs are configured with the same **Frequency Carrier**. Also, if operating in a region where DFS is required, ensure that the SM's **Frequency Carrier List** contains the frequencies configured in the AP's **DFS Alternate Frequency Carrier 1** and **DFS Alternate Frequency Carrier 2** fields.
- 2 Check that the **Channel Bandwidth** is configured the same at the AP and at the SM
- 3 On the AP, verify that the **Max Range** setting is configured to a distance slightly greater than the distance between the AP and the furthest SM that must register to the AP.
- 4 Check that the AP's **Synchronization Source** is configured properly based on the network configuration.
- 5 Verify the authentication settings on the AP and SM. If **Authentication Type** is set to **WPA2**, verify that the **Pre-shared Key** matches between the AP and the SM **Preferred AP List**
- 6 Check that the software at each end of the link is the same version.
- 7 Check that the desired AP's SSID is configured in the SM **Preferred AP List**.
- 8 On the SM, check the **DL RSSI** and **DL CINR** values. Verify that for the SM installed distance, that the values are consistent with the values reported by the LINKPlanner tool.
- 9 Check Tx Power on the AP and SM
- 10 Check that the link is not obstructed or the AP/SM misaligned.
- 11 Check the DFS status page (**Monitor, System Status**) at each end of the link and establish that there is a quiet wireless channel to use.
- 12 If there are no faults found in the configuration and there is absolutely no wireless signal, retry the installation procedure.
- 13 If this does not work then report a suspected AP/SM fault to Cambium Networks.

### LINK IS UNRELIABLE OR DOES NOT ACHIEVE DATA RATES REQUIRED

If there is some activity but the link is unreliable or does not achieve the data rates required, proceed as follows:

**Procedure:**

- 1 Check that the interference has not increased by monitoring the uplink and downlink CINR values reported in the AP page **Monitor, Wireless Status**
- 2 Check that the RSSI values reported at the AP and SM are proper based on the distance of the link – the LINKPlanner tool is designed to estimate these values.
- 3 Check that the path loss is low enough for the communication rates required.
- 4 Check that the AP or SM has not become misaligned.
- 5 Review your Quality of Service configuration and ensure that traffic is properly classified and prioritized.

## MODULE HAS LOST OR DOES NOT GAIN GPS SYNCHRONIZATION

To troubleshoot a loss of sync, perform the following steps.

**Procedure:**

- 1 If the AP is receiving synchronization via CMM, verify that the CMM is properly receiving sync via its attached GPS antenna (see *PMP Synchronization Solutions User Guide*). Verify that the cables from the CMM to the network switch are at most 30 Ft (shielded) or 10 Ft (unshielded) and that the network switch is not PoE (802.3af) capable.
- 2 If the CMM is receiving GPS synchronization pulses, verify that the AP's **Synchronization Source** is set to **CMM** and that the AP's GPS status bar icon is lit green.
- 3 If the AP is receiving synchronization via its internal GPS module and an external GPS antenna, verify the cabling from the AP to the GPS antenna, and verify that the AP's **Synchronization Source** is set to **GPS**.

## Using the device external reset button

ePMP APs and SMs feature an external button which serves two purposes:

- To reset the device (briefly depress the button for more than two seconds but less than ten seconds then release)



Caution

If the reset button is pressed for more than ten seconds while powered on, the device will reset back to its factory default configuration

- To reset the device to its factory default configuration (depress the button for more than ten seconds then release)

ePMP 1000 Connectorized Radio with Sync / ePMP 1000 Connectorized Radio Reset Button

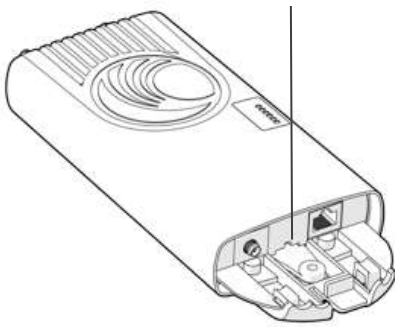

Force 180 Reset Button

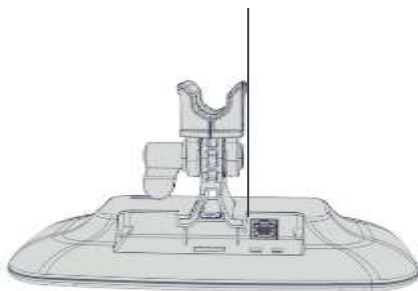

ePMP 1000 Integrated Radio Reset Button

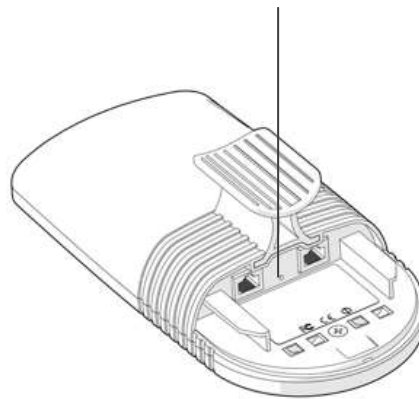

Force 200 Reset Button

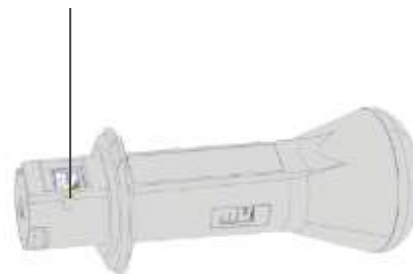

ePMP 2000 Access Point with Intelligent Filtering and Sync Reset Button





## Resetting ePMP to factory defaults by power cycling

Operators may reset an ePMP radio to default factory configuration by a sequence of power cycling (removing and re-applying power to the device). This procedure allows operators to perform a factory default reset without a tower climb or additional tools. The procedure is depicted in Figure 89.

### Procedure:

- 1 Remove the Ethernet cable from PoE jack of the power supply for at least 10 seconds.
- 2 Reconnect the Ethernet cable to re-supply power to the ePMP device for **3-5 seconds** and disconnect cable to power off the ePMP device for **3-5 seconds**. (1<sup>st</sup> power cycle)
- 3 Reconnect the Ethernet cable to re-supply power to the ePMP device for **3-5 seconds** and disconnect cable to power off the ePMP device for **3-5 seconds**. (2<sup>nd</sup> power cycle)
- 4 Reconnect the Ethernet cable to re-supply power to the ePMP device for **3-5 seconds** and disconnect cable to power off the ePMP device for **3-5 seconds**. (3<sup>rd</sup> power cycle)
- 5 Reconnect the Ethernet cable to re-supply power to the ePMP device for **3-5 seconds** and disconnect cable to power off the ePMP device for **3-5 seconds**. (4<sup>th</sup> power cycle)
- 6 Reconnect the Ethernet cable to re-supply power to the ePMP device for at least **30 seconds** and allow it to go through the boot up procedure (Note: Device will go through an additional reset automatically). This will reset the current configuration files to factory default configuration (e.g. IP addresses, Device mode, RF configuration etc.). The device can be pinged from a PC to check if boot up is complete (Successful ping replies indicates boot up is complete).
- 7 Access the ePMP device using the default IP address of 192.168.0.1 (AP) or 192.168.0.2 (SM).

**Figure 92** Power cycle timings

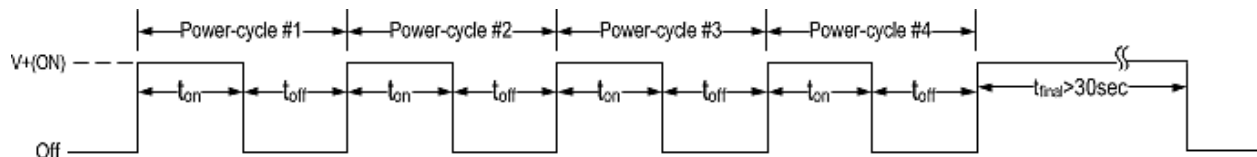

Where:

Is:

V+(ON)	Power through PoE has been applied to the device
Off	Power through PoE has been removed from the device
$t_{on}$	Time duration for which the device has been powered on. This should be 3-5 seconds.
$t_{off}$	Time duration for which the device has been powered off. This should be 3-5 seconds.

## Recovery of flash-corrupted ePMP devices

All ePMP radios, except the Connectorized Radios with Sync, have a single flash bank. There is a high probability that the flash bank can get corrupted when power to the radio is interrupted during a flash write, i.e. software upgrade. This is not an issue with the Sync radio since there are two flash banks in them – one active and the other inactive. The inactive bank will take over if the active bank is corrupted.

Beginning with Release 2.6.2, it is now possible to recover an ePMP radio's corrupted flash. In order to perform the recovery, the ePMP radio MUST be running Release 2.6.2 or higher. Recovery is not supported on devices running earlier releases or on Connectorized Radio with Sync (GPS radios).

### Procedure:

To perform the recovery procedure, the following is needed:

- 1 ePMP radio (non-GPS radio) with corrupted flash, i.e. there was a power interruption during a software upgrade and the device is no longer accessible or boots up.
- 2 The ePMP radio must have already been running Release 2.6.2 (or higher).
- 3 Laptop or PC with a 3rd party TFTP server (ex: <http://tftpd32.jounin.net>)

### Recovery Procedure:

- 1 Connect the PC/Laptop to the ePMP device (non-GPS radio).
- 2 The PC/Laptop must be deployed in the same network as the ePMP device.
- 3 TFTP Server IP address must be set to 192.168.1.10/255.255.255.0.
- 4 Extract the ePMP recovery image (**firmware.bin**) from the ePMP software bundle (*ePMP-NonGPS\_Synced-[Version].tar.gz*) and place it in the TFTP Server's root directory.
- 5 Reboot the ePMP device.
- 6 After successful boot-up, the ePMP device will perform the recovery procedure. The procedure will take approximately 5 minutes. Once done, the ePMP device will reboot automatically.
- 7 After boot-up, the ePMP device will be accessible using the last configured IP address or default local IP of 192.168.0.2 or the fallback IP of 169.254.1.1.
- 8 **IMPORTANT:** Software Upgrade through the GUI must be performed one more time for successful recovery in order to reflash broken image.

**NOTE:** This recovery procedure will work in cases where the u-boot of the radio is intact. In rare cases where the u-boot may also be corrupted, recovery is not possible.



### License Keys

**Entitlements**

Activate Entitlements

Recent Activations

My Entitlements

#### ePMP Elevate Licensing

Part Number	Description	Quantity Available
C09D0055014	ePMP Elevate 1 Subscriber License	10 of 10

ePMP Elevate Licenses can be bound to the MAC address of a single Access Point, or they can be deployed to a License Server and shared between multiple Access Points. How would you like to manage your licenses?

**Flexible Licensing**

With Flexible Licensing, your licenses are stored in a license server and can be shared among all your Access Points. Each Access Point will only use as many licenses as it has connected subscribers. When a subscriber disconnects, a license is returned to the pool and can be used by any other Access Point.

In order to use Flexible Licensing, your Access Points must:

- be able to make HTTPS requests out to the internet.
- be running firmware version 3.5 or greater.
- have an accurate NTP time source.

[Use Flexible Licensing](#)

**Fixed Licensing**

With Fixed Licensing, you will generate a license key for a specific MAC address, and load that license key into the Access Point. The license key represents the number of Elevate Subscribers that can be supported by that Access Point. The license key may not be transferred to any other Access Point.

You should use Fixed Licensing if your Access Points:

- can't make HTTPS requests to the internet.
- are running firmware version 3.4.1 or earlier, or
- don't have an accurate NTP time source.

[Use Fixed Licensing](#)

[Terms and Conditions](#) | [Privacy Policy](#)

[Chat](#)

5 Click **Activate** on the resulting page to activate your company account.

### License Keys

**Entitlements**

Activate Entitlements

Recent Activations

My Entitlements

#### Cloud Licensing

Part Number	Description	Quantity Available
C09D0055014	ePMP Elevate 1 Subscriber License	10 of 10

Cloud licenses must be associated with a company account. Please select the account you would like to use, or [create a new company account](#).

Cambium ID	Name	Cloud Licensing ID
XXXXXXXXXX	XXXXXXXXXX	Not assigned

[New Company Account](#)

6 On the resulting dialogue, enter the number of licenses to activate then click **Activate**.

### License Keys

**Entitlements**

- Activate Entitlements
- Recent Activations
- My Entitlements

**License Keys**

- ePMP 1000/2000
- PMP / PTP 450
- PTP 300/400/500/600/800
- PTP 650
- PTP 670
- PTP 700
- PTP 810
- PTP 820

#### Cloud Licensing

You are going to activate cloud licenses for this Company account:

Cambium ID	Name	Cloud Licensing ID
MARTIN_GRAY	Martin Gray	*****

Please enter the quantity you would like to activate from the entitlement:

Description	Quantity Available	Quantity to Activate
ePMP Elevate: 1 Subscriber License	0 of 10	<input type="text"/>

[Activate](#)

7 The recently-activated license keys are displayed, click **Details** to display the corresponding license key information.

Cambium Networks | Support Center

Knowledge Base Downloads Warranty License Keys Beta FAQ My Requests

Submit a request Martin Gray

### License Keys

Serial Number, Part Number or Description

10 results [Search](#)

Date	Description	Serial Number	License
2017-08-21	ePMP Elevate: 1 Subscriber License	-	<a href="#">Details</a>

8 To use licenses from the pool, enter the corresponding Cloud Licensing ID on the AP's License Management page. See [AP License Management](#) page on page 183 for more information.



Caution

Keep your **Cloud Licensing ID** secret to avoid unintended license pool usage!

## License Keys

Entitlements
Active Entitlements
<b>Recent Activations</b>
My Entitlements

License Keys
ePMP 1000/1000
PTP / PTP #50
PTP 300/400/500/600/800
PTP 650
PTP 675
PTP 700
PTP 810
PTP 820

**License Request:** ePMP Elevate: 1 Subscriber License

<b>State:</b>	Complete
<b>Date:</b>	2017-05-21
<b>Entitlement ID:</b>	[Redacted]
<b>Quantity:</b>	1
<b>Cloud Licensing ID:</b>	[Redacted] ←
<b>Company Account:</b>	[Redacted]

These licenses have been loaded into the Cambium Cloud Licensing system. To access them, enter the Cloud Licensing ID above into your device.





## Legal and reference information

This chapter provides legal notices including software license agreements.

---



Caution

Intentional or unintentional changes or modifications to the equipment must not be made unless under the express consent of the party responsible for compliance. Any such modifications could void the user's authority to operate the equipment and will void the manufacturer's warranty.

The following topics are described in this chapter:

- **Cambium Networks end user license agreement** on page **314**
- **Hardware warranty** on page **424**
- **Limit of liability** on page **425**
- **Compliance with safety standards** on page **426** lists the safety specifications against which the ePMP has been tested and certified. It also describes how to keep RF exposure within safe limits.
- **Compliance with radio regulations** on page **444** describes how the ePMP complies with the radio regulations that are enforced in various countries.
- **Notifications** on page **466** contains notes made to regulatory bodies for the ePMP.
- **Data throughput tables** on page **477** contain tables and graphs to support calculation of the data rate capacity that can be provided by ePMP configurations.

## Cambium Networks end user license agreement

### ACCEPTANCE OF THIS AGREEMENT

In connection with Cambium Networks' delivery of certain proprietary software or products containing embedded or pre-loaded proprietary software, or both, Cambium Networks is willing to license this certain proprietary software and the accompanying documentation to you only on the condition that you accept all the terms in this End User License Agreement ("Agreement").

IF YOU DO NOT AGREE TO THE TERMS OF THIS AGREEMENT, DO NOT USE THE PRODUCT OR INSTALL THE SOFTWARE. INSTEAD, YOU MAY, FOR A FULL REFUND, RETURN THIS PRODUCT TO THE LOCATION WHERE YOU ACQUIRED IT OR PROVIDE WRITTEN VERIFICATION OF DELETION OF ALL COPIES OF THE SOFTWARE. ANY USE OF THE SOFTWARE, INCLUDING BUT NOT LIMITED TO USE ON THE PRODUCT, WILL CONSTITUTE YOUR ACCEPTANCE TO THE TERMS OF THIS AGREEMENT.

### DEFINITIONS

In this Agreement, the word "Software" refers to the set of instructions for computers, in executable form and in any media, (which may include diskette, CD-ROM, downloadable internet, hardware, or firmware) licensed to you. The word "Documentation" refers to electronic or printed manuals and accompanying instructional aids licensed to you. The word "Product" refers to Cambium Networks' fixed wireless broadband devices for which the Software and Documentation is licensed for use.

### GRANT OF LICENSE

Cambium Networks Limited ("Cambium") grants you ("Licensee" or "you") a personal, nonexclusive, non-transferable license to use the Software and Documentation subject to the Conditions of Use set forth in "**Conditions of use**" and the terms and conditions of this Agreement. Any terms or conditions relating to the Software and Documentation appearing on the face or reverse side of any purchase order, purchase order acknowledgment or other order document that are different from, or in addition to, the terms of this Agreement will not be binding on the parties, even if payment is accepted.

### CONDITIONS OF USE

Any use of the Software and Documentation outside of the conditions set forth in this Agreement is strictly prohibited and will be deemed a breach of this Agreement.

1. Only you, your employees or agents may use the Software and Documentation. You will take all necessary steps to insure that your employees and agents abide by the terms of this Agreement.
2. You will use the Software and Documentation (i) only for your internal business purposes; (ii) only as described in the Software and Documentation; and (iii) in strict accordance with this Agreement.
3. You may use the Software and Documentation, provided that the use is in conformance with the terms set forth in this Agreement.

4. Portions of the Software and Documentation are protected by United States copyright laws, international treaty provisions, and other applicable laws. Therefore, you must treat the Software like any other copyrighted material (for example, a book or musical recording) except that you may either: (i) make 1 copy of the transportable part of the Software (which typically is supplied on diskette, CD-ROM, or downloadable internet), solely for back-up purposes; or (ii) copy the transportable part of the Software to a PC hard disk, provided you keep the original solely for back-up purposes. If the Documentation is in printed form, it may not be copied. If the Documentation is in electronic form, you may print out 1 copy, which then may not be copied. With regard to the copy made for backup or archival purposes, you agree to reproduce any Cambium Networks copyright notice, and other proprietary legends appearing thereon. Such copyright notice(s) may appear in any of several forms, including machine-readable form, and you agree to reproduce such notice in each form in which it appears, to the extent it is physically possible to do so. Unauthorized duplication of the Software or Documentation constitutes copyright infringement, and in the United States is punishable in federal court by fine and imprisonment.

5. You will not transfer, directly or indirectly, any product, technical data or software to any country for which the United States Government requires an export license or other governmental approval without first obtaining such license or approval.

## TITLE AND RESTRICTIONS

If you transfer possession of any copy of the Software and Documentation to another party outside of the terms of this agreement, your license is automatically terminated. Title and copyrights to the Software and Documentation and any copies made by you remain with Cambium Networks and its licensors. You will not, and will not permit others to: (i) modify, translate, decompile, bootleg, reverse engineer, disassemble, or extract the inner workings of the Software or Documentation, (ii) copy the look-and-feel or functionality of the Software or Documentation; (iii) remove any proprietary notices, marks, labels, or logos from the Software or Documentation; (iv) rent or transfer all or some of the Software or Documentation to any other party without Cambium's prior written consent; or (v) utilize any computer software or hardware which is designed to defeat any copy protection device, should the Software and Documentation be equipped with such a protection device. If the Software and Documentation is provided on multiple types of media (such as diskette, CD-ROM, downloadable internet), then you will only use the medium which best meets your specific needs, and will not loan, rent, lease, or transfer the other media contained in the package without Cambium's written consent. Unauthorized copying of the Software or Documentation, or failure to comply with any of the provisions of this Agreement, will result in automatic termination of this license.

## CONFIDENTIALITY

You acknowledge that all Software and Documentation contain valuable proprietary information and trade secrets and that unauthorized or improper use of the Software and Documentation will result in irreparable harm to Cambium Networks for which monetary damages would be inadequate and for which Cambium Networks will be entitled to immediate injunctive relief. If applicable, you will limit access to the Software and Documentation to those of your employees and agents who need to use the Software and Documentation for your internal business purposes, and you will take appropriate action with those employees and agents to preserve the confidentiality of the Software and Documentation, using the same degree of care to avoid unauthorized or improper disclosure as you use for the protection of your own proprietary software, but in no event less than reasonable care.

You have no obligation to preserve the confidentiality of any proprietary information that: (i) was in the public domain at the time of disclosure; (ii) entered the public domain through no fault of yours; (iii) was given to you free of any obligation to keep it confidential; (iv) is independently developed by you; or (v) is disclosed as required by law provided that you notify Cambium Networks prior to such disclosure and provide Cambium Networks with a reasonable opportunity to respond.

## RIGHT TO USE CAMBIUM'S NAME

Except as required in "**Conditions of use**", you will not, during the term of this Agreement or thereafter, use any trademark of Cambium Networks, or any word or symbol likely to be confused with any Cambium Networks trademark, either alone or in any combination with another word or words.

## TRANSFER

The Software and Documentation may not be transferred to another party without the express written consent of Cambium Networks, regardless of whether or not such transfer is accomplished by physical or electronic means. Cambium's consent may be withheld at its discretion and may be conditioned upon transferee paying all applicable license fees and agreeing to be bound by this Agreement.

## UPDATES

During the first 12 months after purchase of a Product, or during the term of any executed Maintenance and Support Agreement for the Product, you are entitled to receive Updates. An "Update" means any code in any form which is a bug fix, patch, error correction, or minor enhancement, but excludes any major feature added to the Software. Updates are available for download at the support website.

Major features may be available from time to time for an additional license fee. If Cambium Networks makes available to you major features and no other end user license agreement is provided, then the terms of this Agreement will apply.

## MAINTENANCE

Except as provided above, Cambium Networks is not responsible for maintenance or field service of the Software under this Agreement.

## DISCLAIMER

CAMBIUM NETWORKS DISCLAIMS ALL WARRANTIES OF ANY KIND, WHETHER EXPRESS, IMPLIED, STATUTORY, OR IN ANY COMMUNICATION WITH YOU. CAMBIUM NETWORKS SPECIFICALLY DISCLAIMS ANY WARRANTY INCLUDING THE IMPLIED WARRANTIES OF MERCHANTABILITY, NONINFRINGEMENT, OR FITNESS FOR A PARTICULAR PURPOSE. THE SOFTWARE AND DOCUMENTATION ARE PROVIDED "AS IS." CAMBIUM NETWORKS DOES NOT WARRANT THAT THE SOFTWARE WILL MEET YOUR REQUIREMENTS, OR THAT THE OPERATION OF THE SOFTWARE WILL BE UNINTERRUPTED OR ERROR FREE, OR THAT DEFECTS IN THE SOFTWARE WILL BE CORRECTED. CAMBIUM NETWORKS MAKES NO WARRANTY WITH RESPECT TO THE CORRECTNESS, ACCURACY, OR RELIABILITY OF THE SOFTWARE AND DOCUMENTATION. Some jurisdictions do not allow the exclusion of implied warranties, so the above exclusion may not apply to you.

## LIMITATION OF LIABILITY

IN NO EVENT SHALL CAMBIUM NETWORKS BE LIABLE TO YOU OR ANY OTHER PARTY FOR ANY DIRECT, INDIRECT, GENERAL, SPECIAL, INCIDENTAL, CONSEQUENTIAL, EXEMPLARY OR OTHER DAMAGE ARISING OUT OF THE USE OR INABILITY TO USE THE PRODUCT (INCLUDING, WITHOUT LIMITATION, DAMAGES FOR LOSS OF BUSINESS PROFITS, BUSINESS INTERRUPTION, LOSS OF BUSINESS INFORMATION OR ANY OTHER PECUNIARY LOSS, OR FROM ANY BREACH OF WARRANTY, EVEN IF CAMBIUM NETWORKS HAS BEEN ADVISED OF THE POSSIBILITY OF SUCH DAMAGES. (Some states do not allow the exclusion or limitation of incidental or consequential damages, so the above exclusion or limitation may not apply to you.) IN NO CASE SHALL CAMBIUM'S LIABILITY EXCEED THE AMOUNT YOU PAID FOR THE PRODUCT.

## U.S. GOVERNMENT

If you are acquiring the Product on behalf of any unit or agency of the U.S. Government, the following applies. Use, duplication, or disclosure of the Software and Documentation is subject to the restrictions set forth in subparagraphs (c) (1) and (2) of the Commercial Computer Software – Restricted Rights clause at FAR 52.227-19 (JUNE 1987), if applicable, unless being provided to the Department of Defense. If being provided to the Department of Defense, use, duplication, or disclosure of the Products is subject to the restricted rights set forth in subparagraph (c) (1) (ii) of the Rights in Technical Data and Computer Software clause at DFARS 252.227-7013 (OCT 1988), if applicable. Software and Documentation may or may not include a Restricted Rights notice, or other notice referring specifically to the terms and conditions of this Agreement. The terms and conditions of this Agreement will each continue to apply, but only to the extent that such terms and conditions are not inconsistent with the rights provided to you under the aforementioned provisions of the FAR and DFARS, as applicable to the particular procuring agency and procurement transaction.

## TERM OF LICENSE

Your right to use the Software will continue in perpetuity unless terminated as follows. Your right to use the Software will terminate immediately without notice upon a breach of this Agreement by you. Within 30 days after termination of this Agreement, you will certify to Cambium Networks in writing that through your best efforts, and to the best of your knowledge, the original and all copies, in whole or in part, in any form, of the Software and all related material and Documentation, have been destroyed, except that, with prior written consent from Cambium Networks, you may retain one copy for archival or backup purposes. You may not sublicense, assign or transfer the license or the Product, except as expressly provided in this Agreement. Any attempt to otherwise sublicense, assign or transfer any of the rights, duties or obligations hereunder is null and void.

## GOVERNING LAW

This Agreement is governed by the laws of the United States of America to the extent that they apply and otherwise by the laws of the State of Illinois.

## ASSIGNMENT

This agreement may not be assigned by you without Cambium's prior written consent.

## SURVIVAL OF PROVISIONS

The parties agree that where the context of any provision indicates an intent that it survives the term of this Agreement, then it will survive.

## ENTIRE AGREEMENT

This agreement contains the parties' entire agreement regarding your use of the Software and may be amended only in writing signed by both parties, except that Cambium Networks may modify this Agreement as necessary to comply with applicable laws.

## THIRD PARTY SOFTWARE

The software may contain one or more items of Third-Party Software supplied by other third-party suppliers. The terms of this Agreement govern your use of any Third-Party Software UNLESS A SEPARATE THIRD-PARTY SOFTWARE LICENSE IS INCLUDED, IN WHICH CASE YOUR USE OF THE THIRD-PARTY SOFTWARE WILL THEN BE GOVERNED BY THE SEPARATE THIRD-PARTY LICENSE.

### SOURCE CODE REQUESTS

Where required under the terms of the open source software license applicable to Cambium’s use of each of the following open source software packages, for at least three (3) years from the date of your receipt of the copy of such open source software, Cambium will provide to any party who contacts us at the contact information provided below a copy of the source code for the version of the requested open source software used in this Cambium product.

Cambium Networks  
Atrium, 3800 Golf Rd #360  
Rolling Meadows, IL 60008

*Aquila*

Copyright (c) 2002-2010, Atheros Communications Inc.  
Copyright (c) 2002-2005 Sam Leffler, Errno Consulting  
Copyright (C) 2011 Denali Software Inc. All rights reserved

Permission to use, copy, modify, and/or distribute this software for any purpose with or without fee is hereby granted, provided that the above copyright notice and this permission notice appear in all copies.

THE SOFTWARE IS PROVIDED "AS IS" AND THE AUTHOR DISCLAIMS ALL WARRANTIES WITH REGARD TO THIS SOFTWARE INCLUDING ALL IMPLIED WARRANTIES OF MERCHANTABILITY AND FITNESS. IN NO EVENT SHALL THE AUTHOR BE LIABLE FOR ANY SPECIAL, DIRECT, INDIRECT, OR CONSEQUENTIAL DAMAGES OR ANY DAMAGES WHATSOEVER RESULTING FROM LOSS OF USE, DATA OR PROFITS, WHETHER IN AN ACTION OF CONTRACT, NEGLIGENCE OR OTHER TORTIOUS ACTION, ARISING OUT OF OR IN CONNECTION WITH THE USE OR PERFORMANCE OF THIS SOFTWARE.

=====

Redistribution and use in source and binary forms are permitted provided that the following conditions are met:  
1. The materials contained herein are unmodified and are used unmodified.

2. Redistributions of source code must retain the above copyright notice, this list of conditions and the following NO "WARRANTY" disclaimer below ("Disclaimer"), without modification.
3. Redistributions in binary form must reproduce at minimum a disclaimer similar to the Disclaimer below and any redistribution must be conditioned upon including a substantially similar Disclaimer requirement for further binary redistribution.
4. Neither the names of the above-listed copyright holders nor the names of any contributors may be used to endorse or promote product derived from this software without specific prior written permission.

#### NO WARRANTY

THIS SOFTWARE IS PROVIDED BY THE COPYRIGHT HOLDERS AND CONTRIBUTORS "AS IS" AND ANY EXPRESS OR IMPLIED WARRANTIES, INCLUDING, BUT NOT LIMITED TO, THE IMPLIED WARRANTIES OF NONINFRINGEMENT, MERCHANTABILITY AND FITNESS FOR A PARTICULAR PURPOSE ARE DISCLAIMED. IN NO EVENT SHALL THE COPYRIGHT HOLDERS OR CONTRIBUTORS BE LIABLE FOR SPECIAL, EXEMPLARY, OR CONSEQUENTIAL DAMAGES (INCLUDING, BUT NOT LIMITED TO, PROCUREMENT OF SUBSTITUTE GOODS OR SERVICES; LOSS OF USE, DATA, OR PROFITS; OR BUSINESS INTERRUPTION) HOWEVER CAUSED AND ON ANY THEORY OF LIABILITY, WHETHER IN CONTRACT, STRICT LIABILITY, OR TORT (INCLUDING NEGLIGENCE OR OTHERWISE) ARISING IN ANY WAY OUT OF THE USE OF THIS SOFTWARE, EVEN IF ADVISED OF THE POSSIBILITY OF SUCH DAMAGES.

# (C) Copyright 2002-2006

# Wolfgang Denk, DENX Software Engineering, wd@denx.de.

#

# See file CREDITS for list of people who contributed to this  
# project.

#

# This program is free software; you can redistribute it and/or  
# modify it under the terms of the GNU General Public License as  
# published by the Free Software Foundation; either version 2 of  
# the License, or (at your option) any later version.

#

# This program is distributed in the hope that it will be useful,  
# but WITHOUT ANY WARRANTY; without even the implied warranty of  
# MERCHANTABILITY or FITNESS FOR A PARTICULAR PURPOSE. See the  
# GNU General Public License for more details.

#

# You should have received a copy of the GNU General Public License  
# along with this program; if not, write to the Free Software  
# Foundation, Inc., 59 Temple Place, Suite 330, Boston,  
# MA 02111-1307 USA

#

*Linux Kernel*

Copyright (c) 1989, 1991 Free Software Foundation

NOTE! This copyright does *\*not\** cover user programs that use kernel services by normal system calls - this is merely considered normal use of the kernel, and does *\*not\** fall under the heading of "derived work". Also note that the GPL below is copyrighted by the Free Software Foundation, but the instance of code that it refers to (the Linux kernel) is copyrighted by me and others who actually wrote it.

Also note that the only valid version of the GPL as far as the kernel is concerned is *\_this\_* particular version of the license (ie v2, not v2.2 or v3.x or whatever), unless explicitly otherwise stated.

Linus Torvalds

-----  
GNU GENERAL PUBLIC LICENSE  
Version 2, June 1991

Copyright (C) 1989, 1991 Free Software Foundation, Inc.  
51 Franklin St, Fifth Floor, Boston, MA 02110-1301 USA  
Everyone is permitted to copy and distribute verbatim copies  
of this license document, but changing it is not allowed.

See full license text on page [335](#).

```
# (C) Copyright 2002-2006
# Wolfgang Denk, DENX Software Engineering, wd@denx.de.
#
# See file CREDITS for list of people who contributed to this
# project.
#
# This program is free software; you can redistribute it and/or
# modify it under the terms of the GNU General Public License as
# published by the Free Software Foundation; either version 2 of
# the License, or (at your option) any later version.
#
# This program is distributed in the hope that it will be useful,
# but WITHOUT ANY WARRANTY; without even the implied warranty of
# MERCHANTABILITY or FITNESS FOR A PARTICULAR PURPOSE. See the
# GNU General Public License for more details.
#
# You should have received a copy of the GNU General Public License
```



```
# along with this program; if not, write to the Free Software  
# Foundation, Inc., 59 Temple Place, Suite 330, Boston,  
# MA 02111-1307 USA  
#
```

*gpio\_keys*

```

/*
 * Driver for keys on GPIO lines capable of generating interrupts.
 *
 * Copyright 2005 Phil Blundell
 *
 * This program is free software; you can redistribute it and/or modify
 * it under the terms of the GNU General Public License version 2 as
 * published by the Free Software Foundation.
 */

# (C) Copyright 2002-2006
# Wolfgang Denk, DENX Software Engineering, wd@denx.de.
#
# See file CREDITS for list of people who contributed to this
# project.
#
# This program is free software; you can redistribute it and/or
# modify it under the terms of the GNU General Public License as
# published by the Free Software Foundation; either version 2 of
# the License, or (at your option) any later version.
#
# This program is distributed in the hope that it will be useful,
# but WITHOUT ANY WARRANTY; without even the implied warranty of
# MERCHANTABILITY or FITNESS FOR A PARTICULAR PURPOSE. See the
# GNU General Public License for more details.
#
# You should have received a copy of the GNU General Public License
# along with this program; if not, write to the Free Software
# Foundation, Inc., 59 Temple Place, Suite 330, Boston,
# MA 02111-1307 USA
#

```

*OpenWrt*

```

GNU GENERAL PUBLIC LICENSE
Version 2, June 1991

Copyright (C) 1989, 1991 Free Software Foundation, Inc.
59 Temple Place, Suite 330, Boston, MA 02111-1307 USA
Everyone is permitted to copy and distribute verbatim copies
of this license document, but changing it is not allowed.

See full license text on page 335.

# (C) Copyright 2002-2006
# Wolfgang Denk, DENX Software Engineering, wd@denx.de.
#
# See file CREDITS for list of people who contributed to this
# project.
#
# This program is free software; you can redistribute it and/or
# modify it under the terms of the GNU General Public License as
# published by the Free Software Foundation; either version 2 of

```

	<pre># the License, or (at your option) any later version. # # This program is distributed in the hope that it will be useful, # but WITHOUT ANY WARRANTY; without even the implied warranty of # MERCHANTABILITY or FITNESS FOR A PARTICULAR PURPOSE. See the # GNU General Public License for more details. # # You should have received a copy of the GNU General Public License # along with this program; if not, write to the Free Software # Foundation, Inc., 59 Temple Place, Suite 330, Boston, # MA 02111-1307 USA #</pre>
<i>uboot</i>	<p>Copyright (c) 2007 Wolfgang Denk, DENIX Software Engineering, <a href="mailto:wd@denix.de">wd@denix.de</a></p> <pre># (C) Copyright 2000 - 2005 # Wolfgang Denk, DENIX Software Engineering, wd@denx.de. # # See file CREDITS for list of people who contributed to this # project. # # This program is free software; you can redistribute it and/or # modify it under the terms of the GNU General Public License as # published by the Free Software Foundation; either version 2 of # the License, or (at your option) any later version. # # This program is distributed in the hope that it will be useful, # but WITHOUT ANY WARRANTY; without even the implied warranty of # MERCHANTABILITY or FITNESS FOR A PARTICULAR PURPOSE. See the # GNU General Public License for more details. # # You should have received a copy of the GNU General Public License # along with this program; if not, write to the Free Software # Foundation, Inc., 59 Temple Place, Suite 330, Boston, # MA 02111-1307 USA</pre> <p>See full license text on page <a href="#">335</a>.</p>
<i>uboot</i> (Force products released in 2017)	<p>NOTE! This copyright does <i>*not*</i> cover the so-called "standalone" applications that use U-Boot services by means of the jump table provided by U-Boot exactly for this purpose - this is merely considered normal use of U-Boot, and does <i>*not*</i> fall under the heading of "derived work".</p> <p>The header files "include/image.h" and "include/asm-*/u-boot.h" define interfaces to U-Boot. Including these (unmodified) header files in another file is considered normal use of U-Boot, and does <i>*not*</i> fall under the heading of "derived work".</p> <p>Also note that the GPL below is copyrighted by the Free Software Foundation, but the instance of code that it refers to (the U-Boot</p>

source code) is copyrighted by me and others who actually wrote it.  
 -- Wolfgang Denk

=====  
 GNU GENERAL PUBLIC LICENSE  
 Version 2, June 1991

Copyright (C) 1989, 1991 Free Software Foundation, Inc.  
 59 Temple Place, Suite 330, Boston, MA 02111-1307 USA  
 Everyone is permitted to copy and distribute verbatim copies  
 of this license document, but changing it is not allowed.

See full license text on page [335](#).

```

/*
 * (C) Copyright 2000-2009
 * Wolfgang Denk, DENX Software Engineering, wd@denx.de.
 *
 * See file CREDITS for list of people who contributed to this
 * project.
 *
 * This program is free software; you can redistribute it and/or
 * modify it under the terms of the GNU General Public License as
 * published by the Free Software Foundation; either version 2 of
 * the License, or (at your option) any later version.
 *
 * This program is distributed in the hope that it will be useful,
 * but WITHOUT ANY WARRANTY; without even the implied warranty of
 * MERCHANTABILITY or FITNESS FOR A PARTICULAR PURPOSE. See the
 * GNU General Public License for more details.
 *
 * You should have received a copy of the GNU General Public License
 * along with this program; if not, write to the Free Software
 * Foundation, Inc., 59 Temple Place, Suite 330, Boston,
 * MA 02111-1307 USA
 */
/*
 * Command Processor Table
 */

```

*jQuery*

The MIT License (MIT)

Copyright (c) 2013 The jQuery Foundation.

Permission is hereby granted, free of charge, to any person obtaining a copy of this software and associated documentation files (the "Software"), to deal in the Software without restriction, including without limitation the rights to use, copy, modify, merge, publish, distribute, sublicense, and/or sell copies of the Software, and to permit persons to whom the Software is furnished to do so, subject to the following conditions:

The above copyright notice and this permission notice shall be included in all copies or substantial portions of the Software.

THE SOFTWARE IS PROVIDED "AS IS", WITHOUT WARRANTY OF ANY KIND, EXPRESS OR IMPLIED, INCLUDING BUT NOT LIMITED TO THE WARRANTIES OF MERCHANTABILITY, FITNESS FOR A PARTICULAR PURPOSE AND NONINFRINGEMENT. IN NO EVENT SHALL THE AUTHORS OR COPYRIGHT HOLDERS BE LIABLE FOR ANY CLAIM, DAMAGES OR OTHER LIABILITY, WHETHER IN AN ACTION OF CONTRACT, TORT OR OTHERWISE, ARISING FROM, OUT OF OR IN CONNECTION WITH THE SOFTWARE OR THE USE OR OTHER DEALINGS IN THE SOFTWARE.

```
# (C) Copyright 2002-2006
# Wolfgang Denk, DENX Software Engineering, wd@denx.de.
#
# See file CREDITS for list of people who contributed to this
# project.
#
# This program is free software; you can redistribute it and/or
# modify it under the terms of the GNU General Public License as
# published by the Free Software Foundation; either version 2 of
# the License, or (at your option) any later version.
#
# This program is distributed in the hope that it will be useful,
# but WITHOUT ANY WARRANTY; without even the implied warranty of
# MERCHANTABILITY or FITNESS FOR A PARTICULAR PURPOSE. See the
# GNU General Public License for more details.
#
# You should have received a copy of the GNU General Public License
# along with this program; if not, write to the Free Software
# Foundation, Inc., 59 Temple Place, Suite 330, Boston,
# MA 02111-1307 USA
#
```

***Data-Driven  
Document***

Copyright (c) 2012, Michael Bostock

Copyright (c) 2013, Michael Bostock

All rights reserved.

Redistribution and use in source and binary forms, with or without modification, are permitted provided that the following conditions are met:

\* Redistributions of source code must retain the above copyright notice, this list of conditions and the following disclaimer.

\* Redistributions in binary form must reproduce the above copyright notice, this list of conditions and the following disclaimer in the documentation and/or other materials provided with the distribution.

\* The name Michael Bostock may not be used to endorse or promote products derived from this software without specific prior written permission.

THIS SOFTWARE IS PROVIDED BY THE COPYRIGHT HOLDERS AND CONTRIBUTORS "AS IS" AND ANY EXPRESS OR IMPLIED WARRANTIES, INCLUDING, BUT NOT LIMITED TO, THE IMPLIED WARRANTIES OF MERCHANTABILITY AND FITNESS FOR A PARTICULAR PURPOSE ARE DISCLAIMED. IN NO EVENT SHALL MICHAEL BOSTOCK BE LIABLE FOR ANY DIRECT, INDIRECT, INCIDENTAL, SPECIAL, EXEMPLARY, OR CONSEQUENTIAL DAMAGES (INCLUDING, BUT NOT LIMITED TO, PROCUREMENT OF SUBSTITUTE GOODS OR SERVICES; LOSS OF USE, DATA, OR PROFITS; OR BUSINESS INTERRUPTION) HOWEVER CAUSED AND ON ANY THEORY OF LIABILITY, WHETHER IN CONTRACT, STRICT LIABILITY, OR TORT (INCLUDING NEGLIGENCE OR OTHERWISE) ARISING IN ANY WAY OUT OF THE USE OF THIS SOFTWARE, EVEN IF ADVISED OF THE POSSIBILITY OF SUCH DAMAGE.

# (C) Copyright 2002-2006

# Wolfgang Denk, DENX Software Engineering, wd@denx.de.

#

# See file CREDITS for list of people who contributed to this project.

#

# This program is free software; you can redistribute it and/or modify it under the terms of the GNU General Public License as published by the Free Software Foundation; either version 2 of the License, or (at your option) any later version.

#

# This program is distributed in the hope that it will be useful, but WITHOUT ANY WARRANTY; without even the implied warranty of MERCHANTABILITY or FITNESS FOR A PARTICULAR PURPOSE. See the GNU General Public License for more details.

#

# You should have received a copy of the GNU General Public License along with this program; if not, write to the Free Software Foundation, Inc., 59 Temple Place, Suite 330, Boston, MA 02111-1307 USA

#

*AjaxFileUpload*

The MIT License (MIT)

Copyright 2013-2014 powered by PHPLETTER

Permission is hereby granted, free of charge, to any person obtaining a copy of this software and associated documentation files (the "Software"), to deal in the Software without restriction, including without limitation the rights to use, copy, modify, merge, publish, distribute, sublicense, and/or sell copies of the Software, and to permit persons to whom the Software is furnished to do so, subject to the following conditions:

The above copyright notice and this permission notice shall be included in all copies or substantial portions of the Software.

THE SOFTWARE IS PROVIDED "AS IS", WITHOUT WARRANTY OF ANY KIND, EXPRESS OR IMPLIED, INCLUDING BUT NOT LIMITED TO THE WARRANTIES OF MERCHANTABILITY, FITNESS FOR A PARTICULAR PURPOSE AND NONINFRINGEMENT. IN NO EVENT SHALL THE AUTHORS OR COPYRIGHT HOLDERS BE LIABLE FOR ANY CLAIM, DAMAGES OR OTHER LIABILITY, WHETHER IN AN ACTION OF CONTRACT, TORT OR OTHERWISE, ARISING FROM, OUT OF OR IN CONNECTION WITH THE SOFTWARE OR THE USE OR OTHER DEALINGS IN THE SOFTWARE.

```
# (C) Copyright 2002-2006
# Wolfgang Denk, DENX Software Engineering, wd@denx.de.
#
# See file CREDITS for list of people who contributed to this
# project.
#
# This program is free software; you can redistribute it and/or
# modify it under the terms of the GNU General Public License as
# published by the Free Software Foundation; either version 2 of
# the License, or (at your option) any later version.
#
# This program is distributed in the hope that it will be useful,
# but WITHOUT ANY WARRANTY; without even the implied warranty of
# MERCHANTABILITY or FITNESS FOR A PARTICULAR PURPOSE. See the
# GNU General Public License for more details.
#
# You should have received a copy of the GNU General Public License
# along with this program; if not, write to the Free Software
# Foundation, Inc., 59 Temple Place, Suite 330, Boston,
# MA 02111-1307 USA
#
```

*jquery.caret*

The MIT License (MIT)

Copyright (c) 2010 C. F., Wong

Permission is hereby granted, free of charge, to any person obtaining a copy of this software and associated documentation files (the "Software"), to deal in the Software without restriction, including without limitation the rights to use, copy, modify, merge, publish, distribute, sublicense, and/or sell copies of the Software, and to permit persons to whom the Software is furnished to do so, subject to the following conditions:

The above copyright notice and this permission notice shall be included in all copies or substantial portions of the Software.

THE SOFTWARE IS PROVIDED "AS IS", WITHOUT WARRANTY OF ANY KIND, EXPRESS OR IMPLIED, INCLUDING BUT NOT LIMITED TO THE WARRANTIES OF MERCHANTABILITY, FITNESS FOR A PARTICULAR PURPOSE AND NONINFRINGEMENT. IN NO EVENT SHALL THE AUTHORS OR COPYRIGHT HOLDERS BE LIABLE FOR ANY CLAIM, DAMAGES OR OTHER LIABILITY, WHETHER IN AN ACTION OF CONTRACT, TORT OR OTHERWISE, ARISING FROM, OUT OF OR IN CONNECTION WITH THE SOFTWARE OR THE USE OR OTHER DEALINGS IN THE SOFTWARE.

```
# (C) Copyright 2002-2006
# Wolfgang Denk, DENX Software Engineering, wd@denx.de.
#
# See file CREDITS for list of people who contributed to this
# project.
#
# This program is free software; you can redistribute it and/or
# modify it under the terms of the GNU General Public License as
# published by the Free Software Foundation; either version 2 of
# the License, or (at your option) any later version.
#
# This program is distributed in the hope that it will be useful,
# but WITHOUT ANY WARRANTY; without even the implied warranty of
# MERCHANTABILITY or FITNESS FOR A PARTICULAR PURPOSE. See the
# GNU General Public License for more details.
#
# You should have received a copy of the GNU General Public License
# along with this program; if not, write to the Free Software
# Foundation, Inc., 59 Temple Place, Suite 330, Boston,
# MA 02111-1307 USA
#
```

*jquery.cookie*

Copyright 2013 Klaus Hartl

Permission is hereby granted, free of charge, to any person obtaining a copy of this software and associated documentation files (the



"Software"), to deal in the Software without restriction, including without limitation the rights to use, copy, modify, merge, publish, distribute, sublicense, and/or sell copies of the Software, and to permit persons to whom the Software is furnished to do so, subject to the following conditions:

The above copyright notice and this permission notice shall be included in all copies or substantial portions of the Software.

THE SOFTWARE IS PROVIDED "AS IS", WITHOUT WARRANTY OF ANY KIND, EXPRESS OR IMPLIED, INCLUDING BUT NOT LIMITED TO THE WARRANTIES OF MERCHANTABILITY, FITNESS FOR A PARTICULAR PURPOSE AND NONINFRINGEMENT. IN NO EVENT SHALL THE AUTHORS OR COPYRIGHT HOLDERS BE LIABLE FOR ANY CLAIM, DAMAGES OR OTHER LIABILITY, WHETHER IN AN ACTION OF CONTRACT, TORT OR OTHERWISE, ARISING FROM, OUT OF OR IN CONNECTION WITH THE SOFTWARE OR THE USE OR OTHER DEALINGS IN THE SOFTWARE.

```
# (C) Copyright 2002-2006
# Wolfgang Denk, DENX Software Engineering, wd@denx.de.
#
# See file CREDITS for list of people who contributed to this
# project.
#
# This program is free software; you can redistribute it and/or
# modify it under the terms of the GNU General Public License as
# published by the Free Software Foundation; either version 2 of
# the License, or (at your option) any later version.
#
# This program is distributed in the hope that it will be useful,
# but WITHOUT ANY WARRANTY; without even the implied warranty of
# MERCHANTABILITY or FITNESS FOR A PARTICULAR PURPOSE. See the
# GNU General Public License for more details.
#
# You should have received a copy of the GNU General Public License
# along with this program; if not, write to the Free Software
# Foundation, Inc., 59 Temple Place, Suite 330, Boston,
# MA 02111-1307 USA
#
```

*json2.js*

<http://www.JSON.org/json2.js>

2010-08-25

Public Domain.

NO WARRANTY EXPRESSED OR IMPLIED. USE AT YOUR OWN RISK.

See <http://www.JSON.org/js.html>

This code must be minified before deployment.

See <http://javascript.crockford.com/jsmin.html>

USE YOUR OWN COPY. IT IS EXTREMELY UNWISE TO LOAD CODE FROM SERVERS YOU DO NOT CONTROL.

```
# (C) Copyright 2002-2006
# Wolfgang Denk, DENX Software Engineering, wd@denx.de.
#
# See file CREDITS for list of people who contributed to this
# project.
#
# This program is free software; you can redistribute it and/or
# modify it under the terms of the GNU General Public License as
# published by the Free Software Foundation; either version 2 of
# the License, or (at your option) any later version.
#
# This program is distributed in the hope that it will be useful,
# but WITHOUT ANY WARRANTY; without even the implied warranty of
# MERCHANTABILITY or FITNESS FOR A PARTICULAR PURPOSE. See the
# GNU General Public License for more details.
#
# You should have received a copy of the GNU General Public License
# along with this program; if not, write to the Free Software
# Foundation, Inc., 59 Temple Place, Suite 330, Boston,
# MA 02111-1307 USA
#
```

*jquery.noty*

Copyright (c) 2012 Nedim Arabacı

Permission is hereby granted, free of charge, to any person obtaining a copy of this software and associated documentation files (the "Software"), to deal in the Software without restriction, including without limitation the rights to use, copy, modify, merge, publish, distribute, sublicense, and/or sell copies of the Software, and to permit persons to whom the Software is furnished to do so, subject to the following conditions:

The above copyright notice and this permission notice shall be included in all copies or substantial portions of the Software.

THE SOFTWARE IS PROVIDED "AS IS", WITHOUT WARRANTY OF ANY KIND, EXPRESS OR IMPLIED, INCLUDING BUT NOT LIMITED TO THE WARRANTIES OF MERCHANTABILITY, FITNESS FOR A PARTICULAR PURPOSE AND NONINFRINGEMENT. IN NO EVENT SHALL THE AUTHORS OR COPYRIGHT HOLDERS BE LIABLE FOR ANY CLAIM, DAMAGES OR OTHER LIABILITY, WHETHER IN AN ACTION OF CONTRACT, TORT OR OTHERWISE, ARISING FROM, OUT OF OR IN CONNECTION WITH THE SOFTWARE OR THE USE OR OTHER DEALINGS IN THE SOFTWARE.

```
# (C) Copyright 2002-2006
# Wolfgang Denk, DENX Software Engineering, wd@denx.de.
#
# See file CREDITS for list of people who contributed to this
# project.
#
# This program is free software; you can redistribute it and/or
# modify it under the terms of the GNU General Public License as
# published by the Free Software Foundation; either version 2 of
# the License, or (at your option) any later version.
#
# This program is distributed in the hope that it will be useful,
# but WITHOUT ANY WARRANTY; without even the implied warranty of
# MERCHANTABILITY or FITNESS FOR A PARTICULAR PURPOSE. See the
# GNU General Public License for more details.
#
# You should have received a copy of the GNU General Public License
# along with this program; if not, write to the Free Software
# Foundation, Inc., 59 Temple Place, Suite 330, Boston,
# MA 02111-1307 USA
#
```

*SlickGrid*

Copyright (c) 2009-2012 Michael Leibman

Copyright (c) 2010 Michael Leibman

<http://github.com/mleibman/slickgrid>

Permission is hereby granted, free of charge, to any person obtaining a copy of this software and associated documentation files (the "Software"), to deal in the Software without restriction, including without limitation the rights to use, copy, modify, merge, publish, distribute, sublicense, and/or sell copies of the Software, and to permit persons to whom the Software is furnished to do so, subject to the following conditions:

The above copyright notice and this permission notice shall be included in all copies or substantial portions of the Software.

THE SOFTWARE IS PROVIDED "AS IS", WITHOUT WARRANTY OF ANY KIND, EXPRESS OR IMPLIED, INCLUDING BUT NOT LIMITED TO THE WARRANTIES OF MERCHANTABILITY, FITNESS FOR A PARTICULAR PURPOSE AND NONINFRINGEMENT. IN NO EVENT SHALL THE AUTHORS OR COPYRIGHT HOLDERS BE LIABLE FOR ANY CLAIM, DAMAGES OR OTHER LIABILITY, WHETHER IN AN ACTION OF CONTRACT, TORT OR OTHERWISE, ARISING FROM, OUT OF OR IN CONNECTION WITH THE SOFTWARE OR THE USE OR OTHER DEALINGS IN THE SOFTWARE.

# (C) Copyright 2002-2006

# Wolfgang Denk, DENX Software Engineering, wd@denx.de.

#

# See file CREDITS for list of people who contributed to this  
# project.

#

# This program is free software; you can redistribute it and/or  
# modify it under the terms of the GNU General Public License as  
# published by the Free Software Foundation; either version 2 of  
# the License, or (at your option) any later version.

#

# This program is distributed in the hope that it will be useful,  
# but WITHOUT ANY WARRANTY; without even the implied warranty of  
# MERCHANTABILITY or FITNESS FOR A PARTICULAR PURPOSE. See the  
# GNU General Public License for more details.

#

# You should have received a copy of the GNU General Public License  
# along with this program; if not, write to the Free Software  
# Foundation, Inc., 59 Temple Place, Suite 330, Boston,  
# MA 02111-1307 USA

#

*jquery.event.drag*

The MIT License (MIT)

Copyright (c) 2010 Three Dub Media

Permission is hereby granted, free of charge, to any person obtaining a copy of this software and associated documentation files (the "Software"), to deal in the Software without restriction, including without limitation the rights to use, copy, modify, merge, publish, distribute, sublicense, and/or sell copies of the Software, and to permit persons to whom the Software is furnished to do so, subject to the following conditions:

The above copyright notice and this permission notice shall be included in all copies or substantial portions of the Software.

THE SOFTWARE IS PROVIDED "AS IS", WITHOUT WARRANTY OF ANY KIND, EXPRESS OR IMPLIED, INCLUDING BUT NOT LIMITED TO THE WARRANTIES OF MERCHANTABILITY, FITNESS FOR A PARTICULAR PURPOSE AND NONINFRINGEMENT. IN NO EVENT SHALL THE AUTHORS OR COPYRIGHT HOLDERS BE LIABLE FOR ANY CLAIM, DAMAGES OR OTHER LIABILITY, WHETHER IN AN ACTION OF CONTRACT, TORT OR OTHERWISE, ARISING FROM, OUT OF OR IN CONNECTION WITH THE SOFTWARE OR THE USE OR OTHER DEALINGS IN THE SOFTWARE.

```
# (C) Copyright 2002-2006
# Wolfgang Denk, DENX Software Engineering, wd@denx.de.
#
# See file CREDITS for list of people who contributed to this
# project.
#
# This program is free software; you can redistribute it and/or
# modify it under the terms of the GNU General Public License as
# published by the Free Software Foundation; either version 2 of
# the License, or (at your option) any later version.
#
# This program is distributed in the hope that it will be useful,
# but WITHOUT ANY WARRANTY; without even the implied warranty of
# MERCHANTABILITY or FITNESS FOR A PARTICULAR PURPOSE. See the
# GNU General Public License for more details.
#
# You should have received a copy of the GNU General Public License
# along with this program; if not, write to the Free Software
# Foundation, Inc., 59 Temple Place, Suite 330, Boston,
# MA 02111-1307 USA
#
```

IE9.js

The MIT License (MIT)

Copyright (c) 2004-2010, Dean Edwards

Permission is hereby granted, free of charge, to any person obtaining a copy of this software and associated documentation files (the "Software"), to deal in the Software without restriction, including without limitation the rights to use, copy, modify, merge, publish, distribute, sublicense, and/or sell copies of the Software, and to permit persons to whom the Software is furnished to do so, subject to the following conditions:

The above copyright notice and this permission notice shall be included in all copies or substantial portions of the Software.

THE SOFTWARE IS PROVIDED "AS IS", WITHOUT WARRANTY OF ANY KIND, EXPRESS OR IMPLIED, INCLUDING BUT NOT LIMITED TO THE WARRANTIES OF MERCHANTABILITY, FITNESS FOR A PARTICULAR PURPOSE AND NONINFRINGEMENT. IN NO EVENT SHALL THE AUTHORS OR COPYRIGHT HOLDERS BE LIABLE FOR ANY CLAIM, DAMAGES OR OTHER LIABILITY, WHETHER IN AN ACTION OF CONTRACT, TORT OR OTHERWISE, ARISING FROM, OUT OF OR IN CONNECTION WITH THE SOFTWARE OR THE USE OR OTHER DEALINGS IN THE SOFTWARE.

```
# (C) Copyright 2002-2006
# Wolfgang Denk, DENX Software Engineering, wd@denx.de.
#
# See file CREDITS for list of people who contributed to this
# project.
#
# This program is free software; you can redistribute it and/or
# modify it under the terms of the GNU General Public License as
# published by the Free Software Foundation; either version 2 of
# the License, or (at your option) any later version.
#
# This program is distributed in the hope that it will be useful,
# but WITHOUT ANY WARRANTY; without even the implied warranty of
# MERCHANTABILITY or FITNESS FOR A PARTICULAR PURPOSE. See the
# GNU General Public License for more details.
#
# You should have received a copy of the GNU General Public License
# along with this program; if not, write to the Free Software
# Foundation, Inc., 59 Temple Place, Suite 330, Boston,
# MA 02111-1307 USA
#
```

*busybox*

--- A note on GPL versions

BusyBox is distributed under version 2 of the General Public License (included in its entirety, below). Version 2 is the only version of this license which this version of BusyBox (or modified versions derived from this one) may be distributed under.

-----  
GNU GENERAL PUBLIC LICENSE

Version 2, June 1991

Copyright (C) 1989, 1991 Free Software Foundation, Inc.

51 Franklin St, Fifth Floor, Boston, MA 02110-1301 USA

Everyone is permitted to copy and distribute verbatim copies of this license document, but changing it is not allowed.

Preamble

The licenses for most software are designed to take away your freedom to share and change it. By contrast, the GNU General Public License is intended to guarantee your freedom to share and change free software--to make sure the software is free for all its users. This General Public License applies to most of the Free Software Foundation's software and to any other program whose authors commit to using it. (Some other Free Software Foundation software is covered by the GNU Lesser General Public License instead.) You can apply it to your programs, too.

When we speak of free software, we are referring to freedom, not price. Our General Public Licenses are designed to make sure that you have the freedom to distribute copies of free software (and charge for this service if you wish), that you receive source code or can get it if you want it, that you can change the software or use pieces of it in new free programs; and that you know you can do these things.

To protect your rights, we need to make restrictions that forbid anyone to deny you these rights or to ask you to surrender the rights. These restrictions translate to certain responsibilities for you if you distribute copies of the software, or if you modify it.

For example, if you distribute copies of such a program, whether gratis or for a fee, you must give the recipients all the rights that you have. You must make sure that they, too, receive or can get the source code. And you must show them these terms so they know their rights.

We protect your rights with two steps: (1) copyright the software, and (2) offer you this license which gives you legal permission to copy, distribute and/or modify the software.

Also, for each author's protection and ours, we want to make certain that everyone understands that there is no warranty for this free software. If the software is modified by someone else and passed on, we want its recipients to know that what they have is not the original, so that any problems introduced by others will not reflect on the original authors' reputations.

Finally, any free program is threatened constantly by software patents. We wish to avoid the danger that redistributors of a free program will individually obtain patent licenses, in effect making the program proprietary. To prevent this, we have made it clear that any patent must be licensed for everyone's free use or not licensed at all.

The precise terms and conditions for copying, distribution and modification follow.

#### TERMS AND CONDITIONS FOR COPYING, DISTRIBUTION AND MODIFICATION

**0.** This License applies to any program or other work which contains a notice placed by the copyright holder saying it may be distributed under the terms of this General Public License. The "Program", below, refers to any such program or work, and a "work based on the Program" means either the Program or any derivative work under copyright law: that is to say, a work containing the Program or a portion of it, either verbatim or with modifications and/or translated into another language. (Hereinafter, translation is included without limitation in the term "modification".) Each licensee is addressed as "you".

Activities other than copying, distribution and modification are not covered by this License; they are outside its scope. The act of running the Program is not restricted, and the output from the Program is covered only if its contents constitute a work based on the Program (independent of having been made by running the Program). Whether that is true depends on what the Program does.

**1.** You may copy and distribute verbatim copies of the Program's source code as you receive it, in any medium, provided that you conspicuously and appropriately publish on each copy an appropriate copyright notice and disclaimer of warranty; keep intact all the notices that refer to this License and to the absence of any warranty; and give any other recipients of the Program a copy of this License along with the Program.

You may charge a fee for the physical act of transferring a copy, and you may at your option offer warranty protection in exchange for a fee.

**2.** You may modify your copy or copies of the Program or any portion of it, thus forming a work based on the Program, and copy and distribute such modifications or work under the terms of Section 1 above, provided that you also meet all of these conditions:



**a)** You must cause the modified files to carry prominent notices stating that you changed the files and the date of any change.

**b)** You must cause any work that you distribute or publish, that in whole or in part contains or is derived from the Program or any part thereof, to be licensed as a whole at no charge to all third parties under the terms of this License.

**c)** If the modified program normally reads commands interactively when run, you must cause it, when started running for such interactive use in the most ordinary way, to print or display an announcement including an appropriate copyright notice and a notice that there is no warranty (or else, saying that you provide a warranty) and that users may redistribute the program under these conditions, and telling the user how to view a copy of this License.

(Exception: if the Program itself is interactive but does not normally print such an announcement, your work based on the Program is not required to print an announcement.)

These requirements apply to the modified work as a whole. If identifiable sections of that work are not derived from the Program, and can be reasonably considered independent and separate works in themselves, then this License, and its terms, do not apply to those sections when you distribute them as separate works. But when you distribute the same sections as part of a whole which is a work based on the Program, the distribution of the whole must be on the terms of this License, whose permissions for other licensees extend to the entire whole, and thus to each and every part regardless of who wrote it.

Thus, it is not the intent of this section to claim rights or contest your rights to work written entirely by you; rather, the intent is to exercise the right to control the distribution of derivative or collective works based on the Program.

In addition, mere aggregation of another work not based on the Program with the Program (or with a work based on the Program) on a volume of a storage or distribution medium does not bring the other work under the scope of this License.

**3.** You may copy and distribute the Program (or a work based on it, under Section 2) in object code or executable form under the terms of Sections 1 and 2 above provided that you also do one of the following:

- a)** Accompany it with the complete corresponding machine-readable source code, which must be distributed under the terms of Sections 1 and 2 above on a medium customarily used for software interchange; or,
  
- b)** Accompany it with a written offer, valid for at least three years, to give any third party, for a charge no more than your cost of physically performing source distribution, a complete machine-readable copy of the corresponding source code, to be distributed under the terms of Sections 1 and 2 above on a medium customarily used for software interchange; or,
  
- c)** Accompany it with the information you received as to the offer to distribute corresponding source code. (This alternative is allowed only for noncommercial distribution and only if you received the program in object code or executable form with such an offer, in accord with Subsection b above.)

The source code for a work means the preferred form of the work for making modifications to it. For an executable work, complete source code means all the source code for all modules it contains, plus any associated interface definition files, plus the scripts used to control compilation and installation of the executable. However, as a special exception, the source code distributed need not include anything that is normally distributed (in either source or binary form) with the major components (compiler, kernel, and so on) of the operating system on which the executable runs, unless that component itself accompanies the executable.

If distribution of executable or object code is made by offering access to copy from a designated place, then offering equivalent access to copy the source code from the same place counts as distribution of the source code, even though third parties are not compelled to copy the source along with the object code.

**4.** You may not copy, modify, sublicense, or distribute the Program except as expressly provided under this License. Any attempt otherwise to copy, modify, sublicense or distribute the Program is void, and will automatically terminate your rights under this License. However, parties who have received copies, or rights, from you under this License will not have their licenses terminated so long as such parties remain in full compliance.

**5.** You are not required to accept this License, since you have not signed it. However, nothing else grants you permission to modify or distribute the Program or its derivative works. These actions are prohibited by law if you do not accept this License. Therefore, by

modifying or distributing the Program (or any work based on the Program), you indicate your acceptance of this License to do so, and all its terms and conditions for copying, distributing or modifying the Program or works based on it.

**6.** Each time you redistribute the Program (or any work based on the Program), the recipient automatically receives a license from the original licensor to copy, distribute or modify the Program subject to these terms and conditions. You may not impose any further restrictions on the recipients' exercise of the rights granted herein. You are not responsible for enforcing compliance by third parties to this License.

**7.** If, as a consequence of a court judgment or allegation of patent infringement or for any other reason (not limited to patent issues), conditions are imposed on you (whether by court order, agreement or otherwise) that contradict the conditions of this License, they do not excuse you from the conditions of this License. If you cannot distribute so as to satisfy simultaneously your obligations under this License and any other pertinent obligations, then as a consequence you may not distribute the Program at all. For example, if a patent license would not permit royalty-free redistribution of the Program by all those who receive copies directly or indirectly through you, then the only way you could satisfy both it and this License would be to refrain entirely from distribution of the Program.

If any portion of this section is held invalid or unenforceable under any particular circumstance, the balance of the section is intended to apply and the section as a whole is intended to apply in other circumstances.

It is not the purpose of this section to induce you to infringe any patents or other property right claims or to contest validity of any such claims; this section has the sole purpose of protecting the integrity of the free software distribution system, which is implemented by public license practices. Many people have made generous contributions to the wide range of software distributed through that system in reliance on consistent application of that system; it is up to the author/donor to decide if he or she is willing to distribute software through any other system and a licensee cannot impose that choice.

This section is intended to make thoroughly clear what is believed to be a consequence of the rest of this License.

**8.** If the distribution and/or use of the Program is restricted in certain countries either by patents or by copyrighted interfaces, the original copyright holder who places the Program under this License may add an explicit geographical distribution limitation excluding those countries, so that distribution is permitted only in or among countries not thus excluded. In such case, this License incorporates the limitation as if written in the body of this License.

9. The Free Software Foundation may publish revised and/or new versions of the General Public License from time to time. Such new versions will be similar in spirit to the present version, but may differ in detail to address new problems or concerns.

Each version is given a distinguishing version number. If the Program specifies a version number of this License which applies to it and "any later version", you have the option of following the terms and conditions either of that version or of any later version published by the Free Software Foundation. If the Program does not specify a version number of this License, you may choose any version ever published by the Free Software Foundation.

10. If you wish to incorporate parts of the Program into other free programs whose distribution conditions are different, write to the author to ask for permission. For software which is copyrighted by the Free Software Foundation, write to the Free Software Foundation; we sometimes make exceptions for this. Our decision will be guided by the two goals of preserving the free status of all derivatives of our free software and of promoting the sharing and reuse of software generally.

#### **NO WARRANTY**

11. BECAUSE THE PROGRAM IS LICENSED FREE OF CHARGE, THERE IS NO WARRANTY FOR THE PROGRAM, TO THE EXTENT PERMITTED BY APPLICABLE LAW. EXCEPT WHEN OTHERWISE STATED IN WRITING THE COPYRIGHT HOLDERS AND/OR OTHER PARTIES PROVIDE THE PROGRAM "AS IS" WITHOUT WARRANTY OF ANY KIND, EITHER EXPRESSED OR IMPLIED, INCLUDING, BUT NOT LIMITED TO, THE IMPLIED WARRANTIES OF MERCHANTABILITY AND FITNESS FOR A PARTICULAR PURPOSE. THE ENTIRE RISK AS TO THE QUALITY AND PERFORMANCE OF THE PROGRAM IS WITH YOU. SHOULD THE PROGRAM PROVE DEFECTIVE, YOU ASSUME THE COST OF ALL NECESSARY SERVICING, REPAIR OR CORRECTION.

12. IN NO EVENT UNLESS REQUIRED BY APPLICABLE LAW OR AGREED TO IN WRITING WILL ANY COPYRIGHT HOLDER, OR ANY OTHER PARTY WHO MAY MODIFY AND/OR REDISTRIBUTE THE PROGRAM AS PERMITTED ABOVE, BE LIABLE TO YOU FOR DAMAGES, INCLUDING ANY GENERAL, SPECIAL, INCIDENTAL OR CONSEQUENTIAL DAMAGES ARISING OUT OF THE USE OR INABILITY TO USE THE PROGRAM (INCLUDING BUT NOT LIMITED TO LOSS OF DATA OR DATA BEING RENDERED INACCURATE OR LOSSES SUSTAINED BY YOU OR THIRD PARTIES OR A FAILURE OF THE PROGRAM TO OPERATE WITH ANY OTHER PROGRAMS), EVEN IF SUCH HOLDER OR OTHER PARTY HAS BEEN ADVISED OF THE POSSIBILITY OF SUCH DAMAGES.

END OF TERMS AND CONDITIONS

# (C) Copyright 2002-2006

```
# Wolfgang Denk, DENX Software Engineering, wd@denx.de.  
#  
# See file CREDITS for list of people who contributed to this  
# project.  
#  
# This program is free software; you can redistribute it and/or  
# modify it under the terms of the GNU General Public License as  
# published by the Free Software Foundation; either version 2 of  
# the License, or (at your option) any later version.  
#  
# This program is distributed in the hope that it will be useful,  
# but WITHOUT ANY WARRANTY; without even the implied warranty of  
# MERCHANTABILITY or FITNESS FOR A PARTICULAR PURPOSE. See the  
# GNU General Public License for more details.  
#  
# You should have received a copy of the GNU General Public License  
# along with this program; if not, write to the Free Software  
# Foundation, Inc., 59 Temple Place, Suite 330, Boston,  
# MA 02111-1307 USA  
#
```

---

*dnsmasq*

```
# This program is free software; you can redistribute it and/or modify  
# it under the terms of the GNU General Public License as published by  
# the Free Software Foundation; version 2 dated June, 1991, or  
# (at your option) version 3 dated 29 June, 2007.
```

See full license text on page [335](#).

```
# (C) Copyright 2002-2006  
# Wolfgang Denk, DENX Software Engineering, wd@denx.de.  
#  
# See file CREDITS for list of people who contributed to this  
# project.  
#  
# This program is free software; you can redistribute it and/or  
# modify it under the terms of the GNU General Public License as  
# published by the Free Software Foundation; either version 2 of  
# the License, or (at your option) any later version.  
#  
# This program is distributed in the hope that it will be useful,  
# but WITHOUT ANY WARRANTY; without even the implied warranty of  
# MERCHANTABILITY or FITNESS FOR A PARTICULAR PURPOSE. See the  
# GNU General Public License for more details.  
#  
# You should have received a copy of the GNU General Public License  
# along with this program; if not, write to the Free Software  
# Foundation, Inc., 59 Temple Place, Suite 330, Boston,  
# MA 02111-1307 USA  
#
```

*dropbear*

Dropbear contains a number of components from different sources, hence there are a few licenses and authors involved. All licenses are fairly non-restrictive.

The majority of code is written by Matt Johnston, under the license below. Portions of the client-mode work are (c) 2004 Mihnea Stoenescu, under the same license:

Copyright (c) 2002-2008 Matt Johnston  
Portions copyright (c) 2004 Mihnea Stoenescu  
All rights reserved.

Permission is hereby granted, free of charge, to any person obtaining a copy of this software and associated documentation files (the "Software"), to deal in the Software without restriction, including without limitation the rights to use, copy, modify, merge, publish, distribute, sublicense, and/or sell copies of the Software, and to permit persons to whom the Software is furnished to do so, subject to the following conditions:

The above copyright notice and this permission notice shall be included in all copies or substantial portions of the Software.

THE SOFTWARE IS PROVIDED "AS IS", WITHOUT WARRANTY OF ANY KIND, EXPRESS OR IMPLIED, INCLUDING BUT NOT LIMITED TO THE WARRANTIES OF MERCHANTABILITY, FITNESS FOR A PARTICULAR PURPOSE AND NONINFRINGEMENT. IN NO EVENT SHALL THE AUTHORS OR COPYRIGHT HOLDERS BE LIABLE FOR ANY CLAIM, DAMAGES OR OTHER LIABILITY, WHETHER IN AN ACTION OF CONTRACT, TORT OR OTHERWISE, ARISING FROM, OUT OF OR IN CONNECTION WITH THE SOFTWARE OR THE USE OR OTHER DEALINGS IN THE SOFTWARE.

=====

LibTomCrypt and LibTomMath are written by Tom St Denis, and are Public Domain.

=====

sshpty.c is taken from OpenSSH 3.5p1,  
Copyright (c) 1995 Tatu Ylonen <ylo@cs.hut.fi>, Espoo, Finland  
All rights reserved

"As far as I am concerned, the code I have written for this software can be used freely for any purpose. Any derived versions of this software must be clearly marked as such, and if the derived work is incompatible with the protocol description in the RFC file, it must be called by a name other than "ssh" or "Secure Shell". "

```
=====
```

```
loginrec.c
```

```
loginrec.h
```

```
atomicio.h
```

```
atomicio.c
```

```
and strlcat() (included in util.c) are from OpenSSH 3.6.1p2, and are licensed under the 2 point BSD license.
```

```
loginrec is written primarily by Andre Lucas, atomicio.c by Theo de Raadt.
```

```
strlcat() is (c) Todd C. Miller
```

```
=====
```

```
Import code in keyimport.c is modified from PuTTY's import.c, licensed as follows:
```

```
PuTTY is copyright 1997-2003 Simon Tatham.
```

```
Portions copyright Robert de Bath, Joris van Rantwijk, Delian Delchev, Andreas Schultz, Jeroen Massar, Wez Furlong, Nicolas Barry, Justin Bradford, and CORE SDI S.A.
```

```
Permission is hereby granted, free of charge, to any person obtaining a copy of this software and associated documentation files (the "Software"), to deal in the Software without restriction, including without limitation the rights to use, copy, modify, merge, publish, distribute, sublicense, and/or sell copies of the Software, and to permit persons to whom the Software is furnished to do so, subject to the following conditions:
```

```
The above copyright notice and this permission notice shall be included in all copies or substantial portions of the Software.
```

```
THE SOFTWARE IS PROVIDED "AS IS", WITHOUT WARRANTY OF ANY KIND, EXPRESS OR IMPLIED, INCLUDING BUT NOT LIMITED TO THE WARRANTIES OF MERCHANTABILITY, FITNESS FOR A PARTICULAR PURPOSE AND NONINFRINGEMENT. IN NO EVENT SHALL THE COPYRIGHT HOLDERS BE LIABLE FOR ANY CLAIM, DAMAGES OR OTHER LIABILITY, WHETHER IN AN ACTION OF CONTRACT, TORT OR OTHERWISE, ARISING FROM, OUT OF OR IN CONNECTION WITH THE SOFTWARE OR THE USE OR OTHER DEALINGS IN THE SOFTWARE.
```

```
# (C) Copyright 2002-2006
```

```
# Wolfgang Denk, DENX Software Engineering, wd@denx.de.
```

```
#
```

```
# See file CREDITS for list of people who contributed to this
```

	<pre> # project. # # This program is free software; you can redistribute it and/or # modify it under the terms of the GNU General Public License as # published by the Free Software Foundation; either version 2 of # the License, or (at your option) any later version. # # This program is distributed in the hope that it will be useful, # but WITHOUT ANY WARRANTY; without even the implied warranty of # MERCHANTABILITY or FITNESS FOR A PARTICULAR PURPOSE. See the # GNU General Public License for more details. # # You should have received a copy of the GNU General Public License # along with this program; if not, write to the Free Software # Foundation, Inc., 59 Temple Place, Suite 330, Boston, # MA 02111-1307 USA # </pre>
<i>ebtables</i>	<p>Copyright (C) 1999 Paul 'Rusty' Russell &amp; Michael J. Neuling  Copyright (C) 2001-2002 Bart De Schuymer</p> <p>All code in this package, including the code from the extensions,  is released under the GPL license, which you find hereafter.</p> <p style="text-align: center;">GNU GENERAL PUBLIC LICENSE  Version 2, June 1991</p> <p>Copyright (C) 1989, 1991 Free Software Foundation, Inc.  675 Mass Ave, Cambridge, MA 02139, USA  Everyone is permitted to copy and distribute verbatim copies  of this license document, but changing it is not allowed.</p> <p>See full license text on page <a href="#">335</a>.</p> <pre> # (C) Copyright 2002-2006 # Wolfgang Denk, DENX Software Engineering, wd@denx.de. # # See file CREDITS for list of people who contributed to this # project. # # This program is free software; you can redistribute it and/or # modify it under the terms of the GNU General Public License as # published by the Free Software Foundation; either version 2 of # the License, or (at your option) any later version. # # This program is distributed in the hope that it will be useful, # but WITHOUT ANY WARRANTY; without even the implied warranty of # MERCHANTABILITY or FITNESS FOR A PARTICULAR PURPOSE. See the # GNU General Public License for more details. # # You should have received a copy of the GNU General Public License </pre>



	<pre># along with this program; if not, write to the Free Software # Foundation, Inc., 59 Temple Place, Suite 330, Boston, # MA 02111-1307 USA #</pre>
<i>eventlog</i>	<p>Copyright (c) 2003 BalaBit IT Ltd.</p> <p>Redistribution and use in source and binary forms, with or without modification, are permitted provided that the following conditions are met:</p> <ol style="list-style-type: none"><li>1. Redistributions of source code must retain the above copyright notice, this list of conditions and the following disclaimer.</li><li>2. Redistributions in binary form must reproduce the above copyright notice, this list of conditions and the following disclaimer in the documentation and/or other materials provided with the distribution.</li><li>3. Neither the name of BalaBit nor the names of its contributors may be used to endorse or promote products derived from this software without specific prior written permission.</li></ol> <p>THIS SOFTWARE IS PROVIDED BY BALABIT AND CONTRIBUTORS ``AS IS" AND ANY EXPRESS OR IMPLIED WARRANTIES, INCLUDING, BUT NOT LIMITED TO, THE IMPLIED WARRANTIES OF MERCHANTABILITY AND FITNESS FOR A PARTICULAR PURPOSE ARE DISCLAIMED. IN NO EVENT SHALL THE AUTHOR OR CONTRIBUTORS BE LIABLE FOR ANY DIRECT, INDIRECT, INCIDENTAL, SPECIAL, EXEMPLARY, OR CONSEQUENTIAL DAMAGES (INCLUDING, BUT NOT LIMITED TO, PROCUREMENT OF SUBSTITUTE GOODS OR SERVICES; LOSS OF USE, DATA, OR PROFITS; OR BUSINESS INTERRUPTION) HOWEVER CAUSED AND ON ANY THEORY OF LIABILITY, WHETHER IN CONTRACT, STRICT LIABILITY, OR TORT (INCLUDING NEGLIGENCE OR OTHERWISE) ARISING IN ANY WAY OUT OF THE USE OF THIS SOFTWARE, EVEN IF ADVISED OF THE POSSIBILITY OF SUCH DAMAGE.</p> <pre># (C) Copyright 2002-2006 # Wolfgang Denk, DENX Software Engineering, wd@denx.de. # # See file CREDITS for list of people who contributed to this # project. # # This program is free software; you can redistribute it and/or # modify it under the terms of the GNU General Public License as # published by the Free Software Foundation; either version 2 of # the License, or (at your option) any later version. # # This program is distributed in the hope that it will be useful, # but WITHOUT ANY WARRANTY; without even the implied warranty of # MERCHANTABILITY or FITNESS FOR A PARTICULAR PURPOSE. See the # GNU General Public License for more details. # # You should have received a copy of the GNU General Public License</pre>

	<pre># along with this program; if not, write to the Free Software # Foundation, Inc., 59 Temple Place, Suite 330, Boston, # MA 02111-1307 USA #</pre>
<i>firewall</i>	<pre># Copyright (C) 2009-2010 OpenWrt.org  # (C) Copyright 2002-2006 # Wolfgang Denk, DENX Software Engineering, wd@denx.de. # # See file CREDITS for list of people who contributed to this # project. # # This program is free software; you can redistribute it and/or # modify it under the terms of the GNU General Public License as # published by the Free Software Foundation; either version 2 of # the License, or (at your option) any later version. # # This program is distributed in the hope that it will be useful, # but WITHOUT ANY WARRANTY; without even the implied warranty of # MERCHANTABILITY or FITNESS FOR A PARTICULAR PURPOSE. See the # GNU General Public License for more details. # # You should have received a copy of the GNU General Public License # along with this program; if not, write to the Free Software # Foundation, Inc., 59 Temple Place, Suite 330, Boston, # MA 02111-1307 USA #</pre>
<i>glib2</i>	<pre>Copyright (C) 2007-2011 OpenWrt.org Copyright (C) 1994, 1995, 1996, 1997, 1998, 1999, 2000, 2001, 2002, 2003, 2004, 2005, 2006, 2007, 2008, 2009 Free Software Foundation, Inc. Copyright © 2004 Scott James Remnant &lt;scott@netsplit.com&gt;. Copyright (c) 1997-2006 University of Cambridge. Copyright © 2009 Codethink Limited Copyright (C) 2008-2010 Red Hat, Inc. Copyright (C) 2008 Hans Breuer Copyright (C) 2008, 2010 Collabora, Ltd.  GNU LIBRARY GENERAL PUBLIC LICENSE Version 2, June 1991  Copyright (C) 1991 Free Software Foundation, Inc. 59 Temple Place, Suite 330, Boston, MA 02111-1307 USA Everyone is permitted to copy and distribute verbatim copies of this license document, but changing it is not allowed.  [This is the first released version of the library GPL. It is numbered 2 because it goes with version 2 of the ordinary GPL.]</pre>

See full license text on page 335.

```
# (C) Copyright 2002-2006
# Wolfgang Denk, DENX Software Engineering, wd@denx.de.
#
# See file CREDITS for list of people who contributed to this
# project.
#
# This program is free software; you can redistribute it and/or
# modify it under the terms of the GNU General Public License as
# published by the Free Software Foundation; either version 2 of
# the License, or (at your option) any later version.
#
# This program is distributed in the hope that it will be useful,
# but WITHOUT ANY WARRANTY; without even the implied warranty of
# MERCHANTABILITY or FITNESS FOR A PARTICULAR PURPOSE. See the
# GNU General Public License for more details.
#
# You should have received a copy of the GNU General Public License
# along with this program; if not, write to the Free Software
# Foundation, Inc., 59 Temple Place, Suite 330, Boston,
# MA 02111-1307 USA
#
```

---

*hostapd*

Copyright (c) 2002-2011, Jouni Malinen <j@w1.fi> and contributors  
All Rights Reserved.

These programs are dual-licensed under both the GPL version 2 and BSD  
license (the one with advertisement clause removed). Either license  
may be used at your option.

This package may include either wpa\_supplicant, hostapd, or both. See  
README file respective subdirectories (wpa\_supplicant/README or  
hostapd/README) for more details.

See full license text on page 335.

```
# (C) Copyright 2002-2006
# Wolfgang Denk, DENX Software Engineering, wd@denx.de.
#
# See file CREDITS for list of people who contributed to this
# project.
#
# This program is free software; you can redistribute it and/or
# modify it under the terms of the GNU General Public License as
# published by the Free Software Foundation; either version 2 of
# the License, or (at your option) any later version.
#
# This program is distributed in the hope that it will be useful,
# but WITHOUT ANY WARRANTY; without even the implied warranty of
# MERCHANTABILITY or FITNESS FOR A PARTICULAR PURPOSE. See the
# GNU General Public License for more details.
```

	<pre># # You should have received a copy of the GNU General Public License # along with this program; if not, write to the Free Software # Foundation, Inc., 59 Temple Place, Suite 330, Boston, # MA 02111-1307 USA #</pre>
<i>hotplug</i>	<pre>GNU GENERAL PUBLIC LICENSE Version 2, June 1991  See full license text on page 335.  # (C) Copyright 2002-2006 # Wolfgang Denk, DENX Software Engineering, wd@denx.de. # # See file CREDITS for list of people who contributed to this # project. # # This program is free software; you can redistribute it and/or # modify it under the terms of the GNU General Public License as # published by the Free Software Foundation; either version 2 of # the License, or (at your option) any later version. # # This program is distributed in the hope that it will be useful, # but WITHOUT ANY WARRANTY; without even the implied warranty of # MERCHANTABILITY or FITNESS FOR A PARTICULAR PURPOSE. See the # GNU General Public License for more details. # # You should have received a copy of the GNU General Public License # along with this program; if not, write to the Free Software # Foundation, Inc., 59 Temple Place, Suite 330, Boston, # MA 02111-1307 USA #</pre>
<i>iperf</i>	<pre>Copyright 1999, 2000, 2001, 2002, 2003, 2004 The Board of Trustees of the University of Illinois All rights reserved  Permission is hereby granted, free of charge, to any person obtaining a copy of this software (Iperf) and associated documentation files (the "Software"), to deal in the Software without restriction, including without limitation the rights to use, copy, modify, merge, publish, distribute, sublicense, and/or sell copies of the Software, and to permit persons to whom the Software is furnished to do so, subject to the following conditions:  Redistributions of source code must retain the above copyright notice, this list of</pre>

conditions and the following disclaimers.  
 Redistributions in binary form must reproduce the above copyright notice, this list of conditions and the following disclaimers in the documentation and/or other materials provided with the distribution.  
 Neither the names of the University of Illinois, NCSA, nor the names of its contributors may be used to endorse or promote products derived from this Software without specific prior written permission.  
 THE SOFTWARE IS PROVIDED "AS IS", WITHOUT WARRANTY OF ANY KIND, EXPRESS OR IMPLIED, INCLUDING BUT NOT LIMITED TO THE WARRANTIES OF MERCHANTABILITY, FITNESS FOR A PARTICULAR PURPOSE AND NONINFRINGEMENT. IN NO EVENT SHALL THE CONTRIBUTORS OR COPYRIGHT HOLDERS BE LIABLE FOR ANY CLAIM, DAMAGES OR OTHER LIABILITY, WHETHER IN AN ACTION OF CONTRACT, TORT OR OTHERWISE, ARISING FROM, OUT OF OR IN CONNECTION WITH THE SOFTWARE OR THE USE OR OTHER DEALINGS IN THE SOFTWARE.

```
# (C) Copyright 2002-2006
# Wolfgang Denk, DENX Software Engineering, wd@denx.de.
#
# See file CREDITS for list of people who contributed to this
# project.
#
# This program is free software; you can redistribute it and/or
# modify it under the terms of the GNU General Public License as
# published by the Free Software Foundation; either version 2 of
# the License, or (at your option) any later version.
#
# This program is distributed in the hope that it will be useful,
# but WITHOUT ANY WARRANTY; without even the implied warranty of
# MERCHANTABILITY or FITNESS FOR A PARTICULAR PURPOSE. See the
# GNU General Public License for more details.
#
# You should have received a copy of the GNU General Public License
# along with this program; if not, write to the Free Software
# Foundation, Inc., 59 Temple Place, Suite 330, Boston,
# MA 02111-1307 USA
#
```

*iproute2*

GNU GENERAL PUBLIC LICENSE  
 Version 2, June 1991

Copyright (C) 1989, 1991 Free Software Foundation, Inc.  
 51 Franklin St, Fifth Floor, Boston, MA 02110-1301 USA  
 Everyone is permitted to copy and distribute verbatim copies  
 of this license document, but changing it is not allowed.

See full license text on page [335](#).

```
# (C) Copyright 2002-2006
# Wolfgang Denk, DENX Software Engineering, wd@denx.de.
```

```
#
# See file CREDITS for list of people who contributed to this
# project.
#
# This program is free software; you can redistribute it and/or
# modify it under the terms of the GNU General Public License as
# published by the Free Software Foundation; either version 2 of
# the License, or (at your option) any later version.
#
# This program is distributed in the hope that it will be useful,
# but WITHOUT ANY WARRANTY; without even the implied warranty of
# MERCHANTABILITY or FITNESS FOR A PARTICULAR PURPOSE. See the
# GNU General Public License for more details.
#
# You should have received a copy of the GNU General Public License
# along with this program; if not, write to the Free Software
# Foundation, Inc., 59 Temple Place, Suite 330, Boston,
# MA 02111-1307 USA
#
```

*iptables*

GNU GENERAL PUBLIC LICENSE  
Version 2, June 1991

Copyright (C) 1989, 1991 Free Software Foundation, Inc.  
675 Mass Ave, Cambridge, MA 02139, USA  
Everyone is permitted to copy and distribute verbatim copies  
of this license document, but changing it is not allowed.

See full license text on page [335](#).

```
# (C) Copyright 2002-2006
# Wolfgang Denk, DENX Software Engineering, wd@denx.de.
#
# See file CREDITS for list of people who contributed to this
# project.
#
# This program is free software; you can redistribute it and/or
# modify it under the terms of the GNU General Public License as
# published by the Free Software Foundation; either version 2 of
# the License, or (at your option) any later version.
#
# This program is distributed in the hope that it will be useful,
# but WITHOUT ANY WARRANTY; without even the implied warranty of
# MERCHANTABILITY or FITNESS FOR A PARTICULAR PURPOSE. See the
# GNU General Public License for more details.
#
# You should have received a copy of the GNU General Public License
# along with this program; if not, write to the Free Software
# Foundation, Inc., 59 Temple Place, Suite 330, Boston,
# MA 02111-1307 USA
#
```

*iputils*

```
/*
 * Copyright (c) 1989 The Regents of the University of California.
 * All rights reserved.
 *
 * This code is derived from software contributed to Berkeley by
 * Mike Muuss.
 *
 * Redistribution and use in source and binary forms, with or without
 * modification, are permitted provided that the following conditions
 * are met:
 * 1. Redistributions of source code must retain the above copyright
 * notice, this list of conditions and the following disclaimer.
 * 2. Redistributions in binary form must reproduce the above copyright
 * notice, this list of conditions and the following disclaimer in the
 * documentation and/or other materials provided with the distribution.
 * 3. All advertising materials mentioning features or use of this software
 * must display the following acknowledgement:
 * This product includes software developed by the University of
 * California, Berkeley and its contributors.
 * 4. Neither the name of the University nor the names of its contributors
 * may be used to endorse or promote products derived from this software
 * without specific prior written permission.
 *
 * THIS SOFTWARE IS PROVIDED BY THE REGENTS AND CONTRIBUTORS ``AS IS''
 AND ANY EXPRESS OR IMPLIED WARRANTIES, INCLUDING, BUT NOT LIMITED TO,
 THE IMPLIED WARRANTIES OF MERCHANTABILITY AND FITNESS FOR A
 PARTICULAR PURPOSE ARE DISCLAIMED. IN NO EVENT SHALL THE REGENTS OR
 CONTRIBUTORS BE LIABLE FOR ANY DIRECT, INDIRECT, INCIDENTAL, SPECIAL,
 EXEMPLARY, OR CONSEQUENTIAL DAMAGES (INCLUDING, BUT NOT LIMITED TO,
 PROCUREMENT OF SUBSTITUTE GOODS OR SERVICES; LOSS OF USE, DATA, OR
 PROFITS; OR BUSINESS INTERRUPTION) HOWEVER CAUSED AND ON ANY THEORY
 OF LIABILITY, WHETHER IN CONTRACT, STRICT LIABILITY, OR TORT (INCLUDING
 NEGLIGENCE OR OTHERWISE) ARISING IN ANY WAY OUT OF THE USE OF THIS
 SOFTWARE, EVEN IF ADVISED OF THE POSSIBILITY OF SUCH DAMAGE.
 */

# (C) Copyright 2002-2006
# Wolfgang Denk, DENX Software Engineering, wd@denx.de.
#
# See file CREDITS for list of people who contributed to this
# project.
#
# This program is free software; you can redistribute it and/or
# modify it under the terms of the GNU General Public License as
# published by the Free Software Foundation; either version 2 of
# the License, or (at your option) any later version.
#
# This program is distributed in the hope that it will be useful,
```

---

	<pre># but WITHOUT ANY WARRANTY; without even the implied warranty of # MERCHANTABILITY or FITNESS FOR A PARTICULAR PURPOSE. See the # GNU General Public License for more details. # # You should have received a copy of the GNU General Public License # along with this program; if not, write to the Free Software # Foundation, Inc., 59 Temple Place, Suite 330, Boston, # MA 02111-1307 USA #</pre>
<b>Button-hotplug</b>	<pre>Copyright (C) 2008 Gabor Juhas &lt;juhasg@openwrt.org&gt;  Based on the diag.c - GPIO interface driver for Broadcom boards Copyright (C) 2006 Mike Baker &lt;mbm@openwrt.org&gt;, Copyright (C) 2006-2007 Felix Fietkau &lt;nbd@openwrt.org&gt; Copyright (C) 2008 Andy Boyett &lt;agb@openwrt.org&gt;  GPL v2  See full license text on page <a href="#">335</a>.  # (C) Copyright 2002-2006 # Wolfgang Denk, DENX Software Engineering, wd@denx.de. # # See file CREDITS for list of people who contributed to this # project. # # This program is free software; you can redistribute it and/or # modify it under the terms of the GNU General Public License as # published by the Free Software Foundation; either version 2 of # the License, or (at your option) any later version. # # This program is distributed in the hope that it will be useful, # but WITHOUT ANY WARRANTY; without even the implied warranty of # MERCHANTABILITY or FITNESS FOR A PARTICULAR PURPOSE. See the # GNU General Public License for more details. # # You should have received a copy of the GNU General Public License # along with this program; if not, write to the Free Software # Foundation, Inc., 59 Temple Place, Suite 330, Boston, # MA 02111-1307 USA #</pre>



*libdbi*

GNU LESSER GENERAL PUBLIC LICENSE  
Version 2.1, February 1999

Copyright (C) 1991, 1999 Free Software Foundation, Inc.  
59 Temple Place, Suite 330, Boston, MA 02111-1307 USA  
Everyone is permitted to copy and distribute verbatim copies  
of this license document, but changing it is not allowed.

[This is the first released version of the Lesser GPL. It also counts  
as the successor of the GNU Library Public License, version 2, hence  
the version number 2.1.]

See full license text on page [357](#).

```
# (C) Copyright 2002-2006
# Wolfgang Denk, DENX Software Engineering, wd@denx.de.
#
# See file CREDITS for list of people who contributed to this
# project.
#
# This program is free software; you can redistribute it and/or
# modify it under the terms of the GNU General Public License as
# published by the Free Software Foundation; either version 2 of
# the License, or (at your option) any later version.
#
# This program is distributed in the hope that it will be useful,
# but WITHOUT ANY WARRANTY; without even the implied warranty of
# MERCHANTABILITY or FITNESS FOR A PARTICULAR PURPOSE. See the
# GNU General Public License for more details.
#
# You should have received a copy of the GNU General Public License
# along with this program; if not, write to the Free Software
# Foundation, Inc., 59 Temple Place, Suite 330, Boston,
# MA 02111-1307 USA
#
```

*libiconv*

```
# Copyright (C) 1996, 1997, 1998, 1999, 2000, 2001, 2002, 2003, 2004,
# 2005 Free Software Foundation, Inc.
/* Copyright (C) 1992,1995-1999,2000-2002,2005-2006 Free Software
Foundation, Inc.
This file is part of the GNU C Library.

/* Copyright (C) 1999-2001, 2003 Bruno Haible.
This file is not part of the GNU LIBICONV Library. This file is put into the public
domain. */

/*
* Copyright (C) 1999-2001, 2005 Free Software Foundation, Inc.
* This file is part of the GNU LIBICONV Library.
```

```
*
* The GNU LIBICONV Library is free software; you can redistribute it
* and/or modify it under the terms of the GNU Library General Public
* License as published by the Free Software Foundation; either version 2
* of the License, or (at your option) any later version.
*
* The GNU LIBICONV Library is distributed in the hope that it will be
* useful, but WITHOUT ANY WARRANTY; without even the implied warranty of
* MERCHANTABILITY or FITNESS FOR A PARTICULAR PURPOSE. See the GNU
* Library General Public License for more details.
*/
/* Copyright (C) 1999-2004, 2006 Free Software Foundation, Inc.
   This file is part of the GNU LIBICONV Tools.

   This program is free software; you can redistribute it and/or modify
   it under the terms of the GNU General Public License as published by
   the Free Software Foundation; either version 2, or (at your option)
   any later version.

   This program is distributed in the hope that it will be useful,
   but WITHOUT ANY WARRANTY; without even the implied warranty of
   MERCHANTABILITY or FITNESS FOR A PARTICULAR PURPOSE. See the
   GNU General Public License for more details.
*/
/* Copyright (C) 2000-2003 Free Software Foundation, Inc.
   This file is part of the GNU CHARSET Library.

   This program is free software; you can redistribute it and/or modify it
   under the terms of the GNU Library General Public License as published
   by the Free Software Foundation; either version 2, or (at your option)
   any later version.
*/
# This originates from X11R5 (mit/util/scripts/install.sh), which was
# later released in X11R6 (xc/config/util/install.sh) with the
# following copyright and license.
#
# Copyright (C) 1994 X Consortium
#
# Permission is hereby granted, free of charge, to any person obtaining a copy
# of this software and associated documentation files (the "Software"), to
# deal in the Software without restriction, including without limitation the
# rights to use, copy, modify, merge, publish, distribute, sublicense, and/or
# sell copies of the Software, and to permit persons to whom the Software is
# furnished to do so, subject to the following conditions:
#
# The above copyright notice and this permission notice shall be included in
```

```
# all copies or substantial portions of the Software.
#
# THE SOFTWARE IS PROVIDED "AS IS", WITHOUT WARRANTY OF ANY KIND,
EXPRESS OR
# IMPLIED, INCLUDING BUT NOT LIMITED TO THE WARRANTIES OF
MERCHANTABILITY,
# FITNESS FOR A PARTICULAR PURPOSE AND NONINFRINGEMENT. IN NO EVENT
SHALL THE
# X CONSORTIUM BE LIABLE FOR ANY CLAIM, DAMAGES OR OTHER LIABILITY,
WHETHER IN
# AN ACTION OF CONTRACT, TORT OR OTHERWISE, ARISING FROM, OUT OF OR IN
CONNEC-
# TION WITH THE SOFTWARE OR THE USE OR OTHER DEALINGS IN THE
SOFTWARE.
#
# Except as contained in this notice, the name of the X Consortium shall not
# be used in advertising or otherwise to promote the sale, use or other deal-
# ings in this Software without prior written authorization from the X Consor-
# tium.
#
#
# FSF changes to this file are in the public domain.
#
# Calling this script install-sh is preferred over install.sh, to prevent
# `make' implicit rules from creating a file called install from it
# when there is no Makefile.
#
# This script is compatible with the BSD install script, but was written
# from scratch. It can only install one file at a time, a restriction
# shared with many OS's install programs.

See full license text on page 335.

# (C) Copyright 2002-2006
# Wolfgang Denk, DENX Software Engineering, wd@denx.de.
#
# See file CREDITS for list of people who contributed to this
# project.
#
# This program is free software; you can redistribute it and/or
# modify it under the terms of the GNU General Public License as
# published by the Free Software Foundation; either version 2 of
# the License, or (at your option) any later version.
#
# This program is distributed in the hope that it will be useful,
# but WITHOUT ANY WARRANTY; without even the implied warranty of
# MERCHANTABILITY or FITNESS FOR A PARTICULAR PURPOSE. See the
# GNU General Public License for more details.
```

	<pre># # You should have received a copy of the GNU General Public License # along with this program; if not, write to the Free Software # Foundation, Inc., 59 Temple Place, Suite 330, Boston, # MA 02111-1307 USA #</pre>
<i>libiwinfo</i>	<pre>Copyright (C) 2010-2012 Jo-Philipp Wich &lt;xm@subsignal.org&gt; Copyright (C) 2003-2004 Greg Kroah-Hartman &lt;greg@kroah.com&gt; Copyright (C) 2004-2006 Kay Sievers &lt;kay.sievers@vrfy.org&gt; Copyright (C) 2004 Harald Hoyer &lt;harald@redhat.com&gt; Copyright (C) 2004 Harald Hoyer &lt;harald@redhat.com&gt; Copyright (c) 2001 Atsushi Onoe Copyright (c) 2002-2005 Sam Leffler, Errno Consulting Copyright (c) 1997-2007 Jean Tourrilhes, All Rights Reserved. Copyright 2008 Michael Buesch &lt;mb@bu3sch.de&gt; Copyright 2008, 2009 Luis R. Rodriguez &lt;lrodriguez@atheros.com&gt; Copyright 2008 Jouni Malinen &lt;jouni.malinen@atheros.com&gt; Copyright 2008 Colin McCabe &lt;colin@cozybit.com&gt; Copyright 2006, Broadcom Corporation Copyright 2006-2010 Johannes Berg &lt;johannes@sipsolutions.net&gt;  /*  * iwinfo - Wireless Information Library - Command line frontend  *  * Copyright (C) 2011 Jo-Philipp Wich &lt;xm@subsignal.org&gt;  *  * The iwinfo library is free software: you can redistribute it and/or  * modify it under the terms of the GNU General Public License version 2  * as published by the Free Software Foundation.  *  * The iwinfo library is distributed in the hope that it will be useful,  * but WITHOUT ANY WARRANTY; without even the implied warranty of  * MERCHANTABILITY or FITNESS FOR A PARTICULAR PURPOSE.  * See the GNU General Public License for more details.  *  * You should have received a copy of the GNU General Public License along  * with the iwinfo library. If not, see http://www.gnu.org/licenses/.  */  See full license text on page 335.  # (C) Copyright 2002-2006 # Wolfgang Denk, DENX Software Engineering, wd@denx.de. # # See file CREDITS for list of people who contributed to this # project. # # This program is free software; you can redistribute it and/or # modify it under the terms of the GNU General Public License as</pre>

```
# published by the Free Software Foundation; either version 2 of
# the License, or (at your option) any later version.
#
# This program is distributed in the hope that it will be useful,
# but WITHOUT ANY WARRANTY; without even the implied warranty of
# MERCHANTABILITY or FITNESS FOR A PARTICULAR PURPOSE. See the
# GNU General Public License for more details.
#
# You should have received a copy of the GNU General Public License
# along with this program; if not, write to the Free Software
# Foundation, Inc., 59 Temple Place, Suite 330, Boston,
# MA 02111-1307 USA
#
```

*Libnl-tiny*

LGPLv2.1

```
/*
 * lib/attr.c      Netlink Attributes
 *
 * This library is free software; you can redistribute it and/or
 * modify it under the terms of the GNU Lesser General Public
 * License as published by the Free Software Foundation version 2.1
 * of the License.
 *
 * Copyright (c) 2003-2008 Thomas Graf <tgraf@suug.ch>
 */
```

GNU LESSER GENERAL PUBLIC LICENSE

Version 2.1, February 1999

Copyright (C) 1991, 1999 Free Software Foundation, Inc.

51 Franklin Street, Fifth Floor, Boston, MA 02110-1301 USA

Everyone is permitted to copy and distribute verbatim copies  
of this license document, but changing it is not allowed.

[This is the first released version of the Lesser GPL. It also counts  
as the successor of the GNU Library Public License, version 2, hence  
the version number 2.1.]

Preamble

The licenses for most software are designed to take away your freedom to share  
and change it. By contrast, the GNU General Public Licenses are intended to

guarantee your freedom to share and change free software--to make sure the software is free for all its users.

This license, the Lesser General Public License, applies to some specially designated software packages--typically libraries--of the Free Software Foundation and other authors who decide to use it. You can use it too, but we suggest you first think carefully about whether this license or the ordinary General Public License is the better strategy to use in any particular case, based on the explanations below.

When we speak of free software, we are referring to freedom of use, not price. Our General Public Licenses are designed to make sure that you have the freedom to distribute copies of free software (and charge for this service if you wish); that you receive source code or can get it if you want it; that you can change the software and use pieces of it in new free programs; and that you are informed that you can do these things.

To protect your rights, we need to make restrictions that forbid distributors to deny you these rights or to ask you to surrender these rights. These restrictions translate to certain responsibilities for you if you distribute copies of the library or if you modify it.

For example, if you distribute copies of the library, whether gratis or for a fee, you must give the recipients all the rights that we gave you. You must make sure that they, too, receive or can get the source code. If you link other code with the library, you must provide complete object files to the recipients, so that they can relink them with the library after making changes to the library and recompiling it. And you must show them these terms so they know their rights.

We protect your rights with a two-step method: (1) we copyright the library, and (2) we offer you this license, which gives you legal permission to copy, distribute and/or modify the library.

To protect each distributor, we want to make it very clear that there is no warranty for the free library. Also, if the library is modified by someone else and passed on, the recipients should know that what they have is not the original version, so that the original author's reputation will not be affected by problems that might be introduced by others.

Finally, software patents pose a constant threat to the existence of any free program. We wish to make sure that a company cannot effectively restrict the users of a free program by obtaining a restrictive license from a patent holder. Therefore, we insist that any patent license obtained for a version of the library must be consistent with the full freedom of use specified in this license.

Most GNU software, including some libraries, is covered by the ordinary GNU General Public License. This license, the GNU Lesser General Public License, applies to certain designated libraries, and is quite different from the ordinary General Public License. We use this license for certain libraries in order to permit

linking those libraries into non-free programs. When a program is linked with a library, whether statically or using a shared library, the combination of the two is legally speaking a combined work, a derivative of the original library. The ordinary General Public License therefore permits such linking only if the entire combination fits its criteria of freedom. The Lesser General Public License permits more lax criteria for linking other code with the library.

We call this license the "Lesser" General Public License because it does Less to protect the user's freedom than the ordinary General Public License. It also provides other free software developers Less of an advantage over competing non-free programs. These disadvantages are the reason we use the ordinary General Public License for many libraries. However, the Lesser license provides advantages in certain special circumstances.

For example, on rare occasions, there may be a special need to encourage the widest possible use of a certain library, so that it becomes a de-facto standard. To achieve this, non-free programs must be allowed to use the library. A more frequent case is that a free library does the same job as widely used non-free libraries. In this case, there is little to gain by limiting the free library to free software only, so we use the Lesser General Public License.

In other cases, permission to use a particular library in non-free programs enables a greater number of people to use a large body of free software. For example, permission to use the GNU C Library in non-free programs enables many more people to use the whole GNU operating system, as well as its variant, the GNU/Linux operating system.

Although the Lesser General Public License is Less protective of the users' freedom, it does ensure that the user of a program that is linked with the Library has the freedom and the wherewithal to run that program using a modified version of the Library.

The precise terms and conditions for copying, distribution and modification follow. Pay close attention to the difference between a "work based on the library" and a "work that uses the library". The former contains code derived from the library, whereas the latter must be combined with the library in order to run.

#### TERMS AND CONDITIONS FOR COPYING, DISTRIBUTION AND MODIFICATION

**0.** This License Agreement applies to any software library or other program which contains a notice placed by the copyright holder or other authorized party saying it may be distributed under the terms of this Lesser General Public License (also called "this License"). Each licensee is addressed as "you".

A "library" means a collection of software functions and/or data prepared so as to be conveniently linked with application programs (which use some of those functions and data) to form executables.

The "Library", below, refers to any such software library or work which has been distributed under these terms. A "work based on the Library" means either the Library or any derivative work under copyright law: that is to say, a work containing the Library or a portion of it, either verbatim or with modifications and/or translated straightforwardly into another language. (Hereinafter, translation is included without limitation in the term "modification".)

"Source code" for a work means the preferred form of the work for making modifications to it. For a library, complete source code means all the source code for all modules it contains, plus any associated interface definition files, plus the scripts used to control compilation and installation of the library.

Activities other than copying, distribution and modification are not covered by this License; they are outside its scope. The act of running a program using the Library is not restricted, and output from such a program is covered only if its contents constitute a work based on the Library (independent of the use of the Library in a tool for writing it). Whether that is true depends on what the Library does and what the program that uses the Library does.

**1.** You may copy and distribute verbatim copies of the Library's complete source code as you receive it, in any medium, provided that you conspicuously and appropriately publish on each copy an appropriate copyright notice and disclaimer of warranty; keep intact all the notices that refer to this License and to the absence of any warranty; and distribute a copy of this License along with the Library.

You may charge a fee for the physical act of transferring a copy, and you may at your option offer warranty protection in exchange for a fee.

**2.** You may modify your copy or copies of the Library or any portion of it, thus forming a work based on the Library, and copy and distribute such modifications or work under the terms of Section 1 above, provided that you also meet all of these conditions:

**a)** The modified work must itself be a software library.

**b)** You must cause the files modified to carry prominent notices stating that you changed the files and the date of any change.

**c)** You must cause the whole of the work to be licensed at no charge to all third parties under the terms of this License.

**d)** If a facility in the modified Library refers to a function or a table of data to be supplied by an application program that uses the facility, other than as an argument passed when the facility is invoked, then you must make a good faith effort to ensure that, in the event an application does not supply such function or table, the facility still operates, and performs whatever part of its purpose remains meaningful.



(For example, a function in a library to compute square roots has a purpose that is entirely well-defined independent of the application. Therefore, Subsection 2d requires that any application-supplied function or table used by this function must be optional: if the application does not supply it, the square root function must still compute square roots.)

These requirements apply to the modified work as a whole. If identifiable sections of that work are not derived from the Library, and can be reasonably considered independent and separate works in themselves, then this License, and its terms, do not apply to those sections when you distribute them as separate works. But when you distribute the same sections as part of a whole which is a work based on the Library, the distribution of the whole must be on the terms of this License, whose permissions for other licensees extend to the entire whole, and thus to each and every part regardless of who wrote it.

Thus, it is not the intent of this section to claim rights or contest your rights to work written entirely by you; rather, the intent is to exercise the right to control the distribution of derivative or collective works based on the Library.

In addition, mere aggregation of another work not based on the Library with the Library (or with a work based on the Library) on a volume of a storage or distribution medium does not bring the other work under the scope of this License.

**3.** You may opt to apply the terms of the ordinary GNU General Public License instead of this License to a given copy of the Library. To do this, you must alter all the notices that refer to this License, so that they refer to the ordinary GNU General Public License, version 2, instead of to this License. (If a newer version than version 2 of the ordinary GNU General Public License has appeared, then you can specify that version instead if you wish.) Do not make any other change in these notices.

Once this change is made in a given copy, it is irreversible for that copy, so the ordinary GNU General Public License applies to all subsequent copies and derivative works made from that copy.

This option is useful when you wish to copy part of the code of the Library into a program that is not a library.

**4.** You may copy and distribute the Library (or a portion or derivative of it, under Section 2) in object code or executable form under the terms of Sections 1 and 2 above provided that you accompany it with the complete corresponding machine-readable source code, which must be distributed under the terms of Sections 1 and 2 above on a medium customarily used for software interchange.

If distribution of object code is made by offering access to copy from a designated place, then offering equivalent access to copy the source code from the same

place satisfies the requirement to distribute the source code, even though third parties are not compelled to copy the source along with the object code.

**5.** A program that contains no derivative of any portion of the Library, but is designed to work with the Library by being compiled or linked with it, is called a "work that uses the Library". Such a work, in isolation, is not a derivative work of the Library, and therefore falls outside the scope of this License.

However, linking a "work that uses the Library" with the Library creates an executable that is a derivative of the Library (because it contains portions of the Library), rather than a "work that uses the library". The executable is therefore covered by this License. Section 6 states terms for distribution of such executables.

When a "work that uses the Library" uses material from a header file that is part of the Library, the object code for the work may be a derivative work of the Library even though the source code is not. Whether this is true is especially significant if the work can be linked without the Library, or if the work is itself a library. The threshold for this to be true is not precisely defined by law.

If such an object file uses only numerical parameters, data structure layouts and accessors, and small macros and small inline functions (ten lines or less in length), then the use of the object file is unrestricted, regardless of whether it is legally a derivative work. (Executables containing this object code plus portions of the Library will still fall under Section 6.)

Otherwise, if the work is a derivative of the Library, you may distribute the object code for the work under the terms of Section 6. Any executables containing that work also fall under Section 6, whether or not they are linked directly with the Library itself.

**6.** As an exception to the Sections above, you may also combine or link a "work that uses the Library" with the Library to produce a work containing portions of the Library, and distribute that work under terms of your choice, provided that the terms permit modification of the work for the customer's own use and reverse engineering for debugging such modifications.

You must give prominent notice with each copy of the work that the Library is used in it and that the Library and its use are covered by this License. You must supply a copy of this License. If the work during execution displays copyright notices, you must include the copyright notice for the Library among them, as well as a reference directing the user to the copy of this License. Also, you must do one of these things:

**a)** Accompany the work with the complete corresponding machine-readable source code for the Library including whatever changes were used in the work (which must be distributed under Sections 1 and 2 above); and, if the work is an executable linked with the Library, with the complete machine-readable "work that uses the Library", as object code and/or source code, so that the user can

modify the Library and then relink to produce a modified executable containing the modified Library. (It is understood that the user who changes the contents of definitions files in the Library will not necessarily be able to recompile the application to use the modified definitions.)

**b)** Use a suitable shared library mechanism for linking with the Library. A suitable mechanism is one that (1) uses at run time a copy of the library already present on the user's computer system, rather than copying library functions into the executable, and (2) will operate properly with a modified version of the library, if the user installs one, as long as the modified version is interface-compatible with the version that the work was made with.

**c)** Accompany the work with a written offer, valid for at least three years, to give the same user the materials specified in Subsection 6a, above, for a charge no more than the cost of performing this distribution.

**d)** If distribution of the work is made by offering access to copy from a designated place, offer equivalent access to copy the above specified materials from the same place.

**e)** Verify that the user has already received a copy of these materials or that you have already sent this user a copy.

For an executable, the required form of the "work that uses the Library" must include any data and utility programs needed for reproducing the executable from it. However, as a special exception, the materials to be distributed need not include anything that is normally distributed (in either source or binary form) with the major components (compiler, kernel, and so on) of the operating system on which the executable runs, unless that component itself accompanies the executable.

It may happen that this requirement contradicts the license restrictions of other proprietary libraries that do not normally accompany the operating system. Such a contradiction means you cannot use both them and the Library together in an executable that you distribute.

**7.** You may place library facilities that are a work based on the Library side-by-side in a single library together with other library facilities not covered by this License, and distribute such a combined library, provided that the separate distribution of the work based on the Library and of the other library facilities is otherwise permitted, and provided that you do these two things:

**a)** Accompany the combined library with a copy of the same work based on the Library, uncombined with any other library facilities. This must be distributed under the terms of the Sections above.

**b)** Give prominent notice with the combined library of the fact that part of it is a work based on the Library, and explaining where to find the accompanying uncombined form of the same work.

**8.** You may not copy, modify, sublicense, link with, or distribute the Library except as expressly provided under this License. Any attempt otherwise to copy, modify, sublicense, link with, or distribute the Library is void, and will automatically terminate your rights under this License. However, parties who have received copies, or rights, from you under this License will not have their licenses terminated so long as such parties remain in full compliance.

**9.** You are not required to accept this License, since you have not signed it. However, nothing else grants you permission to modify or distribute the Library or its derivative works. These actions are prohibited by law if you do not accept this License. Therefore, by modifying or distributing the Library (or any work based on the Library), you indicate your acceptance of this License to do so, and all its terms and conditions for copying, distributing or modifying the Library or works based on it.

**10.** Each time you redistribute the Library (or any work based on the Library), the recipient automatically receives a license from the original licensor to copy, distribute, link with or modify the Library subject to these terms and conditions. You may not impose any further restrictions on the recipients' exercise of the rights granted herein. You are not responsible for enforcing compliance by third parties with this License.

**11.** If, as a consequence of a court judgment or allegation of patent infringement or for any other reason (not limited to patent issues), conditions are imposed on you (whether by court order, agreement or otherwise) that contradict the conditions of this License, they do not excuse you from the conditions of this License. If you cannot distribute so as to satisfy simultaneously your obligations under this License and any other pertinent obligations, then as a consequence you may not distribute the Library at all. For example, if a patent license would not permit royalty-free redistribution of the Library by all those who receive copies directly or indirectly through you, then the only way you could satisfy both it and this License would be to refrain entirely from distribution of the Library.

If any portion of this section is held invalid or unenforceable under any particular circumstance, the balance of the section is intended to apply, and the section as a whole is intended to apply in other circumstances.

It is not the purpose of this section to induce you to infringe any patents or other property right claims or to contest validity of any such claims; this section has the sole purpose of protecting the integrity of the free software distribution system which is implemented by public license practices. Many people have made generous contributions to the wide range of software distributed through that system in reliance on consistent application of that system; it is up to the

author/donor to decide if he or she is willing to distribute software through any other system and a licensee cannot impose that choice.

This section is intended to make thoroughly clear what is believed to be a consequence of the rest of this License.

**12.** If the distribution and/or use of the Library is restricted in certain countries either by patents or by copyrighted interfaces, the original copyright holder who places the Library under this License may add an explicit geographical distribution limitation excluding those countries, so that distribution is permitted only in or among countries not thus excluded. In such case, this License incorporates the limitation as if written in the body of this License.

**13.** The Free Software Foundation may publish revised and/or new versions of the Lesser General Public License from time to time. Such new versions will be similar in spirit to the present version, but may differ in detail to address new problems or concerns.

Each version is given a distinguishing version number. If the Library specifies a version number of this License which applies to it and "any later version", you have the option of following the terms and conditions either of that version or of any later version published by the Free Software Foundation. If the Library does not specify a license version number, you may choose any version ever published by the Free Software Foundation.

**14.** If you wish to incorporate parts of the Library into other free programs whose distribution conditions are incompatible with these, write to the author to ask for permission. For software which is copyrighted by the Free Software Foundation, write to the Free Software Foundation; we sometimes make exceptions for this. Our decision will be guided by the two goals of preserving the free status of all derivatives of our free software and of promoting the sharing and reuse of software generally.

#### NO WARRANTY

**15.** BECAUSE THE LIBRARY IS LICENSED FREE OF CHARGE, THERE IS NO WARRANTY FOR THE LIBRARY, TO THE EXTENT PERMITTED BY APPLICABLE LAW. EXCEPT WHEN OTHERWISE STATED IN WRITING THE COPYRIGHT HOLDERS AND/OR OTHER PARTIES PROVIDE THE LIBRARY "AS IS" WITHOUT WARRANTY OF ANY KIND, EITHER EXPRESSED OR IMPLIED, INCLUDING, BUT NOT LIMITED TO, THE IMPLIED WARRANTIES OF MERCHANTABILITY AND FITNESS FOR A PARTICULAR PURPOSE. THE ENTIRE RISK AS TO THE QUALITY AND PERFORMANCE OF THE LIBRARY IS WITH YOU. SHOULD THE LIBRARY PROVE DEFECTIVE, YOU ASSUME THE COST OF ALL NECESSARY SERVICING, REPAIR OR CORRECTION.

**16.** IN NO EVENT UNLESS REQUIRED BY APPLICABLE LAW OR AGREED TO IN WRITING WILL ANY COPYRIGHT HOLDER, OR ANY OTHER PARTY WHO MAY MODIFY AND/OR REDISTRIBUTE THE LIBRARY AS PERMITTED ABOVE, BE LIABLE TO YOU FOR DAMAGES, INCLUDING ANY GENERAL, SPECIAL, INCIDENTAL OR

CONSEQUENTIAL DAMAGES ARISING OUT OF THE USE OR INABILITY TO USE THE LIBRARY (INCLUDING BUT NOT LIMITED TO LOSS OF DATA OR DATA BEING RENDERED INACCURATE OR LOSSES SUSTAINED BY YOU OR THIRD PARTIES OR A FAILURE OF THE LIBRARY TO OPERATE WITH ANY OTHER SOFTWARE), EVEN IF SUCH HOLDER OR OTHER PARTY HAS BEEN ADVISED OF THE POSSIBILITY OF SUCH DAMAGES.

#### END OF TERMS AND CONDITIONS

##### How to Apply These Terms to Your New Libraries

If you develop a new library, and you want it to be of the greatest possible use to the public, we recommend making it free software that everyone can redistribute and change. You can do so by permitting redistribution under these terms (or, alternatively, under the terms of the ordinary General Public License).

To apply these terms, attach the following notices to the library. It is safest to attach them to the start of each source file to most effectively convey the exclusion of warranty; and each file should have at least the "copyright" line and a pointer to where the full notice is found.

one line to give the library's name and an idea of what it does.

Copyright (C) year name of author

This library is free software; you can redistribute it and/or modify it under the terms of the GNU Lesser General Public License as published by the Free Software Foundation; either version 2.1 of the License, or (at your option) any later version.

This library is distributed in the hope that it will be useful, but WITHOUT ANY WARRANTY; without even the implied warranty of MERCHANTABILITY or FITNESS FOR A PARTICULAR PURPOSE. See the GNU Lesser General Public License for more details.

You should have received a copy of the GNU Lesser General Public License along with this library; if not, write to the Free Software Foundation, Inc., 51 Franklin Street, Fifth Floor, Boston, MA 02110-1301 USA

Also add information on how to contact you by electronic and paper mail.

You should also get your employer (if you work as a programmer) or your school, if any, to sign a "copyright disclaimer" for the library, if necessary. Here is a sample; alter the names:

Yoyodyne, Inc., hereby disclaims all copyright interest in  
the library `Frob' (a library for tweaking knobs) written  
by James Random Hacker.

signature of Ty Coon, 1 April 1990

Ty Coon, President of Vice

That's all there is to it!

```
# (C) Copyright 2002-2006
# Wolfgang Denk, DENX Software Engineering, wd@denx.de.
#
# See file CREDITS for list of people who contributed to this
# project.
#
# This program is free software; you can redistribute it and/or
# modify it under the terms of the GNU General Public License as
# published by the Free Software Foundation; either version 2 of
# the License, or (at your option) any later version.
#
# This program is distributed in the hope that it will be useful,
# but WITHOUT ANY WARRANTY; without even the implied warranty of
# MERCHANTABILITY or FITNESS FOR A PARTICULAR PURPOSE. See the
# GNU General Public License for more details.
#
# You should have received a copy of the GNU General Public License
# along with this program; if not, write to the Free Software
# Foundation, Inc., 59 Temple Place, Suite 330, Boston,
# MA 02111-1307 USA
#
```

*libpcap*

Copyright (c) 1999 - 2005 NetGroup, Politecnico di Torino (Italy)  
Copyright (c) 2005 - 2008 CACE Technologies, Davis (California)  
Copyright (c) 1997 Yen Yen Lim and North Dakota State University  
Copyright (c) 1995-1999 Kungliga Tekniska Högskolan  
Copyright (c) 1982, 1986, 1988 - 1998, 2000 The Regents of the University of California  
Copyright (c) 2000 Torsten Landschoff <torsten@debian.org>, Sebastian Krahmer <krahmer@cs.uni-potsdam.de>  
Copyright (c) 2006 Paolo Abeni (Italy)  
Copyright (c) 2007 Fulko Hew, SITA INC Canada, Inc <fulko.hew@sita.aero>  
Copyright (c) 2001 Atsushi Onoe  
Copyright (c) 2002-2005 Sam Leffler, Errno Consulting  
Copyright 1989 by Carnegie Mellon  
Copyright (c) 1996 Juniper Networks, Inc.  
Copyright (c) 1993,1994 Texas A&M University.  
Copyright (C) 1995, 1996, 1997, and 1998 WIDE Project.  
Portions Copyright (c) 1993 by Digital Equipment Corporation.  
Copyright (C) 1999 WIDE Project.  
Copyright (c) 2005 - 2006 CACE Technologies, Davis (California)

(Ref: libpcap-1.0.0/LICENSE)

License: BSD

Redistribution and use in source and binary forms, with or without modification, are permitted provided that the following conditions are met:

1. Redistributions of source code must retain the above copyright notice, this list of conditions and the following disclaimer.
2. Redistributions in binary form must reproduce the above copyright notice, this list of conditions and the following disclaimer in the documentation and/or other materials provided with the distribution.
3. The names of the authors may not be used to endorse or promote products derived from this software without specific prior written permission.

THIS SOFTWARE IS PROVIDED ``AS IS'' AND WITHOUT ANY EXPRESS OR IMPLIED WARRANTIES, INCLUDING, WITHOUT LIMITATION, THE IMPLIED WARRANTIES OF MERCHANTABILITY AND FITNESS FOR A PARTICULAR PURPOSE.

```
# (C) Copyright 2002-2006
# Wolfgang Denk, DENX Software Engineering, wd@denx.de.
#
# See file CREDITS for list of people who contributed to this
# project.
```



	<pre># # This program is free software; you can redistribute it and/or # modify it under the terms of the GNU General Public License as # published by the Free Software Foundation; either version 2 of # the License, or (at your option) any later version. # # This program is distributed in the hope that it will be useful, # but WITHOUT ANY WARRANTY; without even the implied warranty of # MERCHANTABILITY or FITNESS FOR A PARTICULAR PURPOSE. See the # GNU General Public License for more details. # # You should have received a copy of the GNU General Public License # along with this program; if not, write to the Free Software # Foundation, Inc., 59 Temple Place, Suite 330, Boston, # MA 02111-1307 USA #</pre>
<i>libtool</i>	<p>GNU GENERAL PUBLIC LICENSE Version 2, June 1991</p> <p>Copyright (C) 1989, 1991 Free Software Foundation, Inc., 51 Franklin Street, Fifth Floor, Boston, MA 02110-1301 USA Everyone is permitted to copy and distribute verbatim copies of this license document, but changing it is not allowed.</p> <p>See full license text on page <a href="#">335</a>.</p> <pre># (C) Copyright 2002-2006 # Wolfgang Denk, DENX Software Engineering, wd@denx.de. # # See file CREDITS for list of people who contributed to this # project. # # This program is free software; you can redistribute it and/or # modify it under the terms of the GNU General Public License as # published by the Free Software Foundation; either version 2 of # the License, or (at your option) any later version. # # This program is distributed in the hope that it will be useful, # but WITHOUT ANY WARRANTY; without even the implied warranty of # MERCHANTABILITY or FITNESS FOR A PARTICULAR PURPOSE. See the # GNU General Public License for more details. # # You should have received a copy of the GNU General Public License # along with this program; if not, write to the Free Software # Foundation, Inc., 59 Temple Place, Suite 330, Boston, # MA 02111-1307 USA #</pre>
<i>libjson-c</i>	<p>Copyright (c) 2009-2012 Eric Haszlakiewicz</p> <p>Permission is hereby granted, free of charge, to any person obtaining a copy of this software and associated documentation files (the "Software"), to deal in the</p>

Software without restriction, including without limitation the rights to use, copy, modify, merge, publish, distribute, sublicense, and/or sell copies of the Software, and to permit persons to whom the Software is furnished to do so, subject to the following conditions:

The above copyright notice and this permission notice shall be included in all copies or substantial portions of the Software.

THE SOFTWARE IS PROVIDED "AS IS", WITHOUT WARRANTY OF ANY KIND, EXPRESS OR IMPLIED, INCLUDING BUT NOT LIMITED TO THE WARRANTIES OF MERCHANTABILITY, FITNESS FOR A PARTICULAR PURPOSE AND NONINFRINGEMENT. IN NO EVENT SHALL THE AUTHORS OR COPYRIGHT HOLDERS BE LIABLE FOR ANY CLAIM, DAMAGES OR OTHER LIABILITY, WHETHER IN AN ACTION OF CONTRACT, TORT OR OTHERWISE, ARISING FROM, OUT OF OR IN CONNECTION WITH THE SOFTWARE OR THE USE OR OTHER DEALINGS IN THE SOFTWARE.

-----  
Copyright (c) 2004, 2005 Metaparadigm Pte Ltd

Permission is hereby granted, free of charge, to any person obtaining a copy of this software and associated documentation files (the "Software"), to deal in the Software without restriction, including without limitation the rights to use, copy, modify, merge, publish, distribute, sublicense, and/or sell copies of the Software, and to permit persons to whom the Software is furnished to do so, subject to the following conditions:

The above copyright notice and this permission notice shall be included in all copies or substantial portions of the Software.

THE SOFTWARE IS PROVIDED "AS IS", WITHOUT WARRANTY OF ANY KIND, EXPRESS OR IMPLIED, INCLUDING BUT NOT LIMITED TO THE WARRANTIES OF MERCHANTABILITY, FITNESS FOR A PARTICULAR PURPOSE AND NONINFRINGEMENT. IN NO EVENT SHALL THE AUTHORS OR COPYRIGHT HOLDERS BE LIABLE FOR ANY CLAIM, DAMAGES OR OTHER LIABILITY, WHETHER IN AN ACTION OF CONTRACT, TORT OR OTHERWISE, ARISING FROM, OUT OF OR IN CONNECTION WITH THE SOFTWARE OR THE USE OR OTHER DEALINGS IN THE SOFTWARE.

# (C) Copyright 2002-2006  
# Wolfgang Denk, DENX Software Engineering, wd@denx.de.  
#  
# See file CREDITS for list of people who contributed to this  
# project.  
#  
# This program is free software; you can redistribute it and/or  
# modify it under the terms of the GNU General Public License as  
# published by the Free Software Foundation; either version 2 of

```
# the License, or (at your option) any later version.
#
# This program is distributed in the hope that it will be useful,
# but WITHOUT ANY WARRANTY; without even the implied warranty of
# MERCHANTABILITY or FITNESS FOR A PARTICULAR PURPOSE. See the
# GNU General Public License for more details.
#
# You should have received a copy of the GNU General Public License
# along with this program; if not, write to the Free Software
# Foundation, Inc., 59 Temple Place, Suite 330, Boston,
# MA 02111-1307 USA
#
```

***LibWebSockets***

Libwebsockets and included programs are provided under the terms of the GNU Library General Public License (LGPL) 2.1, with the following exceptions:

1) Static linking of programs with the libwebsockets library does not constitute a derivative work and does not require the author to provide source code for the program, use the shared libwebsockets libraries, or link their program against a user-supplied version of libwebsockets.

If you link the program to a modified version of libwebsockets, then the changes to libwebsockets must be provided under the terms of the LGPL in sections 1, 2, and 4.

2) You do not have to provide a copy of the libwebsockets license with programs that are linked to the libwebsockets library, nor do you have to identify the libwebsockets license in your program or documentation as required by section 6 of the LGPL.

However, programs must still identify their use of libwebsockets. The following example statement can be included in user documentation to satisfy this requirement:

"[program] is based in part on the work of the libwebsockets project (<http://libwebsockets.org>)"

GNU LESSER GENERAL PUBLIC LICENSE  
Version 2.1, February 1999

Copyright (C) 1991, 1999 Free Software Foundation, Inc.  
51 Franklin Street, Fifth Floor, Boston, MA 02110-1301 USA  
Everyone is permitted to copy and distribute verbatim copies  
of this license document, but changing it is not allowed.

[This is the first released version of the Lesser GPL. It also counts as the successor of the GNU Library Public License, version 2, hence the version number 2.1.]

See full license text on page [357](#).

```
# (C) Copyright 2002-2006
# Wolfgang Denk, DENX Software Engineering, wd@denx.de.
#
# See file CREDITS for list of people who contributed to this
# project.
#
# This program is free software; you can redistribute it and/or
# modify it under the terms of the GNU General Public License as
# published by the Free Software Foundation; either version 2 of
# the License, or (at your option) any later version.
#
# This program is distributed in the hope that it will be useful,
# but WITHOUT ANY WARRANTY; without even the implied warranty of
# MERCHANTABILITY or FITNESS FOR A PARTICULAR PURPOSE. See the
# GNU General Public License for more details.
#
# You should have received a copy of the GNU General Public License
# along with this program; if not, write to the Free Software
# Foundation, Inc., 59 Temple Place, Suite 330, Boston,
# MA 02111-1307 USA
#
```

*Libjansson*

Copyright (c) 2009-2013 Petri Lehtinen <[petri@digip.org](mailto:petri@digip.org)>

Permission is hereby granted, free of charge, to any person obtaining a copy of this software and associated documentation files (the "Software"), to deal in the Software without restriction, including without limitation the rights to use, copy, modify, merge, publish, distribute, sublicense, and/or sell copies of the Software, and to permit persons to whom the Software is furnished to do so, subject to the following conditions:

The above copyright notice and this permission notice shall be included in all copies or substantial portions of the Software.

THE SOFTWARE IS PROVIDED "AS IS", WITHOUT WARRANTY OF ANY KIND, EXPRESS OR IMPLIED, INCLUDING BUT NOT LIMITED TO THE WARRANTIES OF MERCHANTABILITY, FITNESS FOR A PARTICULAR PURPOSE AND NONINFRINGEMENT. IN NO EVENT SHALL THE AUTHORS OR COPYRIGHT HOLDERS BE LIABLE FOR ANY CLAIM, DAMAGES OR OTHER LIABILITY, WHETHER IN AN ACTION OF CONTRACT, TORT OR OTHERWISE, ARISING FROM, OUT OF OR IN CONNECTION WITH THE SOFTWARE OR THE USE OR OTHER DEALINGS IN THE SOFTWARE.

```
# (C) Copyright 2002-2006
# Wolfgang Denk, DENX Software Engineering, wd@denx.de.
#
# See file CREDITS for list of people who contributed to this
# project.
```

```

#
# This program is free software; you can redistribute it and/or
# modify it under the terms of the GNU General Public License as
# published by the Free Software Foundation; either version 2 of
# the License, or (at your option) any later version.
#
# This program is distributed in the hope that it will be useful,
# but WITHOUT ANY WARRANTY; without even the implied warranty of
# MERCHANTABILITY or FITNESS FOR A PARTICULAR PURPOSE. See the
# GNU General Public License for more details.
#
# You should have received a copy of the GNU General Public License
# along with this program; if not, write to the Free Software
# Foundation, Inc., 59 Temple Place, Suite 330, Boston,
# MA 02111-1307 USA
#

```

*lua*

Lua License

-----

Lua is licensed under the terms of the MIT license reproduced below. This means that Lua is free software and can be used for both academic and commercial purposes at absolutely no cost.

For details and rationale, see <http://www.lua.org/license.html> .

=====  
=====

Copyright (C) 1994-2008 Lua.org, PUC-Rio.

Permission is hereby granted, free of charge, to any person obtaining a copy of this software and associated documentation files (the "Software"), to deal in the Software without restriction, including without limitation the rights to use, copy, modify, merge, publish, distribute, sublicense, and/or sell copies of the Software, and to permit persons to whom the Software is furnished to do so, subject to the following conditions:

The above copyright notice and this permission notice shall be included in all copies or substantial portions of the Software.

THE SOFTWARE IS PROVIDED "AS IS", WITHOUT WARRANTY OF ANY KIND, EXPRESS OR IMPLIED, INCLUDING BUT NOT LIMITED TO THE WARRANTIES OF MERCHANTABILITY, FITNESS FOR A PARTICULAR PURPOSE AND NONINFRINGEMENT. IN NO EVENT SHALL THE AUTHORS OR COPYRIGHT HOLDERS BE LIABLE FOR ANY CLAIM, DAMAGES OR OTHER LIABILITY, WHETHER IN AN ACTION OF CONTRACT, TORT OR OTHERWISE,

ARISING FROM, OUT OF OR IN CONNECTION WITH THE SOFTWARE OR THE USE OR OTHER DEALINGS IN THE SOFTWARE.

```
# (C) Copyright 2002-2006
# Wolfgang Denk, DENX Software Engineering, wd@denx.de.
#
# See file CREDITS for list of people who contributed to this
# project.
#
# This program is free software; you can redistribute it and/or
# modify it under the terms of the GNU General Public License as
# published by the Free Software Foundation; either version 2 of
# the License, or (at your option) any later version.
#
# This program is distributed in the hope that it will be useful,
# but WITHOUT ANY WARRANTY; without even the implied warranty of
# MERCHANTABILITY or FITNESS FOR A PARTICULAR PURPOSE. See the
# GNU General Public License for more details.
#
# You should have received a copy of the GNU General Public License
# along with this program; if not, write to the Free Software
# Foundation, Inc., 59 Temple Place, Suite 330, Boston,
# MA 02111-1307 USA
#
```

*LuCi*

Apache License

Version 2.0, January 2004

<http://www.apache.org/licenses/>

TERMS AND CONDITIONS FOR USE, REPRODUCTION, AND DISTRIBUTION

1. Definitions.

"License" shall mean the terms and conditions for use, reproduction, and distribution as defined by Sections 1 through 9 of this document.

"Licensor" shall mean the copyright owner or entity authorized by the copyright owner that is granting the License.

"Legal Entity" shall mean the union of the acting entity and all other entities that control, are controlled by, or are under common control with that entity. For the purposes of this definition, "control" means (i) the power, direct or indirect, to cause the direction or management of such entity, whether by contract or otherwise, or (ii) ownership of fifty percent (50%) or more of the outstanding shares, or (iii) beneficial ownership of such entity.

"You" (or "Your") shall mean an individual or Legal Entity exercising permissions granted by this License.

"Source" form shall mean the preferred form for making modifications, including but not limited to software source code, documentation source, and configuration files.

"Object" form shall mean any form resulting from mechanical transformation or translation of a Source form, including but not limited to compiled object code, generated documentation, and conversions to other media types.

"Work" shall mean the work of authorship, whether in Source or Object form, made available under the License, as indicated by a copyright notice that is included in or attached to the work (an example is provided in the Appendix below).

"Derivative Works" shall mean any work, whether in Source or Object form, that is based on (or derived from) the Work and for which the editorial revisions, annotations, elaborations, or other modifications represent, as a whole, an original work of authorship. For the purposes of this License, Derivative Works shall not include works that remain separable from, or merely link (or bind by name) to the interfaces of, the Work and Derivative Works thereof.

"Contribution" shall mean any work of authorship, including the original version of the Work and any modifications or additions to that Work or Derivative Works thereof, that is intentionally submitted to Licensor for inclusion in the Work by the copyright owner or by an individual or Legal Entity authorized to submit on behalf of the copyright owner. For the purposes of this definition, "submitted" means any form of electronic, verbal, or written communication sent to the Licensor or its representatives, including but not limited to communication on electronic mailing lists, source code control systems, and issue tracking systems that are managed by, or on behalf of, the Licensor for the purpose of discussing and improving the Work, but excluding communication that is conspicuously marked or otherwise designated in writing by the copyright owner as "Not a Contribution."

"Contributor" shall mean Licensor and any individual or Legal Entity on behalf of whom a Contribution has been received by Licensor and subsequently incorporated within the Work.

2. Grant of Copyright License. Subject to the terms and conditions of this License, each Contributor hereby grants to You a perpetual, worldwide, non-exclusive, no-charge, royalty-free, irrevocable copyright license to reproduce, prepare Derivative Works of, publicly display, publicly perform, sublicense, and distribute the Work and such Derivative Works in Source or Object form.

3. Grant of Patent License. Subject to the terms and conditions of this License, each Contributor hereby grants to You a perpetual, worldwide, non-exclusive, no-charge, royalty-free, irrevocable (except as stated in this section) patent license to make, have made, use, offer to sell, sell, import, and otherwise transfer the Work, where such license applies only to those patent claims licensable by such Contributor that are necessarily infringed by their Contribution(s) alone or by combination of their Contribution(s) with the Work to which such Contribution(s) was submitted. If You institute patent litigation against any entity (including a cross-claim or counterclaim in a lawsuit) alleging that the Work or a Contribution incorporated within the Work constitutes direct or contributory patent infringement, then any patent licenses granted to You under this License for that Work shall terminate as of the date such litigation is filed.

4. Redistribution. You may reproduce and distribute copies of the Work or Derivative Works thereof in any medium, with or without modifications, and in Source or Object form, provided that You meet the following conditions:

You must give any other recipients of the Work or Derivative Works a copy of this License; and

You must cause any modified files to carry prominent notices stating that You changed the files; and

You must retain, in the Source form of any Derivative Works that You distribute, all copyright, patent, trademark, and attribution notices from the Source form of the Work, excluding those notices that do not pertain to any part of the Derivative Works; and If the Work includes a "NOTICE" text file as part of its distribution, then any Derivative Works that You distribute must include a readable copy of the attribution notices contained within such NOTICE file, excluding those notices that do not pertain to any part of the Derivative Works, in at least one of the following places: within a NOTICE text file distributed as part of the Derivative Works; within the Source form or documentation, if provided along with the Derivative Works; or, within a display generated by the Derivative Works, if and wherever such third-party notices normally appear. The contents of the NOTICE file are for informational purposes only and do not modify the License. You may add Your own attribution notices within Derivative Works that You distribute, alongside or as an addendum to the NOTICE text from the Work, provided that such additional attribution notices cannot be construed as modifying the License.

You may add Your own copyright statement to Your modifications and may provide additional or different license terms and conditions for use, reproduction, or distribution of Your modifications, or for any such Derivative Works as a whole, provided Your use, reproduction, and distribution of the Work otherwise complies with the conditions stated in this License.

5. Submission of Contributions. Unless You explicitly state otherwise, any Contribution intentionally submitted for inclusion in the Work by You to the Licensor shall be under the terms and conditions of this License, without any additional terms or conditions. Notwithstanding the above, nothing herein shall supersede or modify the terms of any separate license agreement you may have executed with Licensor regarding such Contributions.

6. Trademarks. This License does not grant permission to use the trade names, trademarks, service marks, or product names of the Licensor, except as required for reasonable and customary use in describing the origin of the Work and reproducing the content of the NOTICE file.

7. Disclaimer of Warranty. Unless required by applicable law or agreed to in writing, Licensor provides the Work (and each Contributor provides its Contributions) on an "AS IS" BASIS, WITHOUT WARRANTIES OR CONDITIONS OF ANY KIND, either express or implied, including, without limitation, any warranties or conditions of TITLE, NON-INFRINGEMENT, MERCHANTABILITY, or FITNESS FOR A PARTICULAR PURPOSE. You are solely responsible for determining the appropriateness of using or redistributing the Work and assume any risks associated with Your exercise of permissions under this License.

8. Limitation of Liability. In no event and under no legal theory, whether in tort (including negligence), contract, or otherwise, unless required by applicable law (such as deliberate and grossly negligent acts) or agreed to in writing, shall any Contributor be liable to You for damages, including any direct, indirect, special, incidental, or consequential damages of any character arising as a result of this License or out of the use or inability to use the Work (including but not limited to damages for loss of goodwill, work stoppage, computer failure or malfunction, or any and all other commercial damages or losses), even if such Contributor has been advised of the possibility of such damages.



9. Accepting Warranty or Additional Liability. While redistributing the Work or Derivative Works thereof, You may choose to offer, and charge a fee for, acceptance of support, warranty, indemnity, or other liability obligations and/or rights consistent with this License. However, in accepting such obligations, You may act only on Your own behalf and on Your sole responsibility, not on behalf of any other Contributor, and only if You agree to indemnify, defend, and hold each Contributor harmless for any liability incurred by, or claims asserted against, such Contributor by reason of your accepting any such warranty or additional liability.

END OF TERMS AND CONDITIONS

```
--[[
LuCI - Lua Development Framework
Copyright 2009 Steven Barth <steven@midlink.org>
Licensed under the Apache License, Version 2.0 (the "License");
you may not use this file except in compliance with the License.
You may obtain a copy of the License at
http://www.apache.org/licenses/LICENSE-2.0
$id$
]]
```

*mtd*

```
Copyright © 2005 Waldemar Brodkorb <wbx@dass-it.de>
Copyright (C) 2005-2009 Felix Fietkau <ndb@openwrt.org>

#
# Copyright (C) 2006-2009 OpenWrt.org
#
# This is free software, licensed under the GNU General Public License v2.
#

See full license text on page 335.

# (C) Copyright 2002-2006
# Wolfgang Denk, DENX Software Engineering, wd@denx.de.
#
# See file CREDITS for list of people who contributed to this
# project.
#
# This program is free software; you can redistribute it and/or
# modify it under the terms of the GNU General Public License as
# published by the Free Software Foundation; either version 2 of
# the License, or (at your option) any later version.
#
# This program is distributed in the hope that it will be useful,
# but WITHOUT ANY WARRANTY; without even the implied warranty of
# MERCHANTABILITY or FITNESS FOR A PARTICULAR PURPOSE. See the
# GNU General Public License for more details.
#
# You should have received a copy of the GNU General Public License
# along with this program; if not, write to the Free Software
# Foundation, Inc., 59 Temple Place, Suite 330, Boston,
# MA 02111-1307 USA
#
```

*ncurses*

Copyright (c) 1998-2004,2006 Free Software Foundation, Inc.

Permission is hereby granted, free of charge, to any person obtaining a copy of this software and associated documentation files (the "Software"), to deal in the Software without restriction, including without limitation the rights to use, copy, modify, merge, publish, distribute, distribute with modifications, sublicense, and/or sell copies of the Software, and to permit persons to whom the Software is furnished to do so, subject to the following conditions:

The above copyright notice and this permission notice shall be included in all copies or substantial portions of the Software.

THE SOFTWARE IS PROVIDED "AS IS", WITHOUT WARRANTY OF ANY KIND, EXPRESS OR IMPLIED, INCLUDING BUT NOT LIMITED TO THE WARRANTIES OF MERCHANTABILITY, FITNESS FOR A PARTICULAR PURPOSE AND NONINFRINGEMENT. IN NO EVENT SHALL THE ABOVE COPYRIGHT HOLDERS BE LIABLE FOR ANY CLAIM, DAMAGES OR OTHER LIABILITY, WHETHER IN AN ACTION OF CONTRACT, TORT OR OTHERWISE, ARISING FROM, OUT OF OR IN CONNECTION WITH THE SOFTWARE OR THE USE OR OTHER DEALINGS IN THE SOFTWARE.

Except as contained in this notice, the name(s) of the above copyright holders shall not be used in advertising or otherwise to promote the sale, use or other dealings in this Software without prior written authorization.

```
# (C) Copyright 2002-2006
# Wolfgang Denk, DENX Software Engineering, wd@denx.de.
#
# See file CREDITS for list of people who contributed to this
# project.
#
# This program is free software; you can redistribute it and/or
# modify it under the terms of the GNU General Public License as
# published by the Free Software Foundation; either version 2 of
# the License, or (at your option) any later version.
#
# This program is distributed in the hope that it will be useful,
# but WITHOUT ANY WARRANTY; without even the implied warranty of
# MERCHANTABILITY or FITNESS FOR A PARTICULAR PURPOSE. See the
# GNU General Public License for more details.
#
# You should have received a copy of the GNU General Public License
# along with this program; if not, write to the Free Software
# Foundation, Inc., 59 Temple Place, Suite 330, Boston,
# MA 02111-1307 USA
#
```

*nginx*

Copyright (C) 2002-2012 Igor Sysoev  
Copyright (C) 2011,2012 Nginx, Inc.

Redistribution and use in source and binary forms, with or without modification, are permitted provided that the following conditions

are met:

1. Redistributions of source code must retain the above copyright notice, this list of conditions and the following disclaimer.
2. Redistributions in binary form must reproduce the above copyright notice, this list of conditions and the following disclaimer in the documentation and/or other materials provided with the distribution.

THIS SOFTWARE IS PROVIDED BY AUTHOR AND CONTRIBUTORS ``AS IS" AND ANY EXPRESS OR IMPLIED WARRANTIES, INCLUDING, BUT NOT LIMITED TO, THE IMPLIED WARRANTIES OF MERCHANTABILITY AND FITNESS FOR A PARTICULAR PURPOSE ARE DISCLAIMED. IN NO EVENT SHALL AUTHOR OR CONTRIBUTORS BE LIABLE FOR ANY DIRECT, INDIRECT, INCIDENTAL, SPECIAL, EXEMPLARY, OR CONSEQUENTIAL DAMAGES (INCLUDING, BUT NOT LIMITED TO, PROCUREMENT OF SUBSTITUTE GOODS OR SERVICES; LOSS OF USE, DATA, OR PROFITS; OR BUSINESS INTERRUPTION) HOWEVER CAUSED AND ON ANY THEORY OF LIABILITY, WHETHER IN CONTRACT, STRICT LIABILITY, OR TORT (INCLUDING NEGLIGENCE OR OTHERWISE) ARISING IN ANY WAY OUT OF THE USE OF THIS SOFTWARE, EVEN IF ADVISED OF THE POSSIBILITY OF SUCH DAMAGE.

# (C) Copyright 2002-2006

# Wolfgang Denk, DENX Software Engineering, wd@denx.de.

#

# See file CREDITS for list of people who contributed to this  
# project.

#

# This program is free software; you can redistribute it and/or  
# modify it under the terms of the GNU General Public License as  
# published by the Free Software Foundation; either version 2 of  
# the License, or (at your option) any later version.

#

# This program is distributed in the hope that it will be useful,  
# but WITHOUT ANY WARRANTY; without even the implied warranty of  
# MERCHANTABILITY or FITNESS FOR A PARTICULAR PURPOSE. See the  
# GNU General Public License for more details.

#

# You should have received a copy of the GNU General Public License  
# along with this program; if not, write to the Free Software  
# Foundation, Inc., 59 Temple Place, Suite 330, Boston,  
# MA 02111-1307 USA

#

*Net-snmp*

Copyright 1989, 1991, 1992 by Carnegie Mellon University  
Derivative Work - 1996, 1998-2000

Copyright 1996, 1998-2000 The Regents of the University of California  
Networks Associates Technology, Inc copyright notice (BSD)

Copyright (c) 2001-2003, Networks Associates Technology, Inc

Cambridge Broadband Ltd. copyright notice (BSD)  
Portions of this code are copyright (c) 2001-2003, Cambridge Broadband Ltd.  
Copyright © 2003 Sun Microsystems, Inc., 4150 Network Circle, Santa Clara,  
California 95054, U.S.A.  
Copyright (c) 2003-2008, Sparta, Inc  
Copyright (c) 2004, Cisco, Inc and Information Network  
Center of Beijing University of Posts and Telecommunications.  
Fabasoft R&D Software GmbH & Co KG copyright notice (BSD)  
Copyright (c) Fabasoft R&D Software GmbH & Co KG, 2003 oss@fabasoft.com  
Author: Bernhard Penz [bernhard.penz@fabasoft.com](mailto:bernhard.penz@fabasoft.com)

```
# (C) Copyright 2002-2006
# Wolfgang Denk, DENX Software Engineering, wd@denx.de.
#
# See file CREDITS for list of people who contributed to this
# project.
#
# This program is free software; you can redistribute it and/or
# modify it under the terms of the GNU General Public License as
# published by the Free Software Foundation; either version 2 of
# the License, or (at your option) any later version.
#
# This program is distributed in the hope that it will be useful,
# but WITHOUT ANY WARRANTY; without even the implied warranty of
# MERCHANTABILITY or FITNESS FOR A PARTICULAR PURPOSE. See the
# GNU General Public License for more details.
#
# You should have received a copy of the GNU General Public License
# along with this program; if not, write to the Free Software
# Foundation, Inc., 59 Temple Place, Suite 330, Boston,
# MA 02111-1307 USA
#
```

BSD like:

Permission to use, copy, modify and distribute this software and its documentation for any purpose and without fee is hereby granted, provided that the above copyright notice appears in all copies and that both that copyright notice and this permission notice appear in supporting documentation, and that the name of CMU and The Regents of the University of California not be used in advertising or publicity pertaining to distribution of the software without specific written permission.

CMU AND THE REGENTS OF THE UNIVERSITY OF CALIFORNIA DISCLAIM ALL WARRANTIES WITH REGARD TO THIS SOFTWARE, INCLUDING ALL IMPLIED WARRANTIES OF MERCHANTABILITY AND FITNESS. IN NO EVENT SHALL CMU OR THE REGENTS OF THE UNIVERSITY OF CALIFORNIA BE LIABLE FOR ANY SPECIAL, INDIRECT OR CONSEQUENTIAL DAMAGES OR ANY DAMAGES WHATSOEVER

RESULTING FROM THE LOSS OF USE, DATA OR PROFITS, WHETHER IN AN ACTION OF CONTRACT, NEGLIGENCE OR OTHER TORTIOUS ACTION, ARISING OUT OF OR IN CONNECTION WITH THE USE OR PERFORMANCE OF THIS SOFTWARE.

BSD:

Redistribution and use in source and binary forms, with or without modification, are permitted provided that the following conditions are met:

- \* Redistributions of source code must retain the above copyright notice, this list of conditions and the following disclaimer.
- \* Redistributions in binary form must reproduce the above copyright notice, this list of conditions and the following disclaimer in the documentation and/or other materials provided with the distribution.
- \* Neither the name of the Networks Associates Technology, Inc nor the names of its contributors may be used to endorse or promote products derived from this software without specific prior written permission.

THIS SOFTWARE IS PROVIDED BY THE COPYRIGHT HOLDERS AND CONTRIBUTORS ``AS IS'' AND ANY EXPRESS OR IMPLIED WARRANTIES, INCLUDING, BUT NOT LIMITED TO, THE IMPLIED WARRANTIES OF MERCHANTABILITY AND FITNESS FOR A PARTICULAR PURPOSE ARE DISCLAIMED. IN NO EVENT SHALL THE COPYRIGHT HOLDERS OR CONTRIBUTORS BE LIABLE FOR ANY DIRECT, INDIRECT, INCIDENTAL, SPECIAL, EXEMPLARY, OR CONSEQUENTIAL DAMAGES (INCLUDING, BUT NOT LIMITED TO, PROCUREMENT OF SUBSTITUTE GOODS OR SERVICES; LOSS OF USE, DATA, OR PROFITS; OR BUSINESS INTERRUPTION) HOWEVER CAUSED AND ON ANY THEORY OF LIABILITY, WHETHER IN CONTRACT, STRICT LIABILITY, OR TORT (INCLUDING NEGLIGENCE OR OTHERWISE) ARISING IN ANY WAY OUT OF THE USE OF THIS SOFTWARE, EVEN IF ADVISED OF THE POSSIBILITY OF SUCH DAMAGE.

# (C) Copyright 2002-2006

# Wolfgang Denk, DENX Software Engineering, wd@denx.de.

#

# See file CREDITS for list of people who contributed to this

# project.

#

# This program is free software; you can redistribute it and/or  
# modify it under the terms of the GNU General Public License as  
# published by the Free Software Foundation; either version 2 of  
# the License, or (at your option) any later version.

#

# This program is distributed in the hope that it will be useful,  
# but WITHOUT ANY WARRANTY; without even the implied warranty of  
# MERCHANTABILITY or FITNESS FOR A PARTICULAR PURPOSE. See the  
# GNU General Public License for more details.

#

# You should have received a copy of the GNU General Public License  
# along with this program; if not, write to the Free Software

	<pre># Foundation, Inc., 59 Temple Place, Suite 330, Boston, # MA 02111-1307 USA #</pre>
<i>openssh</i>	<pre># # Copyright (C) 2006, 2008-2011 OpenWrt.org # # This is free software, licensed under the GNU General Public License v2. # # # See full license text on page 335. # # (C) Copyright 2002-2006 # Wolfgang Denk, DENX Software Engineering, wd@denx.de. # # See file CREDITS for list of people who contributed to this # project. # # This program is free software; you can redistribute it and/or # modify it under the terms of the GNU General Public License as # published by the Free Software Foundation; either version 2 of # the License, or (at your option) any later version. # # This program is distributed in the hope that it will be useful, # but WITHOUT ANY WARRANTY; without even the implied warranty of # MERCHANTABILITY or FITNESS FOR A PARTICULAR PURPOSE. See the # GNU General Public License for more details. # # You should have received a copy of the GNU General Public License # along with this program; if not, write to the Free Software # Foundation, Inc., 59 Temple Place, Suite 330, Boston, # MA 02111-1307 USA #</pre>
<i>openssl</i>	<pre>LICENSE ISSUES =====  The OpenSSL toolkit stays under a dual license, i.e. both the conditions of the OpenSSL License and the original SSLeay license apply to the toolkit. See below for the actual license texts. Actually both licenses are BSD-style Open Source licenses. In case of any license issues related to OpenSSL please contact openssl- core@openssl.org.  OpenSSL License -----  /* ===== =</pre>

\* Copyright (c) 1998-2011 The OpenSSL Project. All rights reserved.  
\*  
\* Redistribution and use in source and binary forms, with or without  
\* modification, are permitted provided that the following conditions  
\* are met:  
\*  
\* 1. Redistributions of source code must retain the above copyright  
\* notice, this list of conditions and the following disclaimer.  
\*  
\* 2. Redistributions in binary form must reproduce the above copyright  
\* notice, this list of conditions and the following disclaimer in  
\* the documentation and/or other materials provided with the  
\* distribution.  
\*  
\* 3. All advertising materials mentioning features or use of this  
\* software must display the following acknowledgment:  
\* "This product includes software developed by the OpenSSL Project  
\* for use in the OpenSSL Toolkit. (<http://www.openssl.org/>)"  
\*  
\* 4. The names "OpenSSL Toolkit" and "OpenSSL Project" must not be used to  
\* endorse or promote products derived from this software without  
\* prior written permission. For written permission, please contact  
\* [openssl-core@openssl.org](mailto:openssl-core@openssl.org).  
\*  
\* 5. Products derived from this software may not be called "OpenSSL"  
\* nor may "OpenSSL" appear in their names without prior written  
\* permission of the OpenSSL Project.  
\*  
\* 6. Redistributions of any form whatsoever must retain the following  
acknowledgment:  
\* "This product includes software developed by the OpenSSL Project  
\* for use in the OpenSSL Toolkit (<http://www.openssl.org/>)"  
\*  
\* THIS SOFTWARE IS PROVIDED BY THE OpenSSL PROJECT ``AS IS'' AND ANY  
EXPRESSED OR IMPLIED WARRANTIES, INCLUDING, BUT NOT LIMITED TO, THE  
IMPLIED WARRANTIES OF MERCHANTABILITY AND FITNESS FOR A PARTICULAR  
PURPOSE ARE DISCLAIMED. IN NO EVENT SHALL THE OpenSSL PROJECT OR ITS  
CONTRIBUTORS BE LIABLE FOR ANY DIRECT, INDIRECT, INCIDENTAL, SPECIAL,  
EXEMPLARY, OR CONSEQUENTIAL DAMAGES (INCLUDING, BUT NOT LIMITED TO,  
PROCUREMENT OF SUBSTITUTE GOODS OR SERVICES; LOSS OF USE, DATA, OR  
PROFITS; OR BUSINESS INTERRUPTION) HOWEVER CAUSED AND ON ANY THEORY  
OF LIABILITY, WHETHER IN CONTRACT, STRICT LIABILITY, OR TORT (INCLUDING  
NEGLIGENCE OR OTHERWISE) ARISING IN ANY WAY OUT OF THE USE OF THIS  
SOFTWARE, EVEN IF ADVISED OF THE POSSIBILITY OF SUCH DAMAGE.  
\*  
=====

```
=
*
* This product includes cryptographic software written by Eric Young
* (eay@cryptsoft.com). This product includes software written by Tim
* Hudson (tjh@cryptsoft.com).
*
*/

Original SSLeay License
-----

/* Copyright (C) 1995-1998 Eric Young (eay@cryptsoft.com)
 * All rights reserved.
 *
 * This package is an SSL implementation written
 * by Eric Young (eay@cryptsoft.com).
 * The implementation was written so as to conform with Netscapes SSL.
 *
 * This library is free for commercial and non-commercial use as long as
 * the following conditions are aheared to. The following conditions
 * apply to all code found in this distribution, be it the RC4, RSA,
 * lhash, DES, etc., code; not just the SSL code. The SSL documentation
 * included with this distribution is covered by the same copyright terms
 * except that the holder is Tim Hudson (tjh@cryptsoft.com).
 *
 * Copyright remains Eric Young's, and as such any Copyright notices in
 * the code are not to be removed.
 * If this package is used in a product, Eric Young should be given attribution
 * as the author of the parts of the library used.
 * This can be in the form of a textual message at program startup or
 * in documentation (online or textual) provided with the package.
 *
 * Redistribution and use in source and binary forms, with or without
 * modification, are permitted provided that the following conditions
 * are met:
 * 1. Redistributions of source code must retain the copyright
 * notice, this list of conditions and the following disclaimer.
 * 2. Redistributions in binary form must reproduce the above copyright
 * notice, this list of conditions and the following disclaimer in the
 * documentation and/or other materials provided with the distribution.
 * 3. All advertising materials mentioning features or use of this software
 * must display the following acknowledgement:
 * "This product includes cryptographic software written by
 * Eric Young (eay@cryptsoft.com)"
 * The word 'cryptographic' can be left out if the rouines from the library
 * being used are not cryptographic related :-).
```



```

* 4. If you include any Windows specific code (or a derivative thereof) from
* the apps directory (application code) you must include an acknowledgement:
* "This product includes software written by Tim Hudson (tjh@cryptsoft.com)"
*
* THIS SOFTWARE IS PROVIDED BY ERIC YOUNG ``AS IS" AND
* ANY EXPRESS OR IMPLIED WARRANTIES, INCLUDING, BUT NOT LIMITED TO,
THE IMPLIED WARRANTIES OF MERCHANTABILITY AND FITNESS FOR A
PARTICULAR PURPOSE ARE DISCLAIMED. IN NO EVENT SHALL THE AUTHOR OR
CONTRIBUTORS BE LIABLE FOR ANY DIRECT, INDIRECT, INCIDENTAL, SPECIAL,
EXEMPLARY, OR CONSEQUENTIAL DAMAGES (INCLUDING, BUT NOT LIMITED TO,
PROCUREMENT OF SUBSTITUTE GOODS OR SERVICES; LOSS OF USE, DATA, OR
PROFITS; OR BUSINESS INTERRUPTION) HOWEVER CAUSED AND ON ANY THEORY
OF LIABILITY, WHETHER IN CONTRACT, STRICT LIABILITY, OR TORT (INCLUDING
NEGLIGENCE OR OTHERWISE) ARISING IN ANY WAY OUT OF THE USE OF THIS
SOFTWARE, EVEN IF ADVISED OF THE POSSIBILITY OF SUCH DAMAGE.
*
* The licence and distribution terms for any publically available version or
* derivative of this code cannot be changed. i.e. this code cannot simply be
* copied and put under another distribution licence
* [including the GNU Public Licence.]
*/

# (C) Copyright 2002-2006
# Wolfgang Denk, DENX Software Engineering, wd@denx.de.
#
# See file CREDITS for list of people who contributed to this
# project.
#
# This program is free software; you can redistribute it and/or
# modify it under the terms of the GNU General Public License as
# published by the Free Software Foundation; either version 2 of
# the License, or (at your option) any later version.
#
# This program is distributed in the hope that it will be useful,
# but WITHOUT ANY WARRANTY; without even the implied warranty of
# MERCHANTABILITY or FITNESS FOR A PARTICULAR PURPOSE. See the
# GNU General Public License for more details.
#
# You should have received a copy of the GNU General Public License
# along with this program; if not, write to the Free Software
# Foundation, Inc., 59 Temple Place, Suite 330, Boston,
# MA 02111-1307 USA
#

```

*opkg*

GNU GENERAL PUBLIC LICENSE  
Version 2, June 1991

Copyright (C) 1989, 1991 Free Software Foundation, Inc.  
59 Temple Place, Suite 330, Boston, MA 02111-1307 USA

Everyone is permitted to copy and distribute verbatim copies of this license document, but changing it is not allowed.

See full license text on page 335.

```
# (C) Copyright 2002-2006
# Wolfgang Denk, DENX Software Engineering, wd@denx.de.
#
# See file CREDITS for list of people who contributed to this
# project.
#
# This program is free software; you can redistribute it and/or
# modify it under the terms of the GNU General Public License as
# published by the Free Software Foundation; either version 2 of
# the License, or (at your option) any later version.
#
# This program is distributed in the hope that it will be useful,
# but WITHOUT ANY WARRANTY; without even the implied warranty of
# MERCHANTABILITY or FITNESS FOR A PARTICULAR PURPOSE. See the
# GNU General Public License for more details.
#
# You should have received a copy of the GNU General Public License
# along with this program; if not, write to the Free Software
# Foundation, Inc., 59 Temple Place, Suite 330, Boston,
# MA 02111-1307 USA
#
```

*pcre*

Copyright (c) 1997-2010 University of Cambridge

Release 8 of PCRE is distributed under the terms of the "BSD" licence, as specified below. The documentation for PCRE, supplied in the "doc" directory, is distributed under the same terms as the software itself.

THE MAIN PCRE LIBRARY

-----

Written by: Philip Hazel  
 Email local part: ph10  
 Email domain: cam.ac.uk  
 University of Cambridge Computing Service,  
 Cambridge, England.  
 Copyright (c) 1997-2010 University of Cambridge  
 All rights reserved

THE C++ WRAPPER LIBRARY

-----

Written by: Google Inc.  
 Copyright (c) 2007-2010 Google Inc  
 All rights reserved

```
# (C) Copyright 2002-2006
# Wolfgang Denk, DENX Software Engineering, wd@denx.de.
#
```

```
# See file CREDITS for list of people who contributed to this
# project.
#
# This program is free software; you can redistribute it and/or
# modify it under the terms of the GNU General Public License as
# published by the Free Software Foundation; either version 2 of
# the License, or (at your option) any later version.
#
# This program is distributed in the hope that it will be useful,
# but WITHOUT ANY WARRANTY; without even the implied warranty of
# MERCHANTABILITY or FITNESS FOR A PARTICULAR PURPOSE. See the
# GNU General Public License for more details.
#
# You should have received a copy of the GNU General Public License
# along with this program; if not, write to the Free Software
# Foundation, Inc., 59 Temple Place, Suite 330, Boston,
# MA 02111-1307 USA
#
```

*procps*

GNU GENERAL PUBLIC LICENSE  
Version 2, June 1991

Copyright (C) 1989, 1991 Free Software Foundation, Inc.  
59 Temple Place, Suite 330, Boston, MA 02111-1307 USA  
Everyone is permitted to copy and distribute verbatim copies  
of this license document, but changing it is not allowed.  
See full license text on page [335](#).

```
# (C) Copyright 2002-2006
# Wolfgang Denk, DENX Software Engineering, wd@denx.de.
#
# See file CREDITS for list of people who contributed to this
# project.
#
# This program is free software; you can redistribute it and/or
# modify it under the terms of the GNU General Public License as
# published by the Free Software Foundation; either version 2 of
# the License, or (at your option) any later version.
#
# This program is distributed in the hope that it will be useful,
# but WITHOUT ANY WARRANTY; without even the implied warranty of
# MERCHANTABILITY or FITNESS FOR A PARTICULAR PURPOSE. See the
# GNU General Public License for more details.
#
# You should have received a copy of the GNU General Public License
# along with this program; if not, write to the Free Software
# Foundation, Inc., 59 Temple Place, Suite 330, Boston,
# MA 02111-1307 USA
#
```

*px5g*

Copyright (C) 2009 Steven Barth <steven@midlink.org>  
Copyright (C) 2009 Paul Bakker <polarssl\_maintainer at polarssl dot org>  
Copyright (C) 2006-2007 Pascal Vizeli <pvizeli@yahoo.de>

This library is free software; you can redistribute it and/or  
Modify it under the terms of the GNU Lesser General Public  
License, version 2.1 as published by the Free Software Foundation.

This library is distributed in the hope that it will be useful,  
but WITHOUT ANY WARRANTY; without even the implied warranty of  
MERCHANTABILITY or FITNESS FOR A PARTICULAR PURPOSE. See the GNU  
Lesser General Public License for more details.

See full license text on page [357](#).

```
# (C) Copyright 2002-2006
# Wolfgang Denk, DENX Software Engineering, wd@denx.de.
#
# See file CREDITS for list of people who contributed to this
# project.
#
# This program is free software; you can redistribute it and/or
# modify it under the terms of the GNU General Public License as
# published by the Free Software Foundation; either version 2 of
# the License, or (at your option) any later version.
#
# This program is distributed in the hope that it will be useful,
# but WITHOUT ANY WARRANTY; without even the implied warranty of
# MERCHANTABILITY or FITNESS FOR A PARTICULAR PURPOSE. See the
# GNU General Public License for more details.
#
# You should have received a copy of the GNU General Public License
# along with this program; if not, write to the Free Software
# Foundation, Inc., 59 Temple Place, Suite 330, Boston,
# MA 02111-1307 USA
#
```

*relayed*

Copyright (C) 2010-2011 [OpenWrt.org](http://OpenWrt.org)

This is free software, licensed under the GNU General Public License v2.  
See /LICENSE for more information.

See full license text on page [335](#).

```
# (C) Copyright 2002-2006
# Wolfgang Denk, DENX Software Engineering, wd@denx.de.
#
# See file CREDITS for list of people who contributed to this
# project.
#
# This program is free software; you can redistribute it and/or
# modify it under the terms of the GNU General Public License as
# published by the Free Software Foundation; either version 2 of
# the License, or (at your option) any later version.
```

	<pre># # This program is distributed in the hope that it will be useful, # but WITHOUT ANY WARRANTY; without even the implied warranty of # MERCHANTABILITY or FITNESS FOR A PARTICULAR PURPOSE. See the # GNU General Public License for more details. # # You should have received a copy of the GNU General Public License # along with this program; if not, write to the Free Software # Foundation, Inc., 59 Temple Place, Suite 330, Boston, # MA 02111-1307 USA #</pre>
<i>swconfig</i>	<pre>Copyright (C) 2008-2009 Felix Fietkau &lt;nbd@openwrt.org&gt; Copyright (C) 2010 Martin Mares &lt;mj@ucw.cz&gt;  # # Copyright (C) 2008-2010 OpenWrt.org # # This is free software, licensed under the GNU General Public License v2. # See /LICENSE for more information. #  See full license text on page <a href="#">335</a>.  # (C) Copyright 2002-2006 # Wolfgang Denk, DENX Software Engineering, wd@denx.de. # # See file CREDITS for list of people who contributed to this # project. # # This program is free software; you can redistribute it and/or # modify it under the terms of the GNU General Public License as # published by the Free Software Foundation; either version 2 of # the License, or (at your option) any later version. # # This program is distributed in the hope that it will be useful, # but WITHOUT ANY WARRANTY; without even the implied warranty of # MERCHANTABILITY or FITNESS FOR A PARTICULAR PURPOSE. See the # GNU General Public License for more details. # # You should have received a copy of the GNU General Public License # along with this program; if not, write to the Free Software # Foundation, Inc., 59 Temple Place, Suite 330, Boston, # MA 02111-1307 USA #</pre>
<i>Syslog-ng</i>	<pre>GNU GENERAL PUBLIC LICENSE Version 2, June 1991  See full license text on page <a href="#">335</a>.  # (C) Copyright 2002-2006 # Wolfgang Denk, DENX Software Engineering, wd@denx.de.</pre>

	<pre> # # See file CREDITS for list of people who contributed to this # project. # # This program is free software; you can redistribute it and/or # modify it under the terms of the GNU General Public License as # published by the Free Software Foundation; either version 2 of # the License, or (at your option) any later version. # # This program is distributed in the hope that it will be useful, # but WITHOUT ANY WARRANTY; without even the implied warranty of # MERCHANTABILITY or FITNESS FOR A PARTICULAR PURPOSE. See the # GNU General Public License for more details. # # You should have received a copy of the GNU General Public License # along with this program; if not, write to the Free Software # Foundation, Inc., 59 Temple Place, Suite 330, Boston, # MA 02111-1307 USA # </pre>
<i>tcp_wrappers</i>	<pre> Copyright 1995 by Wietse Venema. All rights reserved. Some individual files may be covered by other copyrights. Copyright (c) 1987 Regents of the University of California. All rights reserved.  /***** **** * Copyright 1995 by Wietse Venema. All rights reserved. Some individual * files may be covered by other copyrights. * * This material was originally written and compiled by Wietse Venema at * Eindhoven University of Technology, The Netherlands, in 1990, 1991, * 1992, 1993, 1994 and 1995. * * Redistribution and use in source and binary forms, with or without * modification, are permitted provided that this entire copyright notice * is duplicated in all such copies. * * This software is provided "as is" and without any expressed or implied * warranties, including, without limitation, the implied warranties of * merchantability and fitness for any particular purpose. *****/  # (C) Copyright 2002-2006 # Wolfgang Denk, DENX Software Engineering, wd@denx.de. # # See file CREDITS for list of people who contributed to this # project. # # This program is free software; you can redistribute it and/or # modify it under the terms of the GNU General Public License as </pre>

---

	<pre># published by the Free Software Foundation; either version 2 of # the License, or (at your option) any later version. # # This program is distributed in the hope that it will be useful, # but WITHOUT ANY WARRANTY; without even the implied warranty of # MERCHANTABILITY or FITNESS FOR A PARTICULAR PURPOSE. See the # GNU General Public License for more details. # # You should have received a copy of the GNU General Public License # along with this program; if not, write to the Free Software # Foundation, Inc., 59 Temple Place, Suite 330, Boston, # MA 02111-1307 USA #</pre>
<i>tcpdump</i>	<pre>Copyright (c) 2001 Seth Webster &lt;swester@sst.ll.mit.edu&gt; Copyright (C) Andrew Tridgell 1995-1999 Copyright (c) 1988, 1989, 1990, 1991, 1992, 1993, 1994, 1995, 1996, 1997, 2000 The Regents of the University of California. All rights reserved.  License: BSD  Redistribution and use in source and binary forms, with or without modification, are permitted provided that the following conditions are met:  1. Redistributions of source code must retain the above copyright    notice, this list of conditions and the following disclaimer. 2. Redistributions in binary form must reproduce the above copyright    notice, this list of conditions and the following disclaimer in    the documentation and/or other materials provided with the    distribution. 3. The names of the authors may not be used to endorse or promote    products derived from this software without specific prior    written permission.  THIS SOFTWARE IS PROVIDED ``AS IS'' AND WITHOUT ANY EXPRESS OR IMPLIED WARRANTIES, INCLUDING, WITHOUT LIMITATION, THE IMPLIED WARRANTIES OF MERCHANTABILITY AND FITNESS FOR A PARTICULAR PURPOSE.  # (C) Copyright 2002-2006 # Wolfgang Denk, DENX Software Engineering, wd@denx.de. # # See file CREDITS for list of people who contributed to this # project. # # This program is free software; you can redistribute it and/or # modify it under the terms of the GNU General Public License as # published by the Free Software Foundation; either version 2 of # the License, or (at your option) any later version.</pre>

---

---

	<pre># # This program is distributed in the hope that it will be useful, # but WITHOUT ANY WARRANTY; without even the implied warranty of # MERCHANTABILITY or FITNESS FOR A PARTICULAR PURPOSE. See the # GNU General Public License for more details. # # You should have received a copy of the GNU General Public License # along with this program; if not, write to the Free Software # Foundation, Inc., 59 Temple Place, Suite 330, Boston, # MA 02111-1307 USA #</pre>
<i>uClibc++</i>	<pre> LGPL v2.1  See full license text on page 357.  GPL v2  See full license text on page 335.  # (C) Copyright 2002-2006 # Wolfgang Denk, DENX Software Engineering, wd@denx.de. # # See file CREDITS for list of people who contributed to this # project. # # This program is free software; you can redistribute it and/or # modify it under the terms of the GNU General Public License as # published by the Free Software Foundation; either version 2 of # the License, or (at your option) any later version. # # This program is distributed in the hope that it will be useful, # but WITHOUT ANY WARRANTY; without even the implied warranty of # MERCHANTABILITY or FITNESS FOR A PARTICULAR PURPOSE. See the # GNU General Public License for more details. # # You should have received a copy of the GNU General Public License # along with this program; if not, write to the Free Software # Foundation, Inc., 59 Temple Place, Suite 330, Boston, # MA 02111-1307 USA #</pre>

---



*Uboot-envtools*

```
#
# (C) Copyright 2002-2006
# Wolfgang Denk, DENX Software Engineering, wd@denx.de.
#
# See file CREDITS for list of people who contributed to this
# project.
#
# This program is free software; you can redistribute it and/or
# modify it under the terms of the GNU General Public License as
# published by the Free Software Foundation; either version 2 of
# the License, or (at your option) any later version.
#
# This program is distributed in the hope that it will be useful,
# but WITHOUT ANY WARRANTY; without even the implied warranty of
# MERCHANTABILITY or FITNESS FOR A PARTICULAR PURPOSE. See the
# GNU General Public License for more details.
#
# You should have received a copy of the GNU General Public License
# along with this program; if not, write to the Free Software
# Foundation, Inc., 59 Temple Place, Suite 330, Boston,
# MA 02111-1307 USA
#
See full license text on page 335.
/* resolv.c: DNS Resolver
 *
 * Copyright (C) 1998 Kenneth Albanowski <kjahds@kjahds.com>,
 * The Silver Hammer Group, Ltd.
 *
 * This library is free software; you can redistribute it and/or
 * modify it under the terms of the GNU Library General Public
 * License as published by the Free Software Foundation; either
 * version 2 of the License, or (at your option) any later version.
 */
/*
 * Portions Copyright (c) 1985, 1993
 * The Regents of the University of California. All rights reserved.
 *
 * Redistribution and use in source and binary forms, with or without
 * modification, are permitted provided that the following conditions
 * are met:
 * 1. Redistributions of source code must retain the above copyright
 * notice, this list of conditions and the following disclaimer.
 * 2. Redistributions in binary form must reproduce the above copyright
 * notice, this list of conditions and the following disclaimer in the
 * documentation and/or other materials provided with the distribution.
 * 4. Neither the name of the University nor the names of its contributors
 * may be used to endorse or promote products derived from this software
 * without specific prior written permission.
 *
 * THIS SOFTWARE IS PROVIDED BY THE REGENTS AND CONTRIBUTORS ``AS IS'' AND
 * ANY EXPRESS OR IMPLIED WARRANTIES, INCLUDING, BUT NOT LIMITED TO, THE
 * IMPLIED WARRANTIES OF MERCHANTABILITY AND FITNESS FOR A PARTICULAR
 * PURPOSE
```

\* ARE DISCLAIMED. IN NO EVENT SHALL THE REGENTS OR CONTRIBUTORS BE LIABLE  
\* FOR ANY DIRECT, INDIRECT, INCIDENTAL, SPECIAL, EXEMPLARY, OR CONSEQUENTIAL  
\* DAMAGES (INCLUDING, BUT NOT LIMITED TO, PROCUREMENT OF SUBSTITUTE GOODS  
\* OR SERVICES; LOSS OF USE, DATA, OR PROFITS; OR BUSINESS INTERRUPTION)  
\* HOWEVER CAUSED AND ON ANY THEORY OF LIABILITY, WHETHER IN CONTRACT,  
STRICT  
\* LIABILITY, OR TORT (INCLUDING NEGLIGENCE OR OTHERWISE) ARISING IN ANY WAY  
\* OUT OF THE USE OF THIS SOFTWARE, EVEN IF ADVISED OF THE POSSIBILITY OF  
\* SUCH DAMAGE.

\*/  
/\*

\* Portions Copyright (c) 1993 by Digital Equipment Corporation.

\*

\* Permission to use, copy, modify, and distribute this software for any  
\* purpose with or without fee is hereby granted, provided that the above  
\* copyright notice and this permission notice appear in all copies, and that  
\* the name of Digital Equipment Corporation not be used in advertising or  
\* publicity pertaining to distribution of the document or software without  
\* specific, written prior permission.

\*

\* THE SOFTWARE IS PROVIDED "AS IS" AND DIGITAL EQUIPMENT CORP. DISCLAIMS ALL  
\* WARRANTIES WITH REGARD TO THIS SOFTWARE, INCLUDING ALL IMPLIED

WARRANTIES

\* OF MERCHANTABILITY AND FITNESS. IN NO EVENT SHALL DIGITAL EQUIPMENT  
\* CORPORATION BE LIABLE FOR ANY SPECIAL, DIRECT, INDIRECT, OR CONSEQUENTIAL  
\* DAMAGES OR ANY DAMAGES WHATSOEVER RESULTING FROM LOSS OF USE, DATA OR  
\* PROFITS, WHETHER IN AN ACTION OF CONTRACT, NEGLIGENCE OR OTHER TORTIOUS  
\* ACTION, ARISING OUT OF OR IN CONNECTION WITH THE USE OR PERFORMANCE OF

THIS

\* SOFTWARE.

\*/

/\*

\* Portions Copyright (c) 1996-1999 by Internet Software Consortium.

\*

\* Permission to use, copy, modify, and distribute this software for any  
\* purpose with or without fee is hereby granted, provided that the above  
\* copyright notice and this permission notice appear in all copies.

\*

\* THE SOFTWARE IS PROVIDED "AS IS" AND INTERNET SOFTWARE CONSORTIUM  
DISCLAIMS

\* ALL WARRANTIES WITH REGARD TO THIS SOFTWARE INCLUDING ALL IMPLIED  
WARRANTIES

\* OF MERCHANTABILITY AND FITNESS. IN NO EVENT SHALL INTERNET SOFTWARE  
\* CONSORTIUM BE LIABLE FOR ANY SPECIAL, DIRECT, INDIRECT, OR CONSEQUENTIAL  
\* DAMAGES OR ANY DAMAGES WHATSOEVER RESULTING FROM LOSS OF USE, DATA OR  
\* PROFITS, WHETHER IN AN ACTION OF CONTRACT, NEGLIGENCE OR OTHER TORTIOUS  
\* ACTION, ARISING OUT OF OR IN CONNECTION WITH THE USE OR PERFORMANCE OF

THIS

\* SOFTWARE.

\*/

*uwsgi*

## LINKING EXCEPTION

In addition to the permissions in the GNU General Public License, the authors give you unlimited permission to link the compiled version of this library into combinations with other programs, and to distribute those combinations without any restriction coming from the use of this file. (The General Public License restrictions do apply in other respects; for example, they cover modification of the file, and distribution when not linked into a combined executable.)

---

GNU GENERAL PUBLIC LICENSE  
Version 2, June 1991

Copyright (C) 1989, 1991 Free Software Foundation, Inc.,  
51 Franklin Street, Fifth Floor, Boston, MA 02110-1301 USA  
Everyone is permitted to copy and distribute verbatim copies of this license document, but changing it is not allowed.

See full license text on page [335](#).

```
# (C) Copyright 2002-2006
# Wolfgang Denk, DENX Software Engineering, wd@denx.de.
#
# See file CREDITS for list of people who contributed to this
# project.
#
# This program is free software; you can redistribute it and/or
# modify it under the terms of the GNU General Public License as
# published by the Free Software Foundation; either version 2 of
# the License, or (at your option) any later version.
#
# This program is distributed in the hope that it will be useful,
# but WITHOUT ANY WARRANTY; without even the implied warranty of
# MERCHANTABILITY or FITNESS FOR A PARTICULAR PURPOSE. See the
# GNU General Public License for more details.
#
# You should have received a copy of the GNU General Public License
# along with this program; if not, write to the Free Software
# Foundation, Inc., 59 Temple Place, Suite 330, Boston,
# MA 02111-1307 USA
#
```

*PPPd and PPPoE*

Copyright to Michal Ostrowski for PPPoE and Paul Mackerras [paulus@samba.org](mailto:paulus@samba.org)

## PPPoE

The PPPoE plugin included in this package is a component of the Roaring Penguin PPPoE package, included in this package courtesy of Roaring Penguin Software. (<http://www.roaringpenguin.com>).

## PPPd

## Copyrights:

\*\*\*\*\*

All of the code can be freely used and redistributed. The individual source files each have their own copyright and permission notice.

Pppd, pppstats and pppdump are under BSD-style notices. Some of the pppd plugins are GPL'd. Chat is public domain.

## Distribution:

\*\*\*\*\*

The primary site for releases of this software is:

<ftp://ftp.samba.org/pub/ppp/>

(\$Id: README,v 1.37 2006/05/29 23:51:29 paulus Exp \$)

James Carlson <[carlson@workingcode.com](mailto:carlson@workingcode.com)> for PPPd

See full license text on page **335**.

# (C) Copyright 2002-2006

# Wolfgang Denk, DENX Software Engineering, wd@denx.de.

#

# See file CREDITS for list of people who contributed to this  
# project.

#

# This program is free software; you can redistribute it and/or  
# modify it under the terms of the GNU General Public License as  
# published by the Free Software Foundation; either version 2 of

	<pre># the License, or (at your option) any later version. # # This program is distributed in the hope that it will be useful, # but WITHOUT ANY WARRANTY; without even the implied warranty of # MERCHANTABILITY or FITNESS FOR A PARTICULAR PURPOSE. See the # GNU General Public License for more details. # # You should have received a copy of the GNU General Public License # along with this program; if not, write to the Free Software # Foundation, Inc., 59 Temple Place, Suite 330, Boston, # MA 02111-1307 USA #</pre>
<i>uci</i>	<pre>Copyright (C) 2008-2010 OpenWrt.org Copyright (C) 2008 Felix Fietkau <a href="mailto:ncbd@openwrt.org">ncbd@openwrt.org</a> Copyright (C) 2006 Fokus Fraunhofer &lt;carsten.tittel@fokus.fraunhofer.de  /*  * libuci - Library for the Unified Configuration Interface  * Copyright (C) 2008 Felix Fietkau &lt;ncbd@openwrt.org&gt;  *  * This program is free software; you can redistribute it and/or modify  * it under the terms of the GNU Lesser General Public License version 2.1  * as published by the Free Software Foundation  *  * This program is distributed in the hope that it will be useful,  * but WITHOUT ANY WARRANTY; without even the implied warranty of  * MERCHANTABILITY or FITNESS FOR A PARTICULAR PURPOSE. See the  * GNU General Public License for more details.  */  /*  * ucimap-example - sample code for the ucimap library  * Copyright (C) 2008-2009 Felix Fietkau &lt;ncbd@openwrt.org&gt;  *  * This program is free software; you can redistribute it and/or modify  * it under the terms of the GNU General Public License version 2  * as published by the Free Software Foundation  *  * This program is distributed in the hope that it will be useful,  * but WITHOUT ANY WARRANTY; without even the implied warranty of  * MERCHANTABILITY or FITNESS FOR A PARTICULAR PURPOSE. See the  * GNU General Public License for more details.  */  See full license text on page <a href="#">357</a>.  # (C) Copyright 2002-2006 # Wolfgang Denk, DENX Software Engineering, wd@denx.de. #</pre>

	<pre> # See file CREDITS for list of people who contributed to this # project. # # This program is free software; you can redistribute it and/or # modify it under the terms of the GNU General Public License as # published by the Free Software Foundation; either version 2 of # the License, or (at your option) any later version. # # This program is distributed in the hope that it will be useful, # but WITHOUT ANY WARRANTY; without even the implied warranty of # MERCHANTABILITY or FITNESS FOR A PARTICULAR PURPOSE. See the # GNU General Public License for more details. # # You should have received a copy of the GNU General Public License # along with this program; if not, write to the Free Software # Foundation, Inc., 59 Temple Place, Suite 330, Boston, # MA 02111-1307 USA # </pre>
<p><i>udevttigger</i></p>	<pre> Copyright (C) 2003 Greg Kroah-Hartman &lt;greg@kroah.com&gt; Copyright (C) 2005-2006 Kay Sievers &lt;kay.sievers@vrfy.org&gt; Copyright (C) 2004 Daniel Walsh Copyright (C) 2004 Ling, Xiaofeng &lt;xiaofeng.ling@intel.com&gt; Copyright (C) 2006 Hannes Reinecke <a href="mailto:hare@suse.de">hare@suse.de</a>  /*  * Copyright (C) 2005-2006 Kay Sievers &lt;kay.sievers@vrfy.org&gt;  *  * This program is free software; you can redistribute it and/or modify it  * under the terms of the GNU General Public License as published by the  * Free Software Foundation version 2 of the License.  *  * This program is distributed in the hope that it will be useful, but  * WITHOUT ANY WARRANTY; without even the implied warranty of  * MERCHANTABILITY or FITNESS FOR A PARTICULAR PURPOSE. See the GNU  * General Public License for more details.  *  * You should have received a copy of the GNU General Public License along  * with this program; if not, write to the Free Software Foundation, Inc.,  * 51 Franklin Street, Fifth Floor, Boston, MA 02110-1301, USA.  */  See full license text on page <a href="#">335</a>.  # (C) Copyright 2002-2006 # Wolfgang Denk, DENX Software Engineering, wd@denx.de. # # See file CREDITS for list of people who contributed to this # project. # </pre>

```
# This program is free software; you can redistribute it and/or
# modify it under the terms of the GNU General Public License as
# published by the Free Software Foundation; either version 2 of
# the License, or (at your option) any later version.
#
# This program is distributed in the hope that it will be useful,
# but WITHOUT ANY WARRANTY; without even the implied warranty of
# MERCHANTABILITY or FITNESS FOR A PARTICULAR PURPOSE. See the
# GNU General Public License for more details.
#
# You should have received a copy of the GNU General Public License
# along with this program; if not, write to the Free Software
# Foundation, Inc., 59 Temple Place, Suite 330, Boston,
# MA 02111-1307 USA
#
```

*uhttpd*

Apache License, Version 2.0

```
/*
 * uhttpd - Tiny single-threaded httpd - Main component
 *
 * Copyright (C) 2010 Jo-Philipp Wich <xm@subsignal.org>
 *
 * Licensed under the Apache License, Version 2.0 (the "License");
 * you may not use this file except in compliance with the License.
 * You may obtain a copy of the License at
 *
 * http://www.apache.org/licenses/LICENSE-2.0
 *
 * Unless required by applicable law or agreed to in writing, software
 * distributed under the License is distributed on an "AS IS" BASIS,
 * WITHOUT WARRANTIES OR CONDITIONS OF ANY KIND, either express or
 * implied.
 * See the License for the specific language governing permissions and
 * limitations under the License.
 */
```

```
# (C) Copyright 2002-2006
# Wolfgang Denk, DENX Software Engineering, wd@denx.de.
#
```

```
# See file CREDITS for list of people who contributed to this
# project.
```

```
#
# This program is free software; you can redistribute it and/or
# modify it under the terms of the GNU General Public License as
# published by the Free Software Foundation; either version 2 of
# the License, or (at your option) any later version.
```

```
#
# This program is distributed in the hope that it will be useful,
```

```
# but WITHOUT ANY WARRANTY; without even the implied warranty of
# MERCHANTABILITY or FITNESS FOR A PARTICULAR PURPOSE. See the
# GNU General Public License for more details.
#
# You should have received a copy of the GNU General Public License
# along with this program; if not, write to the Free Software
# Foundation, Inc., 59 Temple Place, Suite 330, Boston,
# MA 02111-1307 USA
#
```

*wget v 1.10.2*

```
Copyright (C) 1995, 1996, 1997, 1998, 2003 Free Software Foundation, Inc.
```

```
#
```

```
# Copyright (C) 2006-2012 OpenWrt.org
```

```
#
```

```
# This is free software, licensed under the GNU General Public License v2.
```

```
# See /LICENSE for more information.
```

```
#
```

```
Copyright (c) 2004, Jan Kneschke, incremental
```

```
All rights reserved.
```

```
Redistribution and use in source and binary forms, with or without
modification, are permitted provided that the following conditions are met:
```

```
- Redistributions of source code must retain the above copyright notice, this
list of conditions and the following disclaimer.
```

```
- Redistributions in binary form must reproduce the above copyright notice,
this list of conditions and the following disclaimer in the documentation
and/or other materials provided with the distribution.
```

```
- Neither the name of the 'incremental' nor the names of its contributors may
```



be used to endorse or promote products derived from this software without specific prior written permission.

THIS SOFTWARE IS PROVIDED BY THE COPYRIGHT HOLDERS AND CONTRIBUTORS "AS IS"

AND ANY EXPRESS OR IMPLIED WARRANTIES, INCLUDING, BUT NOT LIMITED TO, THE

IMPLIED WARRANTIES OF MERCHANTABILITY AND FITNESS FOR A PARTICULAR PURPOSE

ARE DISCLAIMED. IN NO EVENT SHALL THE COPYRIGHT OWNER OR CONTRIBUTORS BE

LIABLE FOR ANY DIRECT, INDIRECT, INCIDENTAL, SPECIAL, EXEMPLARY, OR

CONSEQUENTIAL DAMAGES (INCLUDING, BUT NOT LIMITED TO, PROCUREMENT OF

SUBSTITUTE GOODS OR SERVICES; LOSS OF USE, DATA, OR PROFITS; OR BUSINESS

INTERRUPTION) HOWEVER CAUSED AND ON ANY THEORY OF LIABILITY, WHETHER IN

CONTRACT, STRICT LIABILITY, OR TORT (INCLUDING NEGLIGENCE OR OTHERWISE)

ARISING IN ANY WAY OUT OF THE USE OF THIS SOFTWARE, EVEN IF ADVISED OF

THE POSSIBILITY OF SUCH DAMAGE.

# (C) Copyright 2002-2006

# Wolfgang Denk, DENX Software Engineering, wd@denx.de.

#

# See file CREDITS for list of people who contributed to this

# project.

#

# This program is free software; you can redistribute it and/or

# modify it under the terms of the GNU General Public License as

# published by the Free Software Foundation; either version 2 of

# the License, or (at your option) any later version.

#

# This program is distributed in the hope that it will be useful,

# but WITHOUT ANY WARRANTY; without even the implied warranty of

# MERCHANTABILITY or FITNESS FOR A PARTICULAR PURPOSE. See the

# GNU General Public License for more details.

#

# You should have received a copy of the GNU General Public License

# along with this program; if not, write to the Free Software

# Foundation, Inc., 59 Temple Place, Suite 330, Boston,

```
# MA 02111-1307 USA
#
```

*Wireless-tools*

```
Copyright (c) 1997-2007 Jean Tourrilhes <jt@hpl.hp.com>
```

```
(Ref: wireless_tools.29/COPYING)
```

```
GNU GENERAL PUBLIC LICENSE
Version 2, June 1991
```

```
Copyright (C) 1989, 1991 Free Software Foundation, Inc.
  59 Temple Place, Suite 330, Boston, MA 02111-1307 USA
Everyone is permitted to copy and distribute verbatim copies
of this license document, but changing it is not allowed.
```

```
See full license text on page 335.
```

```
# (C) Copyright 2002-2006
# Wolfgang Denk, DENX Software Engineering, wd@denx.de.
#
# See file CREDITS for list of people who contributed to this
# project.
#
# This program is free software; you can redistribute it and/or
# modify it under the terms of the GNU General Public License as
# published by the Free Software Foundation; either version 2 of
# the License, or (at your option) any later version.
#
# This program is distributed in the hope that it will be useful,
# but WITHOUT ANY WARRANTY; without even the implied warranty of
# MERCHANTABILITY or FITNESS FOR A PARTICULAR PURPOSE. See the
# GNU General Public License for more details.
#
# You should have received a copy of the GNU General Public License
# along with this program; if not, write to the Free Software
# Foundation, Inc., 59 Temple Place, Suite 330, Boston,
# MA 02111-1307 USA
#
```

*zlib*

(C) 1995-2004 Jean-loup Gailly and Mark Adler  
jloup@gzip.org      [madler@alumni.caltech.edu](mailto:madler@alumni.caltech.edu)

This software is provided 'as-is', without any express or implied warranty. In no event will the authors be held liable for any damages arising from the use of this software.

Permission is granted to anyone to use this software for any purpose, including commercial applications, and to alter it and redistribute it freely, subject to the following restrictions:

1. The origin of this software must not be misrepresented; you must not claim that you wrote the original software. If you use this software in a product, an acknowledgment in the product documentation would be appreciated but is not required.
2. Altered source versions must be plainly marked as such, and must not be misrepresented as being the original software.
3. This notice may not be removed or altered from any source distribution.

Jean-loup Gailly      Mark Adler  
jloup@gzip.org      [madler@alumni.caltech.edu](mailto:madler@alumni.caltech.edu)

```
# (C) Copyright 2002-2006
# Wolfgang Denk, DENX Software Engineering, wd@denx.de.
#
# See file CREDITS for list of people who contributed to this
# project.
#
# This program is free software; you can redistribute it and/or
# modify it under the terms of the GNU General Public License as
# published by the Free Software Foundation; either version 2 of
# the License, or (at your option) any later version.
#
# This program is distributed in the hope that it will be useful,
# but WITHOUT ANY WARRANTY; without even the implied warranty of
# MERCHANTABILITY or FITNESS FOR A PARTICULAR PURPOSE. See the
# GNU General Public License for more details.
#
# You should have received a copy of the GNU General Public License
# along with this program; if not, write to the Free Software
# Foundation, Inc., 59 Temple Place, Suite 330, Boston,
# MA 02111-1307 USA
#
```

*lighttpd*

```
#
# Copyright (C) 2006-2012 OpenWrt.org
#
# This is free software, licensed under the GNU General Public License v2.
# See /LICENSE for more information.
#

See full license text on page 335.

Copyright (c) 2004, Jan Kneschke, incremental
All rights reserved.

Redistribution and use in source and binary forms, with or without modification,
are permitted provided that the following conditions are met:

- Redistributions of source code must retain the above copyright notice, this list of
conditions and the following disclaimer.

- Redistributions in binary form must reproduce the above copyright notice, this
list of conditions and the following disclaimer in the documentation and/or other
materials provided with the distribution.

- Neither the name of the 'incremental' nor the names of its contributors may be
used to endorse or promote products derived from this software without specific
prior written permission.

THIS SOFTWARE IS PROVIDED BY THE COPYRIGHT HOLDERS AND CONTRIBUTORS
"AS IS" AND ANY EXPRESS OR IMPLIED WARRANTIES, INCLUDING, BUT NOT
LIMITED TO, THE IMPLIED WARRANTIES OF MERCHANTABILITY AND FITNESS FOR
A PARTICULAR PURPOSE ARE DISCLAIMED. IN NO EVENT SHALL THE COPYRIGHT
OWNER OR CONTRIBUTORS BE LIABLE FOR ANY DIRECT, INDIRECT, INCIDENTAL,
SPECIAL, EXEMPLARY, OR CONSEQUENTIAL DAMAGES (INCLUDING, BUT NOT
LIMITED TO, PROCUREMENT OF SUBSTITUTE GOODS OR SERVICES; LOSS OF USE,
DATA, OR PROFITS; OR BUSINESS INTERRUPTION) HOWEVER CAUSED AND ON
ANY THEORY OF LIABILITY, WHETHER IN CONTRACT, STRICT LIABILITY, OR TORT
(INCLUDING NEGLIGENCE OR OTHERWISE) ARISING IN ANY WAY OUT OF THE USE
OF THIS SOFTWARE, EVEN IF ADVISED OF THE POSSIBILITY OF SUCH DAMAGE.

# (C) Copyright 2002-2006
# Wolfgang Denk, DENX Software Engineering, wd@denx.de.
#
# See file CREDITS for list of people who contributed to this
# project.
#
# This program is free software; you can redistribute it and/or
# modify it under the terms of the GNU General Public License as
# published by the Free Software Foundation; either version 2 of
```

```
# the License, or (at your option) any later version.
#
# This program is distributed in the hope that it will be useful,
# but WITHOUT ANY WARRANTY; without even the implied warranty of
# MERCHANTABILITY or FITNESS FOR A PARTICULAR PURPOSE. See the
# GNU General Public License for more details.
#
# You should have received a copy of the GNU General Public License
# along with this program; if not, write to the Free Software
# Foundation, Inc., 59 Temple Place, Suite 330, Boston,
# MA 02111-1307 USA
#
```

*klis*

Copyright (c) 2005, 3Com Corporation

Copyright (c) 2005,2006, Newport Networks Ltd

Copyright (c) 2010 Serj Kalichev

=====

#### Overview

This package contains code which is copyrighted to multiple sources.

=====

#### 3Com Corporation

The initial public release of this software was developed by Graeme McKerrill whilst in the employment of 3Com Europe Ltd.

Copyright (c) 2005, 3Com Corporation

All rights reserved.

Redistribution and use in source and binary forms, with or without modification, are permitted provided that the following conditions are met:

- \* Redistributions of source code must retain the above copyright notice, this list of conditions and the following disclaimer.

- \* Redistributions in binary form must reproduce the above copyright notice, this list of conditions and the following disclaimer in the documentation and/or other materials provided with the distribution.

\* Neither the name of 3Com Corporation nor the names of its contributors may be used to endorse or promote products derived from this software without specific prior written permission.

THIS SOFTWARE IS PROVIDED BY THE COPYRIGHT HOLDERS AND CONTRIBUTORS "AS IS" AND ANY EXPRESS OR IMPLIED WARRANTIES, INCLUDING, BUT NOT LIMITED TO, THE IMPLIED WARRANTIES OF MERCHANTABILITY AND FITNESS FOR A PARTICULAR PURPOSE ARE DISCLAIMED. IN NO EVENT SHALL THE COPYRIGHT OWNER OR CONTRIBUTORS BE LIABLE FOR ANY DIRECT, INDIRECT, INCIDENTAL, SPECIAL, EXEMPLARY, OR CONSEQUENTIAL DAMAGES (INCLUDING, BUT NOT LIMITED TO, PROCUREMENT OF SUBSTITUTE GOODS OR SERVICES; LOSS OF USE, DATA, OR PROFITS; OR BUSINESS INTERRUPTION) HOWEVER CAUSED AND ON ANY THEORY OF LIABILITY, WHETHER IN CONTRACT, STRICT LIABILITY, OR TORT (INCLUDING NEGLIGENCE OR OTHERWISE) ARISING IN ANY WAY OUT OF THE USE OF THIS SOFTWARE, EVEN IF ADVISED OF THE POSSIBILITY OF SUCH DAMAGE.

=====

Newport Networks Ltd.

The 0.6-0.7 releases of this software was developed by Graeme McKerrell whilst in the employment of Newport Networks Ltd. As well as enhancing the existing code the new modules were developed.

Copyright (c) 2005,2006, Newport Networks Ltd

All rights reserved.

Redistribution and use in source and binary forms, with or without modification, are permitted provided that the following conditions are met:

\* Redistributions of source code must retain the above copyright notice, this list of conditions and the following disclaimer.

\* Redistributions in binary form must reproduce the above copyright notice, this list of conditions and the following disclaimer in the documentation and/or other materials provided with the distribution.

\* Neither the name of Newport Networks Ltd nor the names of its contributors may be used to endorse or promote products derived from this software without specific prior written permission.

THIS SOFTWARE IS PROVIDED BY THE COPYRIGHT HOLDERS AND CONTRIBUTORS "AS IS" AND ANY EXPRESS OR IMPLIED WARRANTIES, INCLUDING, BUT NOT LIMITED TO, THE IMPLIED WARRANTIES OF MERCHANTABILITY AND FITNESS FOR A PARTICULAR PURPOSE ARE DISCLAIMED. IN NO EVENT SHALL THE COPYRIGHT OWNER OR CONTRIBUTORS BE LIABLE FOR ANY DIRECT, INDIRECT, INCIDENTAL, SPECIAL, EXEMPLARY, OR CONSEQUENTIAL DAMAGES (INCLUDING, BUT NOT LIMITED TO, PROCUREMENT OF SUBSTITUTE GOODS OR SERVICES; LOSS OF USE, DATA, OR PROFITS; OR BUSINESS INTERRUPTION) HOWEVER CAUSED AND ON

ANY THEORY OF LIABILITY, WHETHER IN CONTRACT, STRICT LIABILITY, OR TORT (INCLUDING NEGLIGENCE OR OTHERWISE) ARISING IN ANY WAY OUT OF THE USE OF THIS SOFTWARE, EVEN IF ADVISED OF THE POSSIBILITY OF SUCH DAMAGE.

=====

Serj Kalichev

The klish is a fork of original clish.

Copyright (c) 2010 Serj Kalichev.

All Rights Reserved.

Redistribution and use in source and binary forms, with or without modification, are permitted provided that the following conditions are met:

1. Redistributions of source code must retain the above copyright notice, this list of conditions and the following disclaimer.
2. Redistributions in binary form must reproduce the above copyright notice, this list of conditions and the following disclaimer in the documentation and/or other materials provided with the distribution.
3. The name of the author may not be used to endorse or promote products derived from this software without specific prior written permission.

THIS SOFTWARE IS PROVIDED BY THE COPYRIGHT HOLDERS AND CONTRIBUTORS "AS IS" AND ANY EXPRESS OR IMPLIED WARRANTIES, INCLUDING, BUT NOT LIMITED TO, THE IMPLIED WARRANTIES OF MERCHANTABILITY AND FITNESS FOR A PARTICULAR PURPOSE ARE DISCLAIMED. IN NO EVENT SHALL THE COPYRIGHT OWNER OR CONTRIBUTORS BE LIABLE FOR ANY DIRECT, INDIRECT, INCIDENTAL, SPECIAL, EXEMPLARY, OR CONSEQUENTIAL DAMAGES (INCLUDING, BUT NOT LIMITED TO, PROCUREMENT OF SUBSTITUTE GOODS OR SERVICES; LOSS OF USE, DATA, OR PROFITS; OR BUSINESS INTERRUPTION) HOWEVER CAUSED AND ON ANY THEORY OF LIABILITY, WHETHER IN CONTRACT, STRICT LIABILITY, OR TORT (INCLUDING NEGLIGENCE OR OTHERWISE) ARISING IN ANY WAY OUT OF THE USE OF THIS SOFTWARE, EVEN IF ADVISED OF THE POSSIBILITY OF SUCH DAMAGE.

```
# (C) Copyright 2002-2006
# Wolfgang Denk, DENX Software Engineering, wd@denx.de.
#
# See file CREDITS for list of people who contributed to this
# project.
#
# This program is free software; you can redistribute it and/or
# modify it under the terms of the GNU General Public License as
# published by the Free Software Foundation; either version 2 of
# the License, or (at your option) any later version.
#
```

```
# This program is distributed in the hope that it will be useful,  
# but WITHOUT ANY WARRANTY; without even the implied warranty of  
# MERCHANTABILITY or FITNESS FOR A PARTICULAR PURPOSE. See the  
# GNU General Public License for more details.  
#  
# You should have received a copy of the GNU General Public License  
# along with this program; if not, write to the Free Software  
# Foundation, Inc., 59 Temple Place, Suite 330, Boston,  
# MA 02111-1307 USA  
#
```

***libroxml***

```
* This is the source file for lib libroxml.so  
* \author blunderer <blunderer@blunderer.org>  
* \date 23 Dec 2008  
*  
* Copyright (C) 2009 blunderer
```

LGPL v2.1

See full license text on page [357](#).

Copyright (C) 2010 blunderer

This library is free software; you can redistribute it and/or modify it under the terms of the GNU Lesser General Public License as published by the Free Software Foundation; either version 2.1 of the License, or (at your option) any later version. The author added a static linking exception, see License.txt.

This library is distributed in the hope that it will be useful, but WITHOUT ANY WARRANTY; without even the implied warranty of MERCHANTABILITY or FITNESS FOR A PARTICULAR PURPOSE. See the GNU Lesser General Public License for more details.

You should have received a copy of the GNU Lesser General Public License along with this library; if not, write to the Free Software Foundation, Inc., 51 Franklin Street, Fifth Floor, Boston, MA 02110-1301 USA



As a special exception to the LGPL v2.1 (below), the copyright holders of this library give you permission to statically link this library with independent modules to produce an executable, regardless of the license terms of these independent modules, and to copy and distribute the resulting executable under terms of your choice, provided that you also meet, for each linked independent module, the terms and conditions of the license of that module. The resulting executable may therefore be distributed without complying with the LGPL terms that state that recipients of your executable must be able to relink against modified versions of the library.

It is also appreciated if you mention in the README or CREDITS the use of this library.

An independent module is a module which is not derived from or based on this library. If you modify this library, you may extend this exception to your version of the library, but you are not obligated to do so. If you do not wish to do so, delete this exception statement from your version.

```
# (C) Copyright 2002-2006
# Wolfgang Denk, DENX Software Engineering, wd@denx.de.
#
# See file CREDITS for list of people who contributed to this
# project.
#
# This program is free software; you can redistribute it and/or
# modify it under the terms of the GNU General Public License as
# published by the Free Software Foundation; either version 2 of
# the License, or (at your option) any later version.
#
# This program is distributed in the hope that it will be useful,
# but WITHOUT ANY WARRANTY; without even the implied warranty of
# MERCHANTABILITY or FITNESS FOR A PARTICULAR PURPOSE. See the
# GNU General Public License for more details.
#
# You should have received a copy of the GNU General Public License
# along with this program; if not, write to the Free Software
# Foundation, Inc., 59 Temple Place, Suite 330, Boston,
# MA 02111-1307 USA
#
```

*contrack-tools*

```
/*
 * (C) 2006-2007 by Pablo Neira Ayuso <pablo@netfilter.org>
 *
 * This program is free software; you can redistribute it and/or modify
 * it under the terms of the GNU General Public License as published by
 * the Free Software Foundation; either version 2 of the License, or
 * (at your option) any later version.
 *
 * This program is distributed in the hope that it will be useful,
 * but WITHOUT ANY WARRANTY; without even the implied warranty of
 * MERCHANTABILITY or FITNESS FOR A PARTICULAR PURPOSE. See the
 * GNU General Public License for more details.
 *
 * You should have received a copy of the GNU General Public License
 * along with this program; if not, write to the Free Software
 * Foundation, Inc., 675 Mass Ave, Cambridge, MA 02139, USA.
 */

/*
Red Black Trees
(C) 1999 Andrea Arcangeli <andrea@suse.de>
(C) 2002 David Woodhouse <dwmw2@infradead.org>

This program is free software; you can redistribute it and/or modify
it under the terms of the GNU General Public License as published by
the Free Software Foundation; either version 2 of the License, or
(at your option) any later version.
```

This program is distributed in the hope that it will be useful,  
but WITHOUT ANY WARRANTY; without even the implied warranty of  
MERCHANTABILITY or FITNESS FOR A PARTICULAR PURPOSE. See the  
GNU General Public License for more details.

You should have received a copy of the GNU General Public License  
along with this program; if not, write to the Free Software  
Foundation, Inc., 59 Temple Place, Suite 330, Boston, MA 02111-1307 USA

linux/lib/rbtree.c

\*/

GPLv2

See full license text on page [335](#).

```
# (C) Copyright 2002-2006
# Wolfgang Denk, DENX Software Engineering, wd@denx.de.
#
# See file CREDITS for list of people who contributed to this
# project.
#
# This program is free software; you can redistribute it and/or
# modify it under the terms of the GNU General Public License as
# published by the Free Software Foundation; either version 2 of
# the License, or (at your option) any later version.
#
# This program is distributed in the hope that it will be useful,
# but WITHOUT ANY WARRANTY; without even the implied warranty of
# MERCHANTABILITY or FITNESS FOR A PARTICULAR PURPOSE. See the
# GNU General Public License for more details.
#
# You should have received a copy of the GNU General Public License
# along with this program; if not, write to the Free Software
# Foundation, Inc., 59 Temple Place, Suite 330, Boston,
# MA 02111-1307 USA
#
```

*libmnl*

```
/*
 * (C) 2008-2012 by Pablo Neira Ayuso <pablo@netfilter.org>
 *
 * This program is free software; you can redistribute it and/or modify
 * it under the terms of the GNU Lesser General Public License as published
 * by the Free Software Foundation; either version 2.1 of the License, or
 * (at your option) any later version.
 */
```

LGPL v2.1

See full license text on page [357](#).

```
# (C) Copyright 2002-2006
# Wolfgang Denk, DENX Software Engineering, wd@denx.de.
#
# See file CREDITS for list of people who contributed to this
# project.
#
# This program is free software; you can redistribute it and/or
# modify it under the terms of the GNU General Public License as
# published by the Free Software Foundation; either version 2 of
# the License, or (at your option) any later version.
#
# This program is distributed in the hope that it will be useful,
# but WITHOUT ANY WARRANTY; without even the implied warranty of
# MERCHANTABILITY or FITNESS FOR A PARTICULAR PURPOSE. See the
# GNU General Public License for more details.
#
# You should have received a copy of the GNU General Public License
# along with this program; if not, write to the Free Software
# Foundation, Inc., 59 Temple Place, Suite 330, Boston,
# MA 02111-1307 USA
#
```

*libnetfilter\_contrack*

```
/*
 * (C) 2005-2011 by Pablo Neira Ayuso <pablo@netfilter.org>
 *
 * This program is free software; you can redistribute it and/or modify it
 * under the terms of the GNU General Public License as published by
```

```
* the Free Software Foundation; either version 2 of the License, or
* (at your option) any later version.
*/

/*
* (C) 2005-2011 by Pablo Neira Ayuso <pablo@netfilter.org>
*      Harald Welte <laforge@netfilter.org>
*
* This program is free software; you can redistribute it and/or modify it
* under the terms of the GNU General Public License as published by
* the Free Software Foundation; either version 2 of the License, or
* (at your option) any later version.
*/
```

## GPLv2

See full license text on page [335](#).

```
# (C) Copyright 2002-2006
# Wolfgang Denk, DENX Software Engineering, wd@denx.de.
#
# See file CREDITS for list of people who contributed to this
# project.
#
# This program is free software; you can redistribute it and/or
# modify it under the terms of the GNU General Public License as
# published by the Free Software Foundation; either version 2 of
# the License, or (at your option) any later version.
#
# This program is distributed in the hope that it will be useful,
# but WITHOUT ANY WARRANTY; without even the implied warranty of
# MERCHANTABILITY or FITNESS FOR A PARTICULAR PURPOSE. See the
# GNU General Public License for more details.
#
# You should have received a copy of the GNU General Public License
# along with this program; if not, write to the Free Software
# Foundation, Inc., 59 Temple Place, Suite 330, Boston,
# MA 02111-1307 USA
#
```

*libnfnetlink*

```
/* iftable - table of network interfaces
*
* (C) 2004 by Astaro AG, written by Harald Welte <hwelte@astaro.com>
* (C) 2008 by Pablo Neira Ayuso <pablo@netfilter.org>
*
* This software is Free Software and licensed under GNU GPLv2+.
*/

/* libnfnetlink.c: generic library for communication with netfilter
*
* (C) 2002-2006 by Harald Welte <laforge@gnumonks.org>
* (C) 2006-2011 by Pablo Neira Ayuso <pablo@netfilter.org>
*
* Based on some original ideas from Jay Schulist <jschlst@samba.org>
*
* Development of this code funded by Astaro AG (http://www.astaro.com)
*
* This program is free software; you can redistribute it and/or modify it
* under the terms of the GNU General Public License version 2 as published
* by the Free Software Foundation.
*
* 2005-09-14 Pablo Neira Ayuso <pablo@netfilter.org>:
* Define structure nfnlhdr
* Added __be64_to_cpu function
* Use NFA_TYPE macro to get the attribute type
*
* 2006-01-14 Harald Welte <laforge@netfilter.org>:
* introduce nfnl_subsys_handle
```

```
*
* 2006-01-15 Pablo Neira Ayuso <pablo@netfilter.org>:
* set missing subsys_id in nfnl_subsys_open
* set missing nfnlh->local.nl_pid in nfnl_open
*
* 2006-01-26 Harald Welte <laforge@netfilter.org>:
* remove bogus nfnlh->local.nl_pid from nfnl_open ;)
* add 16bit attribute functions
*
* 2006-07-03 Pablo Neira Ayuso <pablo@netfilter.org>:
* add iterator API
* add replacements for nfnl_listen and nfnl_talk
* fix error handling
* add assertions
* add documentation
* minor cleanups
*/

/* rtnl - rtnetlink utility functions
*
* (C) 2004 by Astaro AG, written by Harald Welte <hwelte@astaro.com>
*
* Adapted to nfnetlink by Eric Leblond <eric@inl.fr>
*
* This software is free software and licensed under GNU GPLv2+.
*
*/
```

GPLv2

See full license text on page 335.

```
# (C) Copyright 2002-2006
# Wolfgang Denk, DENX Software Engineering, wd@denx.de.
#
# See file CREDITS for list of people who contributed to this
# project.
#
# This program is free software; you can redistribute it and/or
# modify it under the terms of the GNU General Public License as
# published by the Free Software Foundation; either version 2 of
# the License, or (at your option) any later version.
#
# This program is distributed in the hope that it will be useful,
# but WITHOUT ANY WARRANTY; without even the implied warranty of
# MERCHANTABILITY or FITNESS FOR A PARTICULAR PURPOSE. See the
# GNU General Public License for more details.
#
# You should have received a copy of the GNU General Public License
# along with this program; if not, write to the Free Software
# Foundation, Inc., 59 Temple Place, Suite 330, Boston,
# MA 02111-1307 USA
#
```

*lua-cjson*

Copyright (c) 2010-2012 Mark Pulford <mark@kyne.com.au>

Permission is hereby granted, free of charge, to any person obtaining a copy of this software and associated documentation files (the "Software"), to deal in the Software without restriction, including without limitation the rights to use, copy, modify, merge, publish, distribute, sublicense, and/or sell copies of the Software, and to permit persons to whom the Software is furnished to do so, subject to the following conditions:

The above copyright notice and this permission notice shall be included in all copies or substantial portions of the Software.

THE SOFTWARE IS PROVIDED "AS IS", WITHOUT WARRANTY OF ANY KIND, EXPRESS OR IMPLIED, INCLUDING BUT NOT LIMITED TO THE WARRANTIES OF MERCHANTABILITY, FITNESS FOR A PARTICULAR PURPOSE AND NONINFRINGEMENT. IN NO EVENT SHALL THE AUTHORS OR COPYRIGHT HOLDERS BE LIABLE FOR ANY CLAIM, DAMAGES OR OTHER LIABILITY, WHETHER IN AN ACTION OF CONTRACT, TORT OR OTHERWISE, ARISING FROM, OUT OF OR IN CONNECTION WITH THE SOFTWARE OR THE USE OR OTHER DEALINGS IN THE SOFTWARE.

/\*\*\*\*\*

\*



\* The author of this software is David M. Gay.

\*

\* Copyright (c) 1991, 2000, 2001 by Lucent Technologies.

\*

\* Permission to use, copy, modify, and distribute this software for any  
 \* purpose without fee is hereby granted, provided that this entire notice  
 \* is included in all copies of any software which is or includes a copy  
 \* or modification of this software and in all copies of the supporting  
 \* documentation for such software.

\*

\* THIS SOFTWARE IS BEING PROVIDED "AS IS", WITHOUT ANY EXPRESS OR  
 IMPLIED

\* WARRANTY. IN PARTICULAR, NEITHER THE AUTHOR NOR LUCENT MAKES ANY

\* REPRESENTATION OR WARRANTY OF ANY KIND CONCERNING THE  
 MERCHANTABILITY

\* OF THIS SOFTWARE OR ITS FITNESS FOR ANY PARTICULAR PURPOSE.

\*

\*\*\*\*\*/

The MIT License (MIT)

Permission is hereby granted, free of charge, to any person obtaining a copy of this software and associated documentation files (the "Software"), to deal in the Software without restriction, including without limitation the rights to use, copy, modify, merge, publish, distribute, sublicense, and/or sell copies of the Software, and to permit persons to whom the Software is furnished to do so, subject to the following conditions:

The above copyright notice and this permission notice shall be included in all copies or substantial portions of the Software.

THE SOFTWARE IS PROVIDED "AS IS", WITHOUT WARRANTY OF ANY KIND, EXPRESS OR IMPLIED, INCLUDING BUT NOT LIMITED TO THE WARRANTIES OF MERCHANTABILITY, FITNESS FOR A PARTICULAR PURPOSE AND NONINFRINGEMENT. IN NO EVENT SHALL THE AUTHORS OR COPYRIGHT HOLDERS

BE LIABLE FOR ANY CLAIM, DAMAGES OR OTHER LIABILITY, WHETHER IN AN ACTION OF CONTRACT, TORT OR OTHERWISE, ARISING FROM, OUT OF OR IN CONNECTION WITH THE SOFTWARE OR THE USE OR OTHER DEALINGS IN THE SOFTWARE.

```
# (C) Copyright 2002-2006
# Wolfgang Denk, DENX Software Engineering, wd@denx.de.
#
# See file CREDITS for list of people who contributed to this
# project.
#
# This program is free software; you can redistribute it and/or
# modify it under the terms of the GNU General Public License as
# published by the Free Software Foundation; either version 2 of
# the License, or (at your option) any later version.
#
# This program is distributed in the hope that it will be useful,
# but WITHOUT ANY WARRANTY; without even the implied warranty of
# MERCHANTABILITY or FITNESS FOR A PARTICULAR PURPOSE. See the
# GNU General Public License for more details.
#
# You should have received a copy of the GNU General Public License
# along with this program; if not, write to the Free Software
# Foundation, Inc., 59 Temple Place, Suite 330, Boston,
# MA 02111-1307 USA
#
```

**libubox**

GPLv2  
See full license text on page [335](#).

Copyright (C) 2010-2016 Felix Fietkau <nbd@openwrt.org>  
Permission to use, copy, modify, and/or distribute this software for any purpose with or without fee is hereby granted, provided that the above copyright notice and this permission notice appear in all copies.

THE SOFTWARE IS PROVIDED "AS IS" AND THE AUTHOR DISCLAIMS ALL WARRANTIES WITH REGARD TO THIS SOFTWARE INCLUDING ALL IMPLIED WARRANTIES OF MERCHANTABILITY AND FITNESS. IN NO EVENT SHALL THE AUTHOR BE LIABLE FOR ANY SPECIAL, DIRECT, INDIRECT, OR CONSEQUENTIAL DAMAGES OR ANY DAMAGES WHATSOEVER RESULTING FROM LOSS OF USE, DATA OR PROFITS, WHETHER IN AN ACTION OF CONTRACT, NEGLIGENCE OR OTHER TORTIOUS ACTION, ARISING OUT OF OR IN CONNECTION WITH THE USE OR PERFORMANCE OF THIS SOFTWARE.

```
# (C) Copyright 2002-2006
# Wolfgang Denk, DENX Software Engineering, wd@denx.de.
#
# See file CREDITS for list of people who contributed to this
# project.
#
# This program is free software; you can redistribute it and/or
# modify it under the terms of the GNU General Public License as
# published by the Free Software Foundation; either version 2 of
# the License, or (at your option) any later version.
#
```

```
# This program is distributed in the hope that it will be useful,  
# but WITHOUT ANY WARRANTY; without even the implied warranty of  
# MERCHANTABILITY or FITNESS FOR A PARTICULAR PURPOSE. See the  
# GNU General Public License for more details.  
#  
# You should have received a copy of the GNU General Public License  
# along with this program; if not, write to the Free Software  
# Foundation, Inc., 59 Temple Place, Suite 330, Boston,  
# MA 02111-1307 USA  
#
```

---

**MAC-telnet**

GPLv2

See full license text on page [335](#).

Mac-Telnet - Connect to RouterOS or mactelnetd devices via MAC address  
Copyright (C) 2010, Håkon Nessjøen <haakon.nessjoen@gmail.com>

This program is free software; you can redistribute it and/or modify  
it under the terms of the GNU General Public License as published by  
the Free Software Foundation; either version 2 of the License, or  
(at your option) any later version.

This program is distributed in the hope that it will be useful,  
but WITHOUT ANY WARRANTY; without even the implied warranty of  
MERCHANTABILITY or FITNESS FOR A PARTICULAR PURPOSE. See the  
GNU General Public License for more details.

You should have received a copy of the GNU General Public License along  
with this program; if not, write to the Free Software Foundation, Inc.,  
51 Franklin Street, Fifth Floor, Boston, MA 02110-1301 USA.

```
# (C) Copyright 2002-2006  
# Wolfgang Denk, DENX Software Engineering, wd@denx.de.  
#
```

```
# See file CREDITS for list of people who contributed to this  
# project.  
#
```

```
# This program is free software; you can redistribute it and/or  
# modify it under the terms of the GNU General Public License as  
# published by the Free Software Foundation; either version 2 of  
# the License, or (at your option) any later version.  
#
```

```
# This program is distributed in the hope that it will be useful,  
# but WITHOUT ANY WARRANTY; without even the implied warranty of  
# MERCHANTABILITY or FITNESS FOR A PARTICULAR PURPOSE. See the  
# GNU General Public License for more details.  
#
```

```
# You should have received a copy of the GNU General Public License  
# along with this program; if not, write to the Free Software  
# Foundation, Inc., 59 Temple Place, Suite 330, Boston,  
# MA 02111-1307 USA  
#
```

**ARP-NAT**

```
#####
# Client bridge hotplug script (/etc/hotplug.d/net/20-client_bridge)
# Copyright Eric Bishop, 2009 eric@gargoyle-router.com
# Created for Gargoyle, www.gargoyle-router.com
#
#This is free software licensed under the terms of the GNU GPL v2.0
#
# You must have the arpnat ebttables module for this to work
#####
/*
 * ebt_arpnat
 *
 * Authors:
 *   Kestutis Barkauskas <gpl@wilibox.com>
 *
 * November, 2005
 *
 * Rewritten by:
 *   Kestutis Barkauskas and Kestutis Kupciunas <gpl@ubnt.com>
 *
 * June, 2010
 *
 * Updated to work with more recent kernel versions (e.g., 2.6.30)
 * Ditched entry expiration in favor of wiping entries with duplicate ips, when situation
arises
 * Fixed arpnat procfs (though both arpnat_cache and arpnat_info are both in root
procfs directory now)
 *
 * Eric Bishop <eric@gargoyle-router.com>
 *
 * ebt_arpnat
 *
 * Authors:
 *   Kestutis Barkauskas <gpl@wilibox.com>
 *
 * November, 2005
 *
 * Rewritten by:
 *   Kestutis Barkauskas and Kestutis Kupciunas <gpl@ubnt.com>
 *
 * June, 2010
 *
 * Updated to work with more recent kernel versions (e.g., 2.6.30)
 * Ditched entry expiration in favor of wiping entries with duplicate ips, when situation
arises
 * Fixed arpnat procfs (though both arpnat_cache and arpnat_info are both in root
procfs directory now)
 *
 * Eric Bishop <eric@gargoyle-router.com>
 */

GPLv2
```

	<p>See full license text on page <a href="#">335</a>.</p> <pre># (C) Copyright 2002-2006 # Wolfgang Denk, DENX Software Engineering, wd@denx.de. # # See file CREDITS for list of people who contributed to this # project. # # This program is free software; you can redistribute it and/or # modify it under the terms of the GNU General Public License as # published by the Free Software Foundation; either version 2 of # the License, or (at your option) any later version. # # This program is distributed in the hope that it will be useful, # but WITHOUT ANY WARRANTY; without even the implied warranty of # MERCHANTABILITY or FITNESS FOR A PARTICULAR PURPOSE. See the # GNU General Public License for more details. # # You should have received a copy of the GNU General Public License # along with this program; if not, write to the Free Software # Foundation, Inc., 59 Temple Place, Suite 330, Boston, # MA 02111-1307 USA #</pre>
<b><i>odhcp6c</i></b>	<pre>/**  * Copyright (C) 2012-2014 Steven Barth steven@midlink.org&gt;  *  * This program is free software; you can redistribute it and/or modify  * it under the terms of the GNU General Public License v2 as published by  * the Free Software Foundation.  *  * This program is distributed in the hope that it will be useful,  * but WITHOUT ANY WARRANTY; without even the implied warranty of  * MERCHANTABILITY or FITNESS FOR A PARTICULAR PURPOSE. See the  * GNU General Public License for more details.  */</pre>
<b><i>memtester</i></b>	<p>GPLv2</p> <p>See full license text on page <a href="#">335</a>.</p> <pre>/*  * memtester version 4  *  * Very simple but very effective user-space memory tester.  * Originally by Simon Kirby &lt;sim@stormix.com&gt; &lt;sim@neato.org&gt;  * Version 2 by Charles Cazabon &lt;charlesc-memtester@pyropus.ca&gt;  * Version 3 not publicly released.  * Version 4 rewrite:  * Copyright (C) 2004-2010 Charles Cazabon &lt;charlesc-memtester@pyropus.ca&gt;  * Licensed under the terms of the GNU General Public License version 2 (only).  * See the file COPYING for details.</pre>

	<p>* */</p>
<p><b>libpam</b></p>	<p>Unless otherwise <i>*explicitly*</i> stated the following text describes the licensed conditions under which the contents of this Linux-PAM release may be distributed:</p> <p>-----</p> <p>Redistribution and use in source and binary forms of Linux-PAM, with or without modification, are permitted provided that the following conditions are met:</p> <ol style="list-style-type: none"> <li>1. Redistributions of source code must retain any existing copyright notice, and this entire permission notice in its entirety, including the disclaimer of warranties.</li> <li>2. Redistributions in binary form must reproduce all prior and current copyright notices, this list of conditions, and the following disclaimer in the documentation and/or other materials provided with the distribution.</li> <li>3. The name of any author may not be used to endorse or promote products derived from this software without their specific prior written permission.</li> </ol> <p>ALTERNATIVELY, this product may be distributed under the terms of the GNU General Public License, in which case the provisions of the GNU GPL are required INSTEAD OF the above restrictions. (This clause is necessary due to a potential conflict between the GNU GPL and the restrictions contained in a BSD-style copyright.)</p> <p>THIS SOFTWARE IS PROVIDED "AS IS" AND ANY EXPRESS OR IMPLIED WARRANTIES, INCLUDING, BUT NOT LIMITED TO, THE IMPLIED WARRANTIES OF MERCHANTABILITY AND FITNESS FOR A PARTICULAR PURPOSE ARE DISCLAIMED. IN NO EVENT SHALL THE AUTHOR(S) BE LIABLE FOR ANY DIRECT, INDIRECT, INCIDENTAL, SPECIAL, EXEMPLARY, OR CONSEQUENTIAL DAMAGES (INCLUDING, BUT NOT LIMITED TO, PROCUREMENT OF SUBSTITUTE GOODS OR SERVICES; LOSS OF USE, DATA, OR PROFITS; OR BUSINESS INTERRUPTION) HOWEVER CAUSED AND ON ANY THEORY OF LIABILITY, WHETHER IN CONTRACT, STRICT LIABILITY, OR TORT (INCLUDING NEGLIGENCE OR OTHERWISE) ARISING IN ANY WAY OUT OF THE USE OF THIS SOFTWARE, EVEN IF ADVISED OF THE POSSIBILITY OF SUCH DAMAGE.</p> <p>-----</p>
<p><b>lldpd</b></p>	<p>lldpd is distributed under the ISC license:</p> <ul style="list-style-type: none"> <li>&gt; Permission to use, copy, modify, and/or distribute this software for any</li> <li>&gt; purpose with or without fee is hereby granted, provided that the above</li> <li>&gt; copyright notice and this permission notice appear in all copies.</li> <li>&gt;</li> <li>&gt; THE SOFTWARE IS PROVIDED "AS IS" AND THE AUTHOR DISCLAIMS ALL WARRANTIES</li> <li>&gt; WITH REGARD TO THIS SOFTWARE INCLUDING ALL IMPLIED WARRANTIES OF</li> <li>&gt; MERCHANTABILITY AND FITNESS. IN NO EVENT SHALL THE AUTHOR BE LIABLE FOR</li> <li>&gt; ANY SPECIAL, DIRECT, INDIRECT, OR CONSEQUENTIAL DAMAGES OR ANY DAMAGES</li> <li>&gt; WHATSOEVER RESULTING FROM LOSS OF USE, DATA OR PROFITS, WHETHER IN AN</li> </ul>

> ACTION OF CONTRACT, NEGLIGENCE OR OTHER TORTIOUS ACTION, ARISING OUT OF  
> OR IN CONNECTION WITH THE USE OR PERFORMANCE OF THIS SOFTWARE.

Also, `lldpcli` will be linked to GNU Readline (which is GPL licensed)  
if available. To avoid this, use `--without-readline` as a configure  
option.

Copyright (c) 2008 Vincent Bernat <bernat@luffy.cx>

\*

\* Permission to use, copy, modify, and/or distribute this software for any  
\* purpose with or without fee is hereby granted, provided that the above  
\* copyright notice and this permission notice appear in all copies.

\*

\* THE SOFTWARE IS PROVIDED "AS IS" AND THE AUTHOR DISCLAIMS ALL WARRANTIES  
\* WITH REGARD TO THIS SOFTWARE INCLUDING ALL IMPLIED WARRANTIES OF  
\* MERCHANTABILITY AND FITNESS. IN NO EVENT SHALL THE AUTHOR BE LIABLE FOR  
\* ANY SPECIAL, DIRECT, INDIRECT, OR CONSEQUENTIAL DAMAGES OR ANY DAMAGES  
\* WHATSOEVER RESULTING FROM LOSS OF USE, DATA OR PROFITS, WHETHER IN AN  
\* ACTION OF CONTRACT, NEGLIGENCE OR OTHER TORTIOUS ACTION, ARISING OUT OF  
\* OR IN CONNECTION WITH THE USE OR PERFORMANCE OF THIS SOFTWARE.

\*/

---

***util-linux***

GPLv2

See full license text on page [335](#).

LGPLv2

See full license text on page [357](#).

BSD

See full license text on page [381](#).

Public Domain

## Hardware warranty

Cambium's standard hardware warranty is for one (1) year from date of shipment from Cambium Networks or a Cambium Point-To-Multipoint Distributor. Cambium Networks warrants that hardware will conform to the relevant published specifications and will be free from material defects in material and workmanship under normal use and service. Cambium Networks shall within this time, at its own option, either repair or replace the defective product within thirty (30) days of receipt of the defective product. Repaired or replaced product will be subject to the original warranty period but not less than thirty (30) days.



**Limit of liability**

IN NO EVENT SHALL CAMBIUM NETWORKS BE LIABLE TO YOU OR ANY OTHER PARTY FOR ANY DIRECT, INDIRECT, GENERAL, SPECIAL, INCIDENTAL, CONSEQUENTIAL, EXEMPLARY OR OTHER DAMAGE ARISING OUT OF THE USE OR INABILITY TO USE THE PRODUCT (INCLUDING, WITHOUT LIMITATION, DAMAGES FOR LOSS OF BUSINESS PROFITS, BUSINESS INTERRUPTION, LOSS OF BUSINESS INFORMATION OR ANY OTHER PECUNIARY LOSS, OR FROM ANY BREACH OF WARRANTY, EVEN IF CAMBIUM NETWORKS HAS BEEN ADVISED OF THE POSSIBILITY OF SUCH DAMAGES. (Some states do not allow the exclusion or limitation of incidental or consequential damages, so the above exclusion or limitation may not apply to you.) IN NO CASE SHALL CAMBIUM'S LIABILITY EXCEED THE AMOUNT YOU PAID FOR THE PRODUCT.

**System threshold, output power and link loss**

For up-to-date data, please refer to the **ePMP Capacity Planner Tool** available at <https://support.cambiumnetworks.com/files/epmp/>

## Dynamic transmitter output power

The ePMP system uses dynamic Tx power based on the current modulation at which it is operating to avoid EVM (Error Vector Magnitude) limitation ensuring optimal operation of the system. The following table specifies the system transmitter output power (dBm) per band and modulation mode:

**Table 141** Max Tx power (dBm) per band and modulation

Modulation Mode	2412-2472 MHz	2570-2620 MHz	4920-4990 MHz	4990-5080 MHz	5080-5150 MHz	5150-5480 MHz	5460-5725 MHz	5725-5980 MHz
MCS0	30	30	15	19	27	27	30	30
MCS1	30	30	15	19	27	27	30	30
MCS2	29	29	15	19	27	27	29	30
MCS3	29	29	13	17	26	26	27	30
MCS4	28	28	11	15	24	24	25	30
MCS5	28	28	11	15	22	22	23	27
MCS6	27	26	10	14	20	20	21	25
MCS7	27	25	8	12	19	18	19	23
MCS8	30	30	15	19	27	27	30	30
MCS9	30	30	15	19	27	27	30	30
MCS10	29	29	15	19	27	27	29	30
MCS11	29	29	13	17	26	26	27	30
MCS12	28	28	11	15	24	24	25	30
MCS13	28	28	11	15	22	22	23	27
MCS14	27	26	10	14	20	20	21	25
MCS15	27	25	8	12	18	18	19	23

- 
-

## Compliance with safety standards

This section lists the safety specifications against which the ePMP has been tested and certified. It also describes how to keep RF exposure within safe limits.

### ELECTRICAL SAFETY COMPLIANCE

The ePMP hardware has been tested for compliance to the electrical safety specifications listed in [Table 139](#).

**Table 142** ePMP safety compliance specifications

Region	Standard
USA	UL 60950-1, 2 <sup>nd</sup> Edition
Canada	CSA C22.2 No.60950 2 <sup>nd</sup> Edition
International	International CB certified and certified to IEC 60950-1:2005 (modified) plus EN60950-1:2006 + A1:2010

### ELECTROMAGNETIC COMPATIBILITY (EMC) COMPLIANCE

The ePMP complies with European EMC Specification EN301 489-1 with testing carried out to the detailed requirements of EN301 489-4.

The EMC specification type approvals that have been granted for ePMP are listed under [Table 140](#).

**Table 143** EMC emissions compliance

Region	Specification (Type Approvals)
USA	FCC CFR 47 Part 15 class B
Canada	RSS210, Issue 8 RSS247, Issue 2 (Feb 2017)
Europe	ETSI EN301 489-4

### HUMAN EXPOSURE TO RADIO FREQUENCY ENERGY

#### Standards

Relevant standards (USA and EC) applicable when working with RF equipment are:

- ANSI IEEE C95.1-1991, IEEE Standard for Safety Levels with Respect to Human Exposure to Radio Frequency Electromagnetic Fields, 3 kHz to 300 GHz.
- Council recommendation of 12 July 1999 on the limitation of exposure of the general public to electromagnetic fields (0 Hz to 300 GHz) (1999/519/EC) and respective national regulations.
- *Directive 2004/40/EC of the European Parliament and of the Council of 29 April 2004 on the minimum health and safety requirements regarding the exposure of workers to the risks arising from physical agents (electromagnetic fields) (18th individual Directive within the meaning of Article 16(1) of Directive 89/391/EEC).*

- US FCC limits for the general population. See the FCC web site <http://www.fcc.gov> and the policies, guidelines, and requirements in Part 1 of Title 47 of the Code of Federal Regulations, as well as the guidelines and suggestions for evaluating compliance in FCC OET Bulletin 65.
- Health Canada limits for the general population. See the Health Canada web site [http://www.hc-sc.gc.ca/ewh-semt/pubs/radiation/99ehd-dhm237/limits-limités\\_e.html](http://www.hc-sc.gc.ca/ewh-semt/pubs/radiation/99ehd-dhm237/limits-limités_e.html) and Safety Code 6.
- EN 50383:2016 Basic standard for the calculation and measurement of electromagnetic field strength and SAR related to human exposure from radio base Subscriber Modules and fixed terminal Subscriber Modules for wireless telecommunication systems (110 MHz - 40 GHz).
- BS EN 50385:2017 Product standard to demonstrate the compliances of radio base Subscriber Modules and fixed terminal Subscriber Modules for wireless telecommunication systems with the basic restrictions or the reference levels related to human exposure to radio frequency electromagnetic fields (110 MHz – 40 GHz) – general public.
- ICNIRP (International Commission on Non-Ionizing Radiation Protection) guidelines for the general public. See the ICNIRP web site <http://www.icnirp.de/> and Guidelines for Limiting Exposure to Time-Varying Electric, Magnetic, and Electromagnetic Fields.

### ***Power density exposure limit***

Install the radios for the ePMP family of PMP wireless solutions so as to provide and maintain the minimum separation distances from all persons.

The applicable power density exposure limit from the standards (see [Human exposure to radio frequency energy](#) on page [428](#)) is:

- **10 W/m<sup>2</sup>** for RF energy in the 5 GHz and 2.4 GHz frequency bands.

### Calculation of power density

Peak power density in the far field of a radio frequency point source is calculated as follows:



Note

The following calculation is based on the ANSI IEEE C95.1-1991 method, as that provides a worst case analysis. Details of the assessment to EN50383:2002 can be provided, if required.

$$S = \frac{P \cdot G}{4\pi d^2}$$

Where:

Is:

S	power density in W/m <sup>2</sup>
P	maximum average transmit power capability of the radio, in W
G	total Tx gain as a factor, converted from dB
d	distance from point source, in m

Rearranging terms to solve for distance yields:

$$d = \sqrt{\frac{P \cdot G}{4\pi \cdot S}}$$

### Calculated distances and power compliance margins

The calculated minimum separation distances, recommended distances and resulting margins for each frequency band and antenna combination is shown in [Table 141](#) through [Table 165](#). These are conservative distances that include compliance margins. At these and greater separation distances, the power density from the RF field is below generally accepted limits for the general population.

Explanation of terms used [Table 141](#) through [Table 165](#):

Tx burst – maximum average transmit power in burst (Watt)

P – maximum average transmit power capability of the radio (Watt)

G – total transmit gain as a factor, converted from dB

S – power density (W/m<sup>2</sup>)

d – minimum distance from point source (meters)

R – recommended distances (meters)

C – compliance factor

**Table 141** and **Table 144** below list the power compliance margins for the following ePMP 2000 devices:

Model Number	Part Number	FCC ID	Industry Canada
C058900P132A	C058900A132A	Z8H89FT0020	109W-0020
	C058900L132A		

**Table 144** ePMP 2000 Power compliance margins, 5.1 GHz, AP

Conn Type	Channel Bandwidth	Antenna	P (W)	G	S (W/m <sup>2</sup> )	d (m)	R (m)	C
PMP								
PTP	5 MHz	Connectorized Antenna, 17 dBi	0.02	50	9.011	0.10	0.3	-
PMP								
PTP	40 MHz	Connectorized Antenna, 17 dBi	0.01	50	9.011	0.07	0.3	-

**Table 145** ePMP 2000 Power compliance margins, 5.2 GHz, AP

Conn Type	Channel Bandwidth	Antenna	P (W)	G	S (W/m <sup>2</sup> )	d (m)	R (m)	C
PMP								
PTP	5 MHz	Connectorized Antenna, 17 dBi	0.017	50	9.13	0.09	0.3	-
PMP								
PTP	40 MHz	Connectorized Antenna, 17 dBi	0.014	50	9.13	0.08	0.3	-

**Table 146** ePMP 2000 Power compliance margins, 5.4 GHz, AP

Conn Type	Channel Bandwidth	Antenna	P (W)	G	S (W/m <sup>2</sup> )	d (m)	R (m)	C
PMP								
PTP	5 MHz	Connectorized Antenna, 17 dBi	0.018	50	9.39	0.09	0.3	-
PMP								
PTP	40 MHz	Connectorized Antenna, 17 dBi	0.017	50	9.39	0.09	0.3	-

**Table 147** ePMP 2000 Power compliance margins, 5.8 GHz, AP

Conn Type	Channel Bandwidth	Antenna	P (W)	G	S (W/m <sup>2</sup> )	d (m)	R (m)	C
PMP								
PTP	5 MHz	Connectorized Antenna, 17 dBi	0.069	50	9.011	0.17	0.3	-
PMP								
PTP	40 MHz	Connectorized Antenna, 17 dBi	0.07	50	9.011	0.08	0.3	-

Table 145 to Table 148 below are the power compliance margins for the following ePMP 1000 devices:

Model Number	Part Number	FCC ID	Industry Canada
C058900P112A	C058900C112A	Z8H89FT0006	109W-0006

**Table 148** ePMP 1000 Power compliance margins, 5.1 GHz, AP

Conn Type	Channel Bandwidth	Antenna	P (W)	G	S (W/m <sup>2</sup> )	d (m)	R (m)	C
PMP	5/10 MHz	Connectorized Omni, 3 dBi	0.063	2.0	9.011	0.03	0.1	99.8
PMP	5/10 MHz	Connectorized Sector Array, 16 dBi	0.032	39.8	9.011	0.10	0.3	89.8
PTP	5/10 MHz	Connectorized Patch Panel Array, 23 dBi	0.010	199.5	9.011	0.13	0.3	56.7
PTP	5/10 MHz	Connectorized Dish, 30 dBi	0.002	1000.0	9.011	0.13	0.3	56.7
PMP	20/40 MHz	Connectorized Omni, 3 dBi	0.063	2.0	9.011	0.03	0.1	99.8
PMP	20/40 MHz	Connectorized Sector Array, 16 dBi	0.100	39.8	9.011	0.19	0.4	45.5
PTP	20/40 MHz	Connectorized Patch Panel Array, 23 dBi	0.008	199.5	9.011	0.12	0.3	64.3
PTP	20/40 MHz	Connectorized Dish, 30 dBi	0.001	1000.0	9.011	0.11	0.3	80.9



**Table 149** ePMP 1000 Power compliance margins, 5.2 GHz, AP

Conn Type	Channel Bandwidth	Antenna	P (W)	G	S (W/m <sup>2</sup> )	d (m)	R (m)	C
PMP	5/10 MHz	Connectorized Omni, 3 dBi	0.063	2.0	9.130	0.03	0.1	91.1
PMP	5/10 MHz	Connectorized Sector Array, 16 dBi	0.032	39.8	9.130	0.10	0.3	82.0
PTP	5/10 MHz	Connectorized Patch Panel Array, 23 dBi	0.010	199.5	9.130	0.13	0.3	51.7
PTP	5/10 MHz	Connectorized Dish, 30 dBi	0.002	1000.0	9.130	0.13	0.3	51.7
PMP	20/40 MHz	Connectorized Omni, 3 dBi	0.063	2.0	9.130	0.03	0.1	91.1
PMP	20/40 MHz	Connectorized Sector Array, 16 dBi	0.100	39.8	9.130	0.19	0.4	46.1
PTP	20/40 MHz	Connectorized Patch Panel Array, 23 dBi	0.008	199.5	9.130	0.12	0.3	65.1
PTP	20/40 MHz	Connectorized Dish, 30 dBi	0.001	1000.0	9.130	0.10	0.3	82.0

**Table 150** ePMP 1000 Power compliance margins, 5.4 GHz, AP

Conn Type	Channel Bandwidth	Antenna	P (W)	G	S (W/m <sup>2</sup> )	d (m)	R (m)	C
PMP	5/10 MHz	Connectorized Omni, 3 dBi	0.063	2.0	9.390	0.03	0.1	93.7
PMP	5/10 MHz	Connectorized Sector Array, 16 dBi	0.032	39.8	9.390	0.10	0.3	84.3
PTP	5/10 MHz	Connectorized Patch Panel Array, 23 dBi	0.010	199.5	9.390	0.13	0.3	53.2
PTP	5/10 MHz	Connectorized Dish, 30 dBi	0.002	1000.0	9.390	0.13	0.3	53.2
PMP	20/40 MHz	Connectorized Omni, 3 dBi	0.063	2.0	9.390	0.03	0.1	93.7
PMP	20/40 MHz	Connectorized Sector Array, 16 dBi	0.100	39.8	9.390	0.18	0.4	47.4
PTP	20/40 MHz	Connectorized Patch Panel Array, 23 dBi	0.008	199.5	9.390	0.12	0.3	67.0
PTP	20/40 MHz	Connectorized Dish, 30 dBi	0.001	1000.0	9.390	0.10	0.3	84.3

**Table 151** ePMP 1000 Power compliance margins, 5.8 GHz, AP

Conn Type	Channel Bandwidth	Antenna	P (W)	G	S (W/m <sup>2</sup> )	d (m)	R (m)	C
PMP	5/10 MHz	Connectorized Omni, 3 dBi	0.063	2.0	9.687	0.03	0.1	96.6
PMP	5/10 MHz	Connectorized Sector Array, 16 dBi	0.032	39.8	9.687	0.10	0.3	87.0
PTP	5/10 MHz	Connectorized Patch Panel Array, 23 dBi	0.010	199.5	9.687	0.13	0.3	54.9
PTP	5/10 MHz	Connectorized Dish, 30 dBi	0.002	1000.0	9.687	0.13	0.3	54.9
PMP	20/40 MHz	Connectorized Omni, 3 dBi	0.063	2.0	9.687	0.03	0.1	96.6
PMP	20/40 MHz	Connectorized Sector Array, 16 dBi	0.100	39.8	9.687	0.18	0.4	48.9
PTP	20/40 MHz	Connectorized Patch Panel Array, 23 dBi	0.008	199.5	9.687	0.11	0.3	69.1
PTP	20/40 MHz	Connectorized Dish, 30 dBi	0.001	1000.0	9.687	0.10	0.3	87.0

Table 149 through Table 153 below are the power compliance margins for the following devices:

Model Number	Part Number	FCC ID	Industry Canada
C058900P122A	C058900C122A	Z8H89FT0005	109W-0005

**Table 152** ePMP 1000 Power compliance margins, 5.1 GHz, SM

Conn Type	Channel Bandwidth	Antenna	P (W)	G	S (W/m <sup>2</sup> )	d (m)	R (m)	C
PMP	5/10 MHz	Connectorized Omni, 3 dBi	0.063	2.0	9.011	0.03	0.1	89.9
PMP	5/10 MHz	Integrated Patch Array, 16 dBi	0.100	39.8	9.011	0.19	0.4	45.5
PMP	5/10 MHz	Connectorized Sector Array, 16 dBi	0.100	39.8	9.011	0.19	0.4	45.5
PTP	5/10 MHz	Integrated Patch Array, 16 dBi	0.100	39.8	9.011	0.19	0.4	45.5
PTP	5/10 MHz	Connectorized Patch Panel Array, 23 dBi	0.013	199.5	9.011	0.15	0.3	40.6
PTP	5/10 MHz	Connectorized Dish, 30 dBi	0.001	1000.0	9.011	0.09	0.2	45.3
PMP	20/40 MHz	Connectorized Omni, 3 dBi	0.063	2.0	9.011	0.03	0.1	89.9
PMP	20/40 MHz	Integrated Patch Array, 16 dBi	0.032	39.8	9.011	0.11	0.2	36.0
PMP	20/40 MHz	Connectorized Sector Array, 16 dBi	0.032	39.8	9.011	0.11	0.3	80.9
PTP	20/40 MHz	Integrated Patch Array, 16 dBi	0.032	39.8	9.011	0.11	0.2	36.0
PTP	20/40 MHz	Connectorized Patch Panel Array, 23 dBi	0.005	199.5	9.011	0.09	0.2	45.3
PTP	20/40 MHz	Connectorized Dish, 30 dBi	0.001	1000.0	9.011	0.09	0.2	45.3



Caution

For countries that follow FCC regulations, the combined conducted power must be reduced according to Table 150, for the lower edge of the 5.1 GHz band in order, to meet restricted band requirements.

**Table 153** FCC conducted power (combined) for lower edge of 5.1 GHz

Channel Bandwidth	Antenna	Conducted Power (combined)
5/10 MHz	Connectorized Omni, 3 dBi	18 dBm
5/10 MHz	Integrated Patch Array, 16 dBi	7 dBm
5/10 MHz	Connectorized Sector Array, 16 dBi	7 dBm
5/10 MHz	Connectorized Patch Panel Array, 23 dBi	0 dBm
5/10 MHz	Connectorized Dish, 30 dBi	-7 dBm
20/40 MHz	Connectorized Omni, 3 dBi	15 dBm
20/40 MHz	Integrated Patch Array, 16 dBi	7 dBm
20/40 MHz	Connectorized Sector Array, 16 dBi	7 dBm
20/40 MHz	Connectorized Patch Panel Array, 23 dBi	2 dBm
20/40 MHz	Connectorized Dish, 30 dBi	-5 dBm

**Table 154** ePMP 1000 Power compliance margins, 5.2 GHz, SM

Antenna	P (W)	G	S (W/m <sup>2</sup> )	d (m)	R (m)	C
Integrated Patch Array, 13 dBi	0.020	20.0	9.130	0.06	0.2	115.2
Integrated Patch Array, 13 dBi with Reflector Dish, 6 dBi	0.020	79.4	9.130	0.12	0.3	65.1
Connectorized Patch Panel Array, 23 dBi	0.020	199.5	9.130	0.19	0.4	46.1
Connectorized Dish, 30 dBi	0.020	1000	9.130	0.42	1	57.5

**Table 155** ePMP 1000 Power compliance margins, 5.4 GHz, SM

Antenna	P (W)	G	S (W/m <sup>2</sup> )	d (m)	R (m)	C
Integrated Patch Array, 13 dBi	0.020	20.0	9.390	0.06	0.2	118.5
Integrated Patch Array, 13 dBi with Reflector Dish, 6 dBi	0.020	79.4	9.390	0.12	0.3	67.0
Connectorized Patch Panel Array, 23 dBi	0.020	199.5	9.390	0.18	0.4	47.4
Connectorized Dish, 30 dBi	0.020	1000	9.390	0.41	1	59.1

**Table 156** ePMP 1000 Power compliance margins, 5.8/5.9 GHz, SM

Antenna	P (W)	G	S (W/m <sup>2</sup> )	d (m)	R (m)	C
Integrated Patch Array, 13 dBi	0.200	20.0	9.687	0.18	0.4	48.9
Integrated Patch Array, 13 dBi with Reflector Dish, 6 dBi	0.200	79.4	9.687	0.36	0.8	49.1
Connectorized Patch Panel Array, 23 dBi	0.200	199.5	9.687	0.57	1.2	44.0
Connectorized Dish, 30 dBi	0.200	1000	9.687	1.28	2.5	38.1

**Table 157** ePMP 1000 Power compliance margins, 2.4 GHz, AP (FCC ID: Z8H89FT0012)

Conn Type	Channel Bandwidth	Antenna	P (W)	G	S (W/m <sup>2</sup> )	d (m)	R (m)	C
PMP	20 MHz	Connectorized, 8 dBi Omni	0.631	6.3	5.348	0.24	0.5	42.2
PMP	40 MHz	Connectorized, 8 dBi Omni	0.100	6.3	5.348	0.10	0.2	42.6
PMP	20 MHz	Connectorized, 17 dBi Sector	0.079	50.1	5.348	0.24	0.5	42.2
PMP	40 MHz	Connectorized, 17 dBi Sector	0.025	50.1	5.348	0.14	0.3	48.0
PTP	20 MHz	Connectorized, 25 dBi Dish	0.010	316.2	5.348	0.22	0.5	53.1
PTP	40 MHz	Connectorized, 25 dBi Dish	0.006	316.2	5.348	0.17	0.4	53.9

**Table 158** ePMP 1000 Power compliance margins, 2.4 GHz, SM (FCC ID: Z8H89FT0011)

Conn Type	Channel Bandwidth	Antenna	P (W)	G	S (W/m <sup>2</sup> )	d (m)	R (m)	C
PMP	20 MHz	Connectorized, 8 dBi Omni	0.631	6.3	5.348	0.24	0.5	42.2
PMP	20 MHz	Integrated, 12 dBi Patch	0.251	15.8	5.348	0.24	0.5	42.2
PMP	20 MHz	Integrated 12 dBi Patch with 8 dBi Reflector Dish	0.398	100.0	5.348	0.77	1.5	38.0
PMP	20 MHz	Connectorized, 17 dBi Sector	0.079	50.1	5.348	0.24	0.5	42.2
PMP	20 MHz	Connectorized, 19 dBi Panel	0.050	79.4	5.348	0.24	0.5	42.2
PMP	20 MHz	Connectorized, 25 dBi Dish	0.010	316.2	5.348	0.22	0.5	53.1
PMP	40 MHz	Connectorized, 8 dBi Omni	0.100	6.3	5.348	0.10	0.2	42.6
PMP	40 MHz	Integrated, 12 dBi Patch	0.050	15.8	5.348	0.11	0.3	76.1

PMP	40 MHz	Integrated 12 dBi Patch with 8 dBi Reflector Dish	0.050	100.0	5.348	0.27	0.6	48.2
PMP	40 MHz	Connectorized, 17 dBi Sector	0.025	50.1	5.348	0.14	0.3	48.0
PMP	40 MHz	Connectorized, 19 dBi Panel	0.020	79.4	5.348	0.15	0.3	38.1
PMP	40 MHz	Connectorized, 25 dBi Dish	0.006	316.2	5.348	0.17	0.4	53.9
PTP	20 MHz	Integrated, 12 dBi Patch	0.398	15.8	5.348	0.31	0.7	52.2
PTP	20 MHz	Integrated 12 dBi Patch with 8 dBi Reflector Dish	0.398	100.0	5.348	0.77	1.5	38.0
PTP	20 MHz	Connectorized, 17 dBi Sector	0.158	50.1	5.348	0.34	0.8	54.1
PTP	20 MHz	Connectorized, 19 dBi Panel	0.050	79.4	5.348	0.24	0.5	42.2
PTP	20 MHz	Connectorized, 25 dBi Dish	0.010	316.2	5.348	0.22	0.5	53.1
PTP	40 MHz	Integrated, 12 dBi Patch	0.050	15.8	5.348	0.11	0.3	76.1
PTP	40 MHz	Integrated 12 dBi Patch with 8 dBi Reflector Dish	0.050	100.0	5.348	0.27	0.6	48.2
PTP	40 MHz	Connectorized, 17 dBi Sector	0.025	50.1	5.348	0.14	0.3	48.0
PTP	40 MHz	Connectorized, 19 dBi Panel	0.020	79.4	5.348	0.15	0.4	67.8
PTP	40 MHz	Connectorized, 25 dBi Dish	0.006	316.2	5.348	0.17	0.4	53.9



Note

Gain of antenna in dBi =  $10 \cdot \log(G)$ .

The regulations require that the power used for the calculations is the maximum power in the transmit burst subject to allowance for source-based time-averaging.

At 2.4 GHz, 5.4 GHz and EU 5.8 GHz the products are generally limited to a fixed EIRP which can be achieved with the Integrated Antenna. The calculations above assume that the maximum EIRP allowed by the regulations is being transmitted.



Note

If there are no EIRP limits in the country of installation, use the distance calculations for FCC 5.8 GHz for all frequency bands.

Table 156 through Table 163 below are the power compliance margins for the following devices:

Model Number	Part Number	FCC ID	Industry Canada
C058900P072A	C058900C072A	Z8H89FT0015	109W-0015
C058900P062A	C058900C062A	Z8H89FT0015	109W-0015

**Table 159** ePMP 1000 Power compliance margins, 5.1 GHz, AP

Connection Type	Antenna	P (W)	G	S (W/m <sup>2</sup> )	d (m)	R (m)	C
PMP	Modular Array, 17 dBi	0.079	50.1	9.011	0.19	0.4	45.5
PMP	Modular Dish, 24 dBi	0.016	251.2	9.011	0.19	0.4	45.5
PMP	Module Dipole, 2 dBi	0.398	1.6	9.011	0.07	0.2	71.8
PTP	Modular Array, 17 dBi	0.398	50.1	9.011	0.42	1	56.7
PTP	Modular Dish, 24 dBi	0.398	251.2	9.011	0.94	2	45.3
PTP	Module Dipole, 2 dBi	0.398	1.6	9.011	0.07	0.2	71.8

**Table 160** ePMP 1000 Power compliance margins, 5.2 GHz, AP

Channel Bandwidth	Antenna	P (W)	G	S (W/m <sup>2</sup> )	d (m)	R (m)	C
10 MHz	Modular Array, 17 dBi	0.010	50.1	9.130	0.07	0.2	93.2
10 MHz	Modular Dish, 24 dBi	0.002	251.2	9.130	0.06	0.2	94.7
10 MHz	Module Dipole, 2 dBi	0.118	1.6	9.130	0.04	0.1	61.3
20/40 MHz	Modular Array, 17 dBi	0.019	50.1	9.130	0.09	0.2	48.8
20/40 MHz	Modular Dish, 24 dBi	0.004	251.2	9.130	0.09	0.2	49.6
20/40 MHz	Module Dipole, 2 dBi	0.112	1.6	9.130	0.04	0.1	64.8

**Table 161** ePMP 1000 Power compliance margins, 5.4 GHz, AP

Channel Bandwidth	Antenna	P (W)	G	S (W/m <sup>2</sup> )	d (m)	R (m)	C
10 MHz	Modular Array, 17 dBi	0.008	50.1	9.390	0.06	0.2	118.2
10 MHz	Modular Dish, 24 dBi	0.002	251.2	9.390	0.06	0.2	103.2

10 MHz	Module Dipole, 2 dBi	0.095	1.6	9.390	0.04	0.1	77.9
20/40 MHz	Modular Array, 17 dBi	0.010	50.1	9.390	0.07	0.2	90.7
20/40 MHz	Modular Dish, 24 dBi	0.003	251.2	9.390	0.08	0.2	69.5
20/40 MHz	Module Dipole, 2 dBi	0.163	1.6	9.390	0.05	0.1	45.7

**Table 162** ePMP 1000 Power compliance margins, 5.8 GHz, AP

Connection Type	Antenna	P (W)	G	S (W/m <sup>2</sup> )	d (m)	R (m)	C
PMP	Modular Array, 17 dBi	0.079	50.1	9.687	0.18	0.4	48.9
PMP	Modular Dish, 24 dBi	0.016	251.2	9.687	0.18	0.4	48.9
PMP	Module Dipole, 2 dBi	0.398	1.6	9.687	0.07	0.2	77.1
PTP	Modular Array, 17 dBi	0.501	50.1	9.687	0.45	1	48.4
PTP	Modular Dish, 24 dBi	0.501	251.2	9.687	1.02	2	38.7
PTP	Module Dipole, 2 dBi	0.501	1.6	9.687	0.08	0.2	61.3

**Table 163** ePMP 1000 Power compliance margins, 5.1 GHz, SM

Antenna	P (W)	G	S (W/m <sup>2</sup> )	d (m)	R (m)	C
Modular Array, 17 dBi	0.398	50.1	9.011	0.42	1	56.7
Modular Dish, 24 dBi	0.398	251.2	9.011	0.94	2	45.3
Module Dipole, 2 dBi	0.398	1.6	9.011	0.07	0.2	71.8

**Table 164** Power compliance margins, 5.2 GHz, SM

Channel Bandwidth	Antenna	P (W)	G	S (W/m <sup>2</sup> )	d (m)	R (m)	C
5/10 MHz	Modular Array, 17 dBi	0.010	50.1	9.130	0.07	0.2	93.2
5/10 MHz	Modular Dish, 24 dBi	0.002	251.2	9.130	0.06	0.2	94.7
5/10 MHz	Module Dipole, 2 dBi	0.118	1.6	9.130	0.04	0.1	61.3
20/40 MHz	Modular Array, 17 dBi	0.019	50.1	9.130	0.09	0.2	48.8
20/40 MHz	Modular Dish, 24 dBi	0.004	251.2	9.130	0.09	0.2	49.6



20/40 MHz	Module Dipole, 2 dBi	0.112	1.6	9.130	0.04	0.1	64.8
-----------	----------------------	-------	-----	-------	------	-----	------

**Table 165** ePMP 1000 Power compliance margins, 5.4 GHz, SM

Channel Bandwidth	Antenna	P (W)	G	S (W/m <sup>2</sup> )	d (m)	R (m)	C
5/10 MHz	Modular Array, 17 dBi	0.008	50.1	9.390	0.06	0.2	118.2
5/10 MHz	Modular Dish, 24 dBi	0.002	251.2	9.390	0.06	0.2	103.2
5/10 MHz	Module Dipole, 2 dBi	0.095	1.6	9.390	0.04	0.1	77.9
20/40 MHz	Modular Array, 17 dBi	0.010	50.1	9.390	0.07	0.2	90.7
20/40 MHz	Modular Dish, 24 dBi	0.003	251.2	9.390	0.08	0.2	69.5
20/40 MHz	Module Dipole, 2 dBi	0.163	1.6	9.390	0.05	0.1	45.7

**Table 166** ePMP 1000 Power compliance margins, 5.8 GHz, SM

Antenna	P (W)	G	S (W/m <sup>2</sup> )	d (m)	R (m)	C
Modular Array, 17 dBi	0.501	50.1	9.687	0.45	1	48.4
Modular Dish, 24 dBi	0.501	251.2	9.687	1.02	2	38.7
Module Dipole, 2 dBi	0.501	1.6	9.687	0.08	0.2	61.3

Table 165 below is the power compliance margins for the following device

Model Number	Part Number	FCC ID	Industry Canada
C024900P161A	C024900C161A	Z8H89FT0019	109W-0019

Table 167 ePMP 1000 Power compliance margins, 2.4 GHz (FCC)

Channel Bandwidth	Antenna	P (W)	G	S (W/m <sup>2</sup> )	d (m)	R (m)	C
40/20/10 MHz	Modular Dish, 17 dBi	0.293	50.1	5.348	0.47	1	45.7
40/20/10 MHz	Module Dipole, 2 dBi	0.807	1.6	5.348	0.14	0.3	47.3
5 MHz	Modular Dish, 17 dBi	0.287	50.1	5.348	0.46	1	46.6
5 MHz	Module Dipole, 2 dBi	0.802	1.6	5.348	0.14	0.3	47.6

Table 168 ePMP 1000 Power compliance margins, 2.4 GHz (ISED)

Channel Bandwidth	Antenna	P (W)	G	S (W/m <sup>2</sup> )	d (m)	R (m)	C
40/20/10 MHz	Modular Dish, 17 dBi	0.293	50.1	5.348	0.47	1	45.7
40/20/10 MHz	Module Dipole, 2 dBi	0.807	1.6	5.348	0.14	0.4	84.0
5 MHz	Modular Dish, 17 dBi	0.287	50.1	5.348	0.46	1	46.6
5 MHz	Module Dipole, 2 dBi	0.802	1.6	5.348	0.14	0.3	47.6

Table 166 through Table 173 below are the power compliance margins for the following devices:

Model Number	Part Number	FCC ID	Industry Canada
C058900P082A	C058900C082A	Z8H89FT0031	109W-0031

Table 169 ePMP 1000 Power compliance margins, 5.1 GHz, SM (ISED)

Antenna	P (W)	G	S (W/m <sup>2</sup> )	d (m)	R (m)	S @ 20 cm (W/m <sup>2</sup> )
Modular Dish, 22 dBi	0.398	158	9.011	0.75	2	125.49

Table 170 ePMP 1000 Power compliance margins, 5.1 GHz, SM (FCC)

Antenna	P (W)	G	S (W/m <sup>2</sup> )	d (m)	R (m)
Modular Dish, 22 dBi	0.398	158	10	0.71	2

**Table 171** Power compliance margins, 5.2 GHz, SM (ISED)

Antenna	P (W)	G	S (W/m <sup>2</sup> )	d (m)	R (m)	S @ 20 cm (W/m <sup>2</sup> )
Modular Dish, 22 dBi	0.00229	158	9.14	0.06	0.2	0.72

**Table 172** Power compliance margins, 5.2 GHz, SM (FCC)

Antenna	P (W)	G	S (W/m <sup>2</sup> )	d (m)	R (m)
Modular Dish, 22 dBi	0.00305	158	10	0.06	0.2

**Table 173** ePMP 1000 Power compliance margins, 5.4 GHz, SM (ISED)

Antenna	P (W)	G	S (W/m <sup>2</sup> )	d (m)	R (m)	S @ 20 cm (W/m <sup>2</sup> )
Modular Dish, 22 dBi	0.00277	158	9.54	0.06	0.2	0.87

**Table 174** ePMP 1000 Power compliance margins, 5.4 GHz, SM (FCC)

Antenna	P (W)	G	S (W/m <sup>2</sup> )	d (m)	R (m)
Modular Dish, 22 dBi	0.00307	158	10	0.06	0.2

**Table 175** ePMP 1000 Power compliance margins, 5.8 GHz, SM (ISED)

Antenna	P (W)	G	S (W/m <sup>2</sup> )	d (m)	R (m)	S @ 20 cm (W/m <sup>2</sup> )
Modular Dish, 22 dBi	0.501	158	9.687	0.81	2	157.97

**Table 176** ePMP 1000 Power compliance margins, 5.8 GHz, SM (FCC)

Antenna	P (W)	G	S (W/m <sup>2</sup> )	d (m)	R (m)
Modular Dish, 22 dBi	0.501	158	10	0.79	2

## Compliance with radio regulations

This section describes how the ePMP complies with the radio regulations that are enforced in various countries.



Caution

Changes or modifications not expressly approved by Cambium Networks could void the user's authority to operate the system.

### TYPE APPROVALS

This system has achieved Type Approval in various countries around the world. This means that the system has been tested against various local technical regulations and found to comply. The frequency bands in which the system operates may be unlicensed and, in these bands, the system can be used provided it does not cause interference. The system is not guaranteed protection against interference from other products and installations.

The radio specification type approvals that have been granted for ePMP frequency variants are listed under [Table 140](#).

**Table 177** ePMP 2000 Radio certifications

Frequency band	Region	Regulatory approvals
5 GHz	USA	FCC Part 15 Class B
	Canada	IC RSS-210 Issue 8, Annex 8 (or latest) IC RSS247 Issue 2 (Feb 2017)
	Europe	ETSI EN302 502 v1.2.1 ETSI EN301 893 v1.7.1

**Table 178** ePMP 1000 Radio certifications

Frequency band	Region	Regulatory approvals
2.4 GHz, 5 GHz	USA	FCC Part 15 Class B
	Canada	IC RSS-210 Issue 8, Annex 8 (or latest) IC RSS247 Issue 2 (Feb 2017)
	Europe	ETSI EN302 502 v1.2.1 ETSI EN301 893 v1.7.1

### FCC AND ETSI COMPLIANCE TESTING

The system has been tested for compliance to both US (FCC) and European (ETSI) specifications. It has been shown to comply with the limits for emitted spurious radiation for a Class B digital device, pursuant to Part 15 of the FCC Rules in the USA and appropriate European ENs. These limits have been designed to provide reasonable protection against harmful interference. However the equipment can radiate radio frequency energy and, if not installed and used in accordance with the instructions, may cause harmful interference to other radio communications. There is no guarantee that interference will not occur in a particular installation. To comply with FCC RF exposure limits for general population or uncontrolled exposure, the antenna(s) used for the ePMP transmitter must be installed to ensure a separation distance specified in [Table 141](#) through [Table 165](#) from all persons and must not be co-located or operating in conjunction with any other antenna or transmitter.

## OEM Responsibilities to comply with FCC and Industry Canada Regulations

The ePMP Module is certified for integration into products only by OEM integrators under the following conditions:

1. The antennas(s) must be installed such that a minimum separation distance specified in **Table 141** through **Table 165** is maintained between the radiator (antenna) and all persons at all times.
2. The transmitter module must not be co-located or operate in conjunction with any other antenna or transmitter. As long as the two conditions above are met, further transmitter testing is not required. However, the OEM integrator is still responsible for testing their end-product for any additional compliance requirements required with this module installed (for example, digital device emissions, PC peripheral requirements, etc.).



Note

In the event that these conditions cannot be met (for certain configurations or co-location with another transmitter), then the FCC and Industry Canada authorizations are no longer considered valid and the FCC ID cannot be used.



Note

A Class B Digital Device is a device that is marketed for use in a residential environment, notwithstanding use in commercial, business and industrial environments.

Notwithstanding that Cambium Networks has designed (and qualified) the ePMP products to generally meet the Class B requirement to minimize the potential for interference, the ePMP product range is not marketed for use in a residential environment.

### End Product Labeling

The ePMP Module is labeled with its own FCC ID and IC Certification Number. If the FCC ID and IC Certification Number are not visible when the module is installed inside another device, then the outside of the device into which the module is installed must also display a label referring to the enclosed module. In that case, the final end product must be labeled in a visible area with the following:

**Table 179** ePMP 2000 Product labeling

Region	Label
Access Point (AP)	“Contains Transmitter Module FCC ID: Z8H89FT0020” or “Contains FCC ID: Z8H89FT0020”

**Table 180** ePMP 1000 Product labeling

Device Function	Label
Access Point (AP)	“Contains Transmitter Module FCC ID: Z8H89FT0006” or “Contains FCC ID: Z8H89FT0006”
Subscriber Module (SM)	“Contains Transmitter Module FCC ID: Z8H89FT0005” or “Contains FCC ID: Z8H89FT0005” or “Contains FCC ID: Z8H89FT0031”
Access Point (AP) / Subscriber Module (SM)	“Contains Transmitter Module FCC ID: Z8H89FT0015” or “Contains FCC ID: Z8H89FT0015”
Access Point (AP) / Subscriber Module (SM)	“Contains Transmitter Module FCC ID: Z8H89FT0019” or “Contains FCC ID: Z8H89FT0019”



## EXAMPLES OF REGULATORY LIMITS

Examples of the regulatory limits that apply in typical regions of operation are in the following tables:

- 4.9 GHz – [Table 178](#)
- 5.1 GHz – [Table 179](#)
- 5.2 GHz – [Table 181](#)
- 5.3 GHz – [Table 182](#)
- 5.4 GHz – [Table 183](#)
- 5.8 GHz/5.9 GHz – [Table 184](#)
- 2.4 GHz – [Table 185](#)
- 2.5 GHz – [Table 186](#)

**Table 181** Regulatory limits – 4.9 GHz

Country	Frequency range	Valid Center Frequency for 20 MHz Band	Valid Center Frequency for 40 MHz Band	Valid Center Frequency for 5/10 MHz Band	Conducted Power
Other	4900-5150	4920 to 5155 every 5MHz	4930 to 5165 every 5MHz	4920 to 5150 every 5MHz	15 for 4920 to 4995, 19 for 5000 to 5080, 27 for 5085 to 5165

**Table 182** Regulatory Limits - 5.1 GHz

Country	Frequency range	Valid Center Frequency for 20 MHz Band	Valid Center Frequency for 40 MHz Band	Valid Center Frequency for 5/10 MHz Band	Conducted Power	EIRP Power
Armenia	5150-5250	5160-5240 every 5 MHz	5170-5230 every 5 MHz	5155-5250 every 5 MHz	20	
Argentina	5150-5250	5160-5240 every 5 MHz	5170-5230 every 5 MHz	5155-5250 every 5 MHz	20	
Azerbaijan	5150-5250	5160-5240 every 5 MHz	5170-5230 every 5 MHz	5155-5250 every 5 MHz	20	
Belarus	5150-5250	5160-5240 every 5 MHz	5170-5230 every 5 MHz	5155-5250 every 5 MHz	20	
Ecuador	5150-5250	5160-5240 every 5 MHz	5170-5230 every 5 MHz	5155-5250 every 5 MHz	20	
Georgia	5150-5250	5160-5240 every 5 MHz	5170-5230 every 5 MHz	5155-5250 every 5 MHz	20	
Guam	5150-5250	5180-5240 every 5 MHz	5190-5230 every 5 MHz	5160-5245 every 5 MHz	20	36 for non PTP AP. 53 for other modes.
Kyrgyzstan	5150-5250	5160-5240 every 5 MHz	5170-5230 every 5 MHz	5155-5250 every 5 MHz	20	
Kazakhstan	5150-5250	5160-5240 every 5 MHz	5170-5230 every 5 MHz	5155-5250 every 5 MHz	20	

Country	Frequency range	Valid Center Frequency for 20 MHz Band	Valid Center Frequency for 40 MHz Band	Valid Center Frequency for 5/10 MHz Band	Conducted Power	EIRP Power
Moldova	5150-5250	5160-5240 every 5 MHz	5170-5230 every 5 MHz	5155-5250 every 5 MHz	20	
Malaysia	5150-5250	5160-5240 every 5 MHz	5170-5230 every 5 MHz	5155-5250 every 5 MHz	20	
Other	5150-5250	5160-5250 every 5 MHz	5170-5250 every 5 MHz	5155-5250 every 5 MHz	27	
Peru	5150-5250	5160-5240 every 5 MHz	5170-5230 every 5 MHz	5155-5250 every 5 MHz	20	
Philippines	5150-5250	5160-5240 every 5 MHz	5170-5230 every 5 MHz	5155-5250 every 5 MHz	20	
Puerto Rico	5150-5250	5180-5240 every 5 MHz	5190-5230 every 5 MHz	5160-5245 every 5 MHz	20	36 for non PTP AP. 53 for other modes.
Russia	5150-5250	5160-5240 every 5 MHz	5170-5230 every 5 MHz	5155-5250 every 5 MHz	20	
Tajikistan	5150-5250	5160-5240 every 5 MHz	5170-5230 every 5 MHz	5155-5250 every 5 MHz	20	
Turkmenistan	5150-5250	5160-5240 every 5 MHz	5170-5230 every 5 MHz	5155-5250 every 5 MHz	20	
Ukraine	5150-5250	5160-5240 every 5 MHz	5170-5230 every 5 MHz	5155-5250 every 5 MHz	18	
Uganda	5150-5250	5160-5240 every 5 MHz	5170-5230 every 5 MHz	5155-5250 every 5 MHz	27	30
United States	5150-5250	5180-5240 every 5 MHz	5190-5230 every 5 MHz	5160-5245 every 5 MHz	20	36 for non PTP AP. 53 for other modes.
Uzbekistan	5150-5250	5160-5240 every 5 MHz	5170-5230 every 5 MHz	5155-5250 every 5 MHz	20	
Venezuela	5150-5250	5160-5240 every 5 MHz	5170-5230 every 5 MHz	5155-5250 every 5 MHz	20	
U.S. Virgin Islands	5150-5250	5180-5240 every 5 MHz	5190-5230 every 5 MHz	5160-5245 every 5 MHz	20	36 for non PTP AP. 53 for other modes.



#### Caution

For countries that follow FCC regulations, the combined conducted power must be reduced according to [Table 180](#) for the lower edge of the 5.1 GHz band in order to meet restricted band requirements.



**Table 183** FCC conducted power (combined) for lower edge of 5.1 GHz

Channel Bandwidth	Antenna	Conducted Power (combined)
5/10 MHz	Connectorized Omni, 3 dBi	18 dBm
5/10 MHz	Integrated Patch Array, 16 dBi	7 dBm
5/10 MHz	Connectorized Sector Array, 16 dBi	7 dBm
5/10 MHz	Connectorized Patch Panel Array, 23 dBi	0 dBm
5/10 MHz	Connectorized Dish, 30 dBi	-7 dBm
20/40 MHz	Connectorized Omni, 3 dBi	15 dBm
20/40 MHz	Integrated Patch Array, 16 dBi	7 dBm
20/40 MHz	Connectorized Sector Array, 16 dBi	7 dBm
20/40 MHz	Connectorized Patch Panel Array, 23 dBi	2 dBm
20/40 MHz	Connectorized Dish, 30 dBi	-5 dBm

**Table 184** Regulatory limits - 5.2 GHz

Country	Frequency range	Valid Center Frequency for 20 MHz Band	Valid Center Frequency for 40 MHz Band	Valid Center Frequency for 5/10 MHz Band <sup>2</sup>	Conducted Power	EIRP Power	DFS
Armenia	5250-5350	5270 to 5330 every 5MHz	5280 to 5320 every 5MHz	5255 to 5345 every 5MHz	18		No
Argentina	5250-5350	5260 to 5340 every 5MHz	5270 to 5330 every 5MHz	5255 to 5345 every 5MHz	18		Yes
Azerbaijan	5250-5350	5260 to 5340 every 5MHz	5270 to 5330 every 5MHz	5255 to 5345 every 5MHz	18		No
Belarus	5250-5350	5260 to 5340 every 5MHz	5270 to 5330 every 5MHz	5255 to 5345 every 5MHz	18		No
Canada	5250-5350	5280 to 5320 every 5MHz	5290 to 5310 every 5MHz	5280 to 5320 every 5MHz	12 for 20 MHz, 13 for 40 MHz	30 for 20 MHz and 40 MHz, 27 for 10 MHz, 24 for 5 MHz	Yes
Chile	5250-5350	5270 to 5330 every 5MHz	5280 to 5320 every 5MHz	5255 to 5345 every 5MHz	18		Yes
Colombia	5250-5350	5270 to 5330 every 5MHz	5280 to 5320 every 5MHz	5255 to 5345 every 5MHz	18		Yes
Ecuador	5250-5350	5260 to 5340 every 5MHz	5270 to 5330 every 5MHz	5255 to 5345 every 5MHz	18		No
Georgia	5250-5350	5260 to 5340 every 5MHz	5270 to 5330 every 5MHz	5255 to 5345 every 5MHz	18		No
Ghana	5250-5350	5270 to 5330 every 5MHz	5280 to 5320 every 5MHz	5255 to 5345 every 5MHz	18		Yes

<sup>2</sup> 5 MHz Channel bandwidth not available for DFS regions/bands.

Country	Frequency range	Valid Center Frequency for 20 MHz Band	Valid Center Frequency for 40 MHz Band	Valid Center Frequency for 5/10 MHz Band <sup>2</sup>	Conducted Power	EIRP Power	DFS
Guam	5250-5350	5245 to 5320 every 5MHz	5235 to 5310 every 5MHz	5250 to 5320 every 5MHz	13	30 for 20 MHz and 40 MHz, 27 for 10 MHz, 24 for 5 MHz	Yes
Hong Kong	5250-5350	5270 to 5330 every 5MHz	5280 to 5320 every 5MHz	5255 to 5345 every 5MHz	18		Yes
Kazakhstan	5250-5350	5260 to 5340 every 5MHz	5270 to 5330 every 5MHz	5255 to 5345 every 5MHz	18		No
Kenya	5250-5350	5270 to 5330 every 5MHz	5280 to 5320 every 5MHz	5255 to 5345 every 5MHz	18		Yes
Kyrgyzstan	5250-5350	5260 to 5340 every 5MHz	5270 to 5330 every 5MHz	5255 to 5345 every 5MHz	18		No
Malaysia	5250-5350	5270 to 5330 every 5MHz	5280 to 5320 every 5MHz	5255 to 5345 every 5MHz	18		Yes
Moldova	5250-5350	5255 to 5350 every 5MHz	5255 to 5350 every 5MHz	5255 to 5350 every 5MHz	27		No
Nigeria	5250-5350	5270 to 5330 every 5MHz	5280 to 5320 every 5MHz	5255 to 5345 every 5MHz	27	36	Yes
Other	5250-5350	5270 to 5330 every 5MHz	5280 to 5320 every 5MHz	5255 to 5345 every 5MHz	18		No
Peru	5250-5350	5245 to 5320 every 5MHz	5235 to 5310 every 5MHz	5250 to 5320 every 5MHz	13	30 for 20 MHz and 40 MHz, 27 for 10 MHz, 24 for 5 MHz	Yes
Philippines	5250-5350	5260 to 5340 every 5MHz	5270 to 5330 every 5MHz	5255 to 5345 every 5MHz	18		Yes
Puerto Rico	5250-5350	5280 to 5320 every 5MHz	5290 to 5310 every 5MHz	5255 to 5345 every 5MHz	13	30	Yes
Russia	5250-5350	5260 to 5340 every 5MHz	5270 to 5330 every 5MHz	5255 to 5345 every 5MHz	18		No
Taiwan	5250-5350	5270 to 5330 every 5MHz	5280 to 5320 every 5MHz	5255 to 5345 every 5MHz	13	23	Yes
Tajikistan	5250-5350	5260 to 5340 every 5MHz	5270 to 5330 every 5MHz	5255 to 5345 every 5MHz	18		No
Thailand	5250-5350	5245 to 5320 every 5MHz	5235 to 5310 every 5MHz	5250 to 5320 every 5MHz	13	30 for 20 MHz and 40 MHz, 27 for 10 MHz, 24 for 5 MHz	FCC
Turkmenistan	5250-5350	5260 to 5340 every 5MHz	5270 to 5330 every 5MHz	5255 to 5345 every 5MHz	18		No
U.S. Virgin Islands	5250-5350	5260 to 5340 every 5MHz	5270 to 5330 every 5MHz	5255 to 5345 every 5MHz	18	30	Yes
Uganda	5250-5350	5270 to 5330 every 5MHz	5280 to 5320 every 5MHz	5255 to 5345 every 5MHz	18		Yes
Ukraine	5250-5350	5260 to 5340 every 5MHz	5270 to 5330 every 5MHz	5255 to 5345 every 5MHz	18		No
United States	5250-5350	5260 to 5340 every 5MHz	5270 to 5330 every 5MHz	5255 to 5345 every 5MHz	18	30	Yes
Uzbekistan	5250-5350	5260 to 5340 every 5MHz	5270 to 5330 every 5MHz	5255 to 5345 every 5MHz	18		No
Venezuela	5250-5350	5280 to 5320 every 5MHz	5290 to 5310 every 5MHz	5280 to 5320 every 5MHz	12 for 20 MHz, 13 for 40 MHz	30 for 20 MHz and 40 MHz, 27 for 10 MHz, 24 for 5 MHz	No

**Table 185** Regulatory limits - 5.3 GHz

Country	Frequency range	Valid Center Frequency for 20 MHz Band	Valid Center Frequency for 40 MHz Band	Valid Center Frequency for 5/10 MHz Band	Conducted Power	EIRP Power	DFS
Other	5350-5470	5355 to 5470 every 5MHz	5355 to 5470 every 5MHz	5355 to 5470 every 5MHz	27		No

**Table 186** Regulatory limits - 5.4 GHz

Country	Frequency range	Valid Center Frequency for 20 MHz Band	Valid Center Frequency for 40 MHz Band	Valid Center Frequency for 5/10 MHz Band <sup>3</sup>	Conducted Power	EIRP Power	DFS
Argentina	5470-5725	5480 to 5730 every 5MHz	5490 to 5740 every 5MHz	5475 to 5725 every 5MHz	19		None
Armenia	5470-5725	5480 to 5730 every 5MHz	5490 to 5740 every 5MHz	5475 to 5725 every 5MHz	19		None
Australia	5470-5600, 5650-5725	5480 to 5590 every 5MHz, 5660 to 5715 every 5 MHz	5490 to 5580 every 5MHz, 5670 to 5705 every 5 MHz	5475 to 5595 every 5MHz, 5655 to 5720 every 5 MHz	15	30 for 20 MHz and 40 MHz, 27 for 10 MHz, 24 for 5 MHz	ETSI
Austria	5470-5600, 5650-5725	5480 to 5590 every 5MHz, 5660 to 5715 every 5 MHz	5490 to 5580 every 5MHz, 5670 to 5705 every 5 MHz	5475 to 5595 every 5MHz, 5655 to 5720 every 5 MHz	15	30 for 20 MHz and 40MHz, 27 for 10 MHz, 24 for 5 MHz	ETSI
Azerbaijan	5470-5725	5480 to 5730 every 5MHz	5490 to 5740 every 5MHz	5475 to 5725 every 5MHz	19		None
Belarus	5470-5725	5480 to 5730 every 5MHz	5490 to 5740 every 5MHz	5475 to 5725 every 5MHz	19		None
Belgium	5470-5600, 5650-5725	5480 to 5590 every 5MHz, 5660 to 5715 every 5 MHz	5490 to 5580 every 5MHz, 5670 to 5705 every 5 MHz	5475 to 5595 every 5MHz, 5655 to 5720 every 5 MHz	15	30 for 20 MHz and 40MHz, 27 for 10 MHz, 24 for 5 MHz	ETSI
Bosnia and Herzegovina	5470-5600, 5650-5725	5480 to 5590 every 5MHz, 5660 to 5715 every 5 MHz	5490 to 5580 every 5MHz, 5670 to 5705 every 5 MHz	5475 to 5595 every 5MHz, 5655 to 5720 every 5 MHz	15	30 for 20 MHz and 40MHz, 27 for 10 MHz, 24 for 5 MHz	ETSI
Brazil	5470-5725	5480 to 5715 every 5MHz	5490 to 5705 every 5MHz	5475 to 5720 every 5MHz	16	30	FCC
Bulgaria	5470-5600, 5650-5725	5480 to 5590 every 5MHz, 5660 to 5715 every 5 MHz	5490 to 5580 every 5MHz, 5670 to 5705 every 5 MHz	5475 to 5595 every 5MHz, 5655 to 5720 every 5 MHz	15	30 for 20 MHz and 40MHz, 27 for 10 MHz, 24 for 5 MHz	ETSI
Canada	5470-5600, 5650-5725	5495 to 5590 every 5MHz, 5660 to 5705 every 5 MHz	5510 to 5580 every 5MHz, 5670 to 5695 every 5 MHz	5495 to 5595 every 5MHz, 5655 to 5705 every 5 MHz	14	30 for 20 MHz and 40MHz, 27 for 10 MHz, 24 for 5 MHz	FCC
Chile	5470-5725	5480 to 5715 every 5MHz	5490 to 5705 every 5MHz	5475 to 5720 every 5MHz	16	30	FCC
Colombia	5470-5725	5480 to 5715 every 5MHz	5490 to 5705 every 5MHz	5475 to 5720 every 5MHz	16	30	FCC
Croatia	5470-5600, 5650-5725	5480 to 5590 every 5MHz, 5660 to 5715 every 5 MHz	5490 to 5580 every 5MHz, 5670 to 5705 every 5 MHz	5475 to 5595 every 5MHz, 5655 to 5720 every 5 MHz	15	30 for 20 MHz and 40MHz, 27 for 10 MHz, 24 for 5 MHz	ETSI
Cyprus	5470-5600, 5650-5725	5480 to 5590 every 5MHz, 5660 to 5715 every 5 MHz	5490 to 5580 every 5MHz, 5670 to 5705 every 5 MHz	5475 to 5595 every 5MHz, 5655 to 5720 every 5 MHz	15	30 for 20 MHz and 40MHz, 27 for 10 MHz, 24 for 5 MHz	ETSI
Czech Republic	5470-5600, 5650-5725	5480 to 5590 every 5MHz, 5660 to 5715 every 5 MHz	5490 to 5580 every 5MHz, 5670 to 5705 every 5 MHz	5475 to 5595 every 5MHz, 5655 to 5720 every 5 MHz	15	30 for 20 MHz and 40MHz, 27 for 10 MHz, 24 for 5 MHz	ETSI
Denmark	5470-5600, 5650-5725	5480 to 5590 every 5MHz, 5660 to 5715 every 5 MHz	5490 to 5580 every 5MHz, 5670 to 5705 every 5 MHz	5475 to 5595 every 5MHz, 5655 to 5720 every 5 MHz	15	30 for 20M and 40M, 27 for 10M, 24 for 5M	ETSI

<sup>3</sup> 5 MHz Channel bandwidth not available for DFS regions/bands.

Country	Frequency range	Valid Center Frequency for 20 MHz Band	Valid Center Frequency for 40 MHz Band	Valid Center Frequency for 5/10 MHz Band <sup>3</sup>	Conducted Power	EIRP Power	DFS
Ecuador	5470-5725	5480 to 5715 every 5MHz	5490 to 5705 every 5MHz	5475 to 5720 every 5MHz	16	30 for 20 MHz and 40MHz, 27 for 10 MHz, 24 for 5 MHz	None
Finland	5470-5600, 5650-5725	5480 to 5590 every 5MHz, 5660 to 5715 every 5 MHz	5490 to 5580 every 5MHz, 5670 to 5705 every 5 MHz	5475 to 5595 every 5MHz, 5655 to 5720 every 5 MHz	15	30 for 20 MHz and 40MHz, 27 for 10 MHz, 24 for 5 MHz	ETSI
France	5470-5600, 5650-5725	5480 to 5590 every 5MHz, 5660 to 5715 every 5 MHz	5490 to 5580 every 5MHz, 5670 to 5705 every 5 MHz	5475 to 5595 every 5MHz, 5655 to 5720 every 5 MHz	15	30 for 20 MHz and 40MHz, 27 for 10 MHz, 24 for 5 MHz	ETSI
Generic ETSI	5470-5600, 5650-5725	5480 to 5590 every 5MHz, 5660 to 5715 every 5 MHz	5490 to 5580 every 5MHz, 5670 to 5705 every 5 MHz	5475 to 5595 every 5MHz, 5655 to 5720 every 5 MHz	15	30 for 20 MHz and 40MHz, 27 for 10 MHz, 24 for 5 MHz	ETSI
Georgia	5470-5725	5480 to 5730 every 5MHz	5490 to 5740 every 5MHz	5475 to 5725 every 5MHz	19		None
Germany	5470-5600, 5650-5725	5480 to 5590 every 5MHz, 5660 to 5715 every 5 MHz	5490 to 5580 every 5MHz, 5670 to 5705 every 5 MHz	5475 to 5595 every 5MHz, 5655 to 5720 every 5 MHz	15	30 for 20 MHz and 40MHz, 27 for 10 MHz, 24 for 5 MHz	ETSI
Ghana	5470-5725	5480 to 5715 every 5MHz	5490 to 5705 every 5MHz	5475 to 5720 every 5MHz	16	30	FCC
Greece	5470-5600, 5650-5725	5480 to 5590 every 5MHz, 5660 to 5715 every 5 MHz	5490 to 5580 every 5MHz, 5670 to 5705 every 5 MHz	5475 to 5595 every 5MHz, 5655 to 5720 every 5 MHz	15	30 for 20 MHz and 40MHz, 27 for 10 MHz, 24 for 5 MHz	ETSI
Guam	5470-5600, 5650-5725	5495 to 5590 every 5MHz, 5660 to 5705 every 5 MHz	5510 to 5580 every 5MHz, 5670 to 5695 every 5 MHz	5495 to 5595 every 5MHz, 5655 to 5705 every 5 MHz	14	30 for 20 MHz and 40MHz, 27 for 10 MHz, 24 for 5 MHz	FCC
Hong Kong	5470-5725	5480 to 5715 every 5MHz	5490 to 5705 every 5MHz	5475 to 5720 every 5MHz	15	30	FCC
Hungary	5470-5600, 5650-5725	5480 to 5590 every 5MHz, 5660 to 5715 every 5 MHz	5490 to 5580 every 5MHz, 5670 to 5705 every 5 MHz	5475 to 5595 every 5MHz, 5655 to 5720 every 5 MHz	15	30 for 20 MHz and 40MHz, 27 for 10 MHz, 24 for 5 MHz	ETSI
Ireland	5470-5600, 5650-5725	5480 to 5590 every 5MHz, 5660 to 5715 every 5 MHz	5490 to 5580 every 5MHz, 5670 to 5705 every 5 MHz	5475 to 5595 every 5MHz, 5655 to 5720 every 5 MHz	15	30 for 20 MHz and 40MHz, 27 for 10 MHz, 24 for 5 MHz	ETSI
Italy	5470-5600, 5650-5725	5480 to 5590 every 5MHz, 5660 to 5715 every 5 MHz	5490 to 5580 every 5MHz, 5670 to 5705 every 5 MHz	5475 to 5595 every 5MHz, 5655 to 5720 every 5 MHz	15	30 for 20 MHz and 40MHz, 27 for 10 MHz, 24 for 5 MHz	ETSI
Kazakhstan	5470-5725	5480 to 5730 every 5MHz	5490 to 5740 every 5MHz	5475 to 5725 every 5MHz	19		
Kenya	5470-5725	5480 to 5715 every 5MHz	5490 to 5705 every 5MHz	5475 to 5720 every 5MHz	16	30 for 20 MHz and 40MHz, 27 for 10 MHz, 24 for 5 MHz	FCC
Kyrgyzstan	5470-5725	5480 to 5730 every 5MHz	5490 to 5740 every 5MHz	5475 to 5725 every 5MHz	19		None
Latvia	5470-5600, 5650-5725	5480 to 5590 every 5MHz, 5660 to 5715 every 5 MHz	5490 to 5580 every 5MHz, 5670 to 5705 every 5 MHz	5475 to 5595 every 5MHz, 5655 to 5720 every 5 MHz	15	30 for 20 MHz and 40MHz, 27 for 10 MHz, 24 for 5 MHz	ETSI
Liechtenstein	5470-5600, 5650-5725	5480 to 5590 every 5MHz,	5490 to 5580 every 5MHz,	5475 to 5595 every 5MHz,	15	30 for 20 MHz and 40MHz, 27 for 10 MHz,	ETSI

Country	Frequency range	Valid Center Frequency for 20 MHz Band	Valid Center Frequency for 40 MHz Band	Valid Center Frequency for 5/10 MHz Band 3	Conducted Power	EIRP Power	DFS
Lithuania	5470-5600, 5650-5725	5660 to 5715 every 5 MHz	5670 to 5705 every 5 MHz	5655 to 5720 every 5 MHz	15	MHz, 24 for 5 MHz	ETSI
		5480 to 5590 every 5MHz, 5660 to 5715 every 5 MHz	5490 to 5580 every 5MHz, 5670 to 5705 every 5 MHz	5475 to 5595 every 5MHz, 5655 to 5720 every 5 MHz		30 for 20 MHz and 40MHz, 27 for 10 MHz, 24 for 5 MHz	
Luxembourg	5470-5600, 5650-5725	5480 to 5590 every 5MHz, 5660 to 5715 every 5 MHz	5490 to 5580 every 5MHz, 5670 to 5705 every 5 MHz	5475 to 5595 every 5MHz, 5655 to 5720 every 5 MHz	15	30 for 20 MHz and 40MHz, 27 for 10 MHz, 24 for 5 MHz	ETSI
		5480 to 5590 every 5MHz, 5660 to 5715 every 5 MHz	5490 to 5580 every 5MHz, 5670 to 5705 every 5 MHz	5475 to 5595 every 5MHz, 5655 to 5720 every 5 MHz		30 for 20 MHz and 40MHz, 27 for 10 MHz, 24 for 5 MHz	
Macedonia	5470-5600, 5650-5725	5480 to 5590 every 5MHz, 5660 to 5715 every 5 MHz	5490 to 5580 every 5MHz, 5670 to 5705 every 5 MHz	5475 to 5595 every 5MHz, 5655 to 5720 every 5 MHz	15	30 for 20 MHz and 40MHz, 27 for 10 MHz, 24 for 5 MHz	ETSI
Malaysia	5470-5725	5480 to 5730 every 5MHz	5490 to 5740 every 5MHz	5475 to 5725 every 5MHz	19		None
Malta	5470-5600, 5650-5725	5480 to 5590 every 5MHz, 5660 to 5715 every 5 MHz	5490 to 5580 every 5MHz, 5670 to 5705 every 5 MHz	5475 to 5595 every 5MHz, 5655 to 5720 every 5 MHz	15	30 for 20 MHz and 40MHz, 27 for 10 MHz, 24 for 5 MHz	ETSI
		5480 to 5590 every 5MHz, 5660 to 5715 every 5 MHz	5490 to 5580 every 5MHz, 5670 to 5705 every 5 MHz	5475 to 5595 every 5MHz, 5655 to 5720 every 5 MHz		30 for 20 MHz and 40MHz, 27 for 10 MHz, 24 for 5 MHz	
Mauritius	5470-5725	5480 to 5715 every 5MHz	5490 to 5705 every 5MHz	5475 to 5720 every 5MHz	15	30 for 20 MHz and 40MHz, 27 for 10 MHz, 24 for 5 MHz	ETSI
Mexico	5470-5600, 5650-5725	5495 to 5590 every 5MHz, 5660 to 5705 every 5 MHz	5510 to 5580 every 5MHz, 5670 to 5695 every 5 MHz	5475 to 5595 every 5MHz, 5655 to 5720 every 5 MHz	16	30 for 20 MHz and 40MHz, 27 for 10 MHz, 24 for 5 MHz	FCC
		5480 to 5730 every 5MHz	5490 to 5740 every 5MHz	5475 to 5725 every 5MHz		30 for 20 MHz and 40MHz, 27 for 10 MHz, 24 for 5 MHz	
Moldova	5470-5725	5480 to 5730 every 5MHz	5490 to 5740 every 5MHz	5475 to 5725 every 5MHz	19		None
Netherlands	5470-5600, 5650-5725	5480 to 5590 every 5MHz, 5660 to 5715 every 5 MHz	5490 to 5580 every 5MHz, 5670 to 5705 every 5 MHz	5475 to 5595 every 5MHz, 5655 to 5720 every 5 MHz	15	30 for 20 MHz and 40MHz, 27 for 10 MHz, 24 for 5 MHz	ETSI
		5480 to 5590 every 5MHz, 5660 to 5715 every 5 MHz	5490 to 5580 every 5MHz, 5670 to 5705 every 5 MHz	5475 to 5595 every 5MHz, 5655 to 5720 every 5 MHz		30 for 20 MHz and 40MHz, 27 for 10 MHz, 24 for 5 MHz	
Netherlands Antilles	5470-5600, 5650-5725	5480 to 5590 every 5MHz, 5660 to 5715 every 5 MHz	5490 to 5580 every 5MHz, 5670 to 5705 every 5 MHz	5475 to 5595 every 5MHz, 5655 to 5720 every 5 MHz	15	30 for 20 MHz and 40MHz, 27 for 10 MHz, 24 for 5 MHz	ETSI
Nigeria	5470-5725	5480 to 5715 every 5MHz	5490 to 5705 every 5MHz	5475 to 5720 every 5MHz	15	36	None
Norway	5470-5600, 5650-5725	5480 to 5590 every 5MHz, 5660 to 5715 every 5 MHz	5490 to 5580 every 5MHz, 5670 to 5705 every 5 MHz	5475 to 5595 every 5MHz, 5655 to 5720 every 5 MHz	15	30 for 20 MHz and 40MHz, 27 for 10 MHz, 24 for 5 MHz	ETSI
		5480 to 5590 every 5MHz, 5660 to 5715 every 5 MHz	5490 to 5580 every 5MHz, 5670 to 5705 every 5 MHz	5475 to 5595 every 5MHz, 5655 to 5720 every 5 MHz		30 for 20 MHz and 40MHz, 27 for 10 MHz, 24 for 5 MHz	
Oman	5470-5725	5480 to 5715 every 5MHz	5490 to 5705 every 5MHz	5475 to 5720 every 5MHz	15	30 for 20 MHz and 40MHz, 27 for 10 MHz, 24 for 5 MHz	ETSI
Other	5470-5725	5475 to 5730 every 5MHz	5475 to 5740 every 5MHz	5475 to 5725 every 5MHz	30		None
Peru	5470-5725	5480 to 5715 every 5MHz	5490 to 5705 every 5MHz	5475 to 5720 every 5MHz	16	30	ETSI
Philippines	5470-5725	5480 to 5730 every 5MHz	5490 to 5740 every 5MHz	5475 to 5725 every 5MHz	19	26	None
Poland	5470-5600, 5650-5725	5480 to 5590 every 5MHz, 5660 to 5715 every 5 MHz	5490 to 5580 every 5MHz, 5670 to 5705 every 5 MHz	5475 to 5595 every 5MHz, 5655 to 5720 every 5 MHz	15	30 for 20 MHz and 40MHz, 27 for 10 MHz, 24 for 5 MHz	ETSI
		5480 to 5590 every 5MHz, 5660 to 5715 every 5 MHz	5490 to 5580 every 5MHz, 5670 to 5705 every 5 MHz	5475 to 5595 every 5MHz, 5655 to 5720 every 5 MHz		30 for 20 MHz and 40MHz, 27 for 10 MHz, 24 for 5 MHz	
Portugal	5470-5600, 5650-5725	5480 to 5590 every 5MHz,	5490 to 5580 every 5MHz,	5475 to 5595 every 5MHz,	15	30 for 20 MHz and 40MHz, 27 for 10 MHz,	ETSI

Country	Frequency range	Valid Center Frequency for 20 MHz Band	Valid Center Frequency for 40 MHz Band	Valid Center Frequency for 5/10 MHz Band 3	Conducted Power	EIRP Power	DFS
Puerto Rico	5470-5600, 5650-5725	5660 to 5715 every 5 MHz	5670 to 5705 every 5 MHz	5655 to 5720 every 5 MHz	14	MHz, 24 for 5 MHz	FCC
		5495 to 5590 every 5MHz, 5660 to 5705 every 5 MHz	5510 to 5580 every 5MHz, 5670 to 5695 every 5 MHz	5495 to 5595 every 5MHz, 5655 to 5705 every 5 MHz		30 for 20 MHz and 40MHz, 27 for 10 MHz, 24 for 5 MHz	
Romania	5470-5600, 5650-5725	5480 to 5590 every 5MHz, 5660 to 5715 every 5 MHz	5490 to 5580 every 5MHz, 5670 to 5705 every 5 MHz	5475 to 5595 every 5MHz, 5655 to 5720 every 5 MHz	15	30 for 20 MHz and 40MHz, 27 for 10 MHz, 24 for 5 MHz	ETSI
Russia	5470-5725	5480 to 5730 every 5MHz	5490 to 5740 every 5MHz	5475 to 5725 every 5MHz	19		None
Serbia	5470-5600, 5650-5725	5480 to 5590 every 5MHz, 5660 to 5715 every 5 MHz	5490 to 5580 every 5MHz, 5670 to 5705 every 5 MHz	5475 to 5595 every 5MHz, 5655 to 5720 every 5 MHz	15	30 for 20 MHz and 40MHz, 27 for 10 MHz, 24 for 5 MHz	ETSI
Slovakia	5470-5600, 5650-5725	5480 to 5590 every 5MHz, 5660 to 5715 every 5 MHz	5490 to 5580 every 5MHz, 5670 to 5705 every 5 MHz	5475 to 5595 every 5MHz, 5655 to 5720 every 5 MHz	15	30 for 20 MHz and 40MHz, 27 for 10 MHz, 24 for 5 MHz	ETSI
Slovenia	5470-5600, 5650-5725	5480 to 5590 every 5MHz, 5660 to 5715 every 5 MHz	5490 to 5580 every 5MHz, 5670 to 5705 every 5 MHz	5475 to 5595 every 5MHz, 5655 to 5720 every 5 MHz	15	30 for 20 MHz and 40MHz, 27 for 10 MHz, 24 for 5 MHz	ETSI
South Africa	5470-5725	5480 to 5715 every 5MHz	5490 to 5705 every 5MHz	5475 to 5720 every 5MHz	15	30	
South Korea	5470-5650	5480 to 5640 every 5MHz	NA	5475 to 5645 every 5MHz	16	30	ETSI
Spain	5470-5600, 5650-5725	5480 to 5590 every 5MHz, 5660 to 5715 every 5 MHz	5490 to 5580 every 5MHz, 5670 to 5705 every 5 MHz	5475 to 5595 every 5MHz, 5655 to 5720 every 5 MHz	15	30 for 20 MHz and 40MHz, 27 for 10 MHz, 24 for 5 MHz	ETSI
Sweden	5470-5600, 5650-5725	5480 to 5590 every 5MHz, 5660 to 5715 every 5 MHz	5490 to 5580 every 5MHz, 5670 to 5705 every 5 MHz	5475 to 5595 every 5MHz, 5655 to 5720 every 5 MHz	15	30 for 20 MHz and 40MHz, 27 for 10 MHz, 24 for 5 MHz	ETSI
Switzerland	5470-5600, 5650-5725	5480 to 5590 every 5MHz, 5660 to 5715 every 5 MHz	5490 to 5580 every 5MHz, 5670 to 5705 every 5 MHz	5475 to 5595 every 5MHz, 5655 to 5720 every 5 MHz	15	30 for 20 MHz and 40MHz, 27 for 10 MHz, 24 for 5 MHz	ETSI
Taiwan	5470-5600, 5650-5725	5495 to 5590 every 5MHz, 5660 to 5705 every 5 MHz	5510 to 5580 every 5MHz, 5670 to 5695 every 5 MHz	5495 to 5590 every 5MHz, 5660 to 5705 every 5 MHz	14	30 for 20 MHz and 40MHz, 27 for 10 MHz, 24 for 5 MHz	FCC
Tajikistan	5470-5725	5480 to 5730 every 5MHz	5490 to 5740 every 5MHz	5475 to 5725 every 5MHz	19		None
Thailand	5470-5725	5480 to 5715 every 5MHz	5490 to 5705 every 5MHz	5475 to 5720 every 5MHz	16	30 for 20 MHz and 40MHz, 27 for 10 MHz, 24 for 5 MHz	FCC
Turkey	5470-5725	5480 to 5715 every 5MHz	5490 to 5705 every 5MHz	5475 to 5720 every 5MHz	15	30 for 20 MHz and 40MHz, 27 for 10 MHz, 24 for 5 MHz	ETSI
Turkmenistan	5470-5725	5480 to 5730 every 5MHz	5490 to 5740 every 5MHz	5475 to 5725 every 5MHz	19		None
U.S. Virgin Islands	5470-5600, 5650-5725	5495 to 5590 every 5MHz, 5660 to 5705 every 5 MHz	5510 to 5580 every 5MHz, 5670 to 5695 every 5 MHz	5495 to 5595 every 5MHz, 5655 to 5705 every 5 MHz	14	30 for 20 MHz and 40MHz, 27 for 10 MHz, 24 for 5 MHz	FCC

Country	Frequency range	Valid Center Frequency for 20 MHz Band	Valid Center Frequency for 40 MHz Band	Valid Center Frequency for 5/10 MHz Band 3	Conducted Power	EIRP Power	DFS
Uganda	5470-5725	5480 to 5715 every 5MHz	5490 to 5705 every 5MHz	5475 to 5720 every 5MHz	30	30 for 20 MHz and 40MHz, 27 for 10 MHz, 24 for 5 MHz	FCC
Ukraine	5470-5725	5480 to 5730 every 5MHz	5490 to 5740 every 5MHz	5475 to 5725 every 5MHz	19		
United Kingdom	5470-5600,5650-5725	5480 to 5590 every 5MHz, 5660 to 5715 every 5 MHz	5490 to 5580 every 5MHz, 5670 to 5705 every 5 MHz	5475 to 5595 every 5MHz, 5655 to 5720 every 5 MHz	15	30 for 20 MHz and 40MHz, 27 for 10 MHz, 24 for 5 MHz	ETSI
United States	5470-5600, 5650-5725	5495 to 5590 every 5MHz, 5660 to 5705 every 5 MHz	5510 to 5580 every 5MHz, 5670 to 5695 every 5 MHz	5495 to 5595 every 5MHz, 5655 to 5705 every 5 MHz	14	30 for 20 MHz and 40MHz, 27 for 10 MHz, 24 for 5 MHz	FCC
Uzbekistan	5470-5725	5480 to 5730 every 5MHz	5490 to 5740 every 5MHz	5475 to 5725 every 5MHz	19		None
Venezuela	5470-5725	5480 to 5730 every 5MHz	5490 to 5740 every 5MHz	5475 to 5725 every 5MHz	19	30	None



**Table 187 Regulatory limits - 5.8/5.9 GHz**

Country	Frequency ranges	Valid Center Frequency for 20 MHz Band	Valid Center Frequency for 40 MHz Band	Valid Center Frequency for 5/10 MHz Band <sup>4</sup>	Conducted Power	EIRP Power	DFS
Argentina	5725-5850	5735 to 5840 every 5 MHz	5745 to 5830 every 5 MHz	5730 to 5845 every 5 MHz	23		None
Armenia	5725-5980	5735 to 5970 every 5 MHz	5745 to 5960 every 5 MHz	5730 to 5975 every 5 MHz	23		None
Australia	5725-5850	5740 to 5835 every 5 MHz	5750 to 5825 every 5 MHz	5730 to 5845 every 5 MHz	23	36	None
Azerbaijan	5725-5980	5735 to 5970 every 5 MHz	5745 to 5960 every 5 MHz	5730 to 5975 every 5 MHz	23		None
Bahrain	5725-5850	5735 to 5840 every 5 MHz	5745 to 5830 every 5 MHz	5730 to 5845 every 5 MHz	23	33	ETSI
Bangladesh	5725-5825	5735 to 5840 every 5 MHz	5745 to 5830 every 5 MHz	5730 to 5845 every 5 MHz	30		None
Belarus	5725-5980	5735 to 5970 every 5 MHz	5745 to 5960 every 5 MHz	5730 to 5975 every 5 MHz	23		None
Botswana	5725-5875	5735 to 5865 every 5 MHz	5745 to 5855 every 5 MHz	5730 to 5870 every 5 MHz	23	40	No
Brazil	5725-5850	5740 to 5835 every 5 MHz	5750 to 5825 every 5 MHz	5730 to 5845 every 5 MHz	23	36 for PMP AP. No limit for other modes.	None
Canada	5725-5850	5740 to 5835 every 5 MHz	5750 to 5825 every 5 MHz	5740 to 5835 every 5 MHz	23 for PMP AP PMP, 30 for PTP and SM mode.	36 for PMP AP. No limit for other modes.	None
Chile	5725-5850	5735 to 5840 every 5 MHz	5745 to 5830 every 5 MHz	5730 to 5845 every 5 MHz	23	36	None
China	5725-5850	5740 to 5835 every 5 MHz	5750 to 5825 every 5 MHz	5730 to 5845 every 5 MHz	23	33	None
Colombia	5725-5825	5735 to 5815 every 5 MHz	5745 to 5805 every 5 MHz	5730 to 5820 every 5 MHz	23	36	None
Denmark	5725-5795, 5815-5875	5735 to 5785 every 5 MHz, 5825 to 5865 every 5 MHz	5745 to 5775 every 5 MHz, 5835 to 5855 every 5 MHz	5730 to 5790 every 5 MHz, 5820 to 5870 every 5 MHz	23	36	ETSI
Ecuador	5725-5850	5735 to 5840 every 5 MHz	5745 to 5830 every 5 MHz	5730 to 5845 every 5 MHz	23	53	None
Finland	5725-5795, 5815-5850	5735 to 5785 every 5 MHz, 5825 to 5840 every 5 MHz	5745 to 5775 every 5 MHz,	5730 to 5790 every 5 MHz, 5820 to 5845 every 5 MHz	23	36	ETSI
Georgia	5725-5980	5735 to 5970 every 5 MHz	5745 to 5960 every 5 MHz	5730 to 5975 every 5 MHz	23		None
Germany	5755-5875	5765 to 5865 every 5 MHz	5775 to 5855 every 5 MHz	5730 to 5870 every 5 MHz	23	36	ETSI
Ghana	5725-5825	5740 to 5810 every 5 MHz	5750 to 5800 every 5 MHz	5730 to 5820 every 5 MHz	23	36	FCC
Greece	5725-5795	5735 to 5785 every 5 MHz	5745 to 5775 every 5 MHz	5730 to 5790 every 5 MHz	23	36	ETSI

<sup>4</sup> 5 MHz Channel bandwidth not available for DFS regions/bands.

Country	Frequency ranges	Valid Center Frequency for 20 MHz Band	Valid Center Frequency for 40 MHz Band	Valid Center Frequency for 5/10 MHz Band 4	Conducted Power	EIRP Power	DFS
Guam	5725-5850	5740 to 5835 every 5 MHz	5750 to 5825 every 5 MHz	5740 to 5835 every 5 MHz	23 for PMP AP PMP, 30 for PTP and SM mode.	36 for PMP AP. No limit for other modes.	None
Hong Kong	5725-5850	5740 to 5835 every 5 MHz	5750 to 5825 every 5 MHz	5730 to 5845 every 5 MHz	23	36	None
Iceland	5725-5875	5735 to 5865 every 5 MHz	5745 to 5855 every 5 MHz	5730 to 5870 every 5 MHz	23	36	ETSI
India	5825-5875	5835 to 5865 every 5 MHz	5845 to 5855 every 5 MHz	5830 to 5870 every 5 MHz	23	36	None
Indonesia	5725-5825	5735 to 5815 every 5 MHz	NA	5730 to 5820 every 5 MHz	23	36	None
Ireland	5725-5875	5740 to 5860 every 5 MHz	5750 to 5850 every 5 MHz	5730 to 5870 every 5 MHz	23	33	None
Kazakhstan	5725-5980	5735 to 5970 every 5 MHz	5745 to 5960 every 5 MHz	5730 to 5975 every 5 MHz	23		None
Kenya	5725-5800	5735 to 5790 every 5 MHz	5745 to 5780 every 5 MHz	5730 to 5795 every 5 MHz	23	36	None
Kyrgyzstan	5725-5980	5735 to 5970 every 5 MHz	5745 to 5960 every 5 MHz	5730 to 5975 every 5 MHz	23		None
Liechtenstein	5725-5795, 5815-5875	5735 to 5785 every 5 MHz, 5825 to 5865 every 5 MHz	5745 to 5775 every 5 MHz, 5835 to 5855 every 5 MHz	5730 to 5790 every 5 MHz, 5820 to 5870 every 5 MHz	23	36	ETSI
Malaysia	5725-5875	5740 to 5860 every 5 MHz	5750 to 5850 every 5 MHz	5730 to 5870 every 5 MHz	23	30	None
Mauritius	5725-5850	5735 to 5840 every 5 MHz	NA	5730 to 5845 every 5 MHz	23	36	ETSI
Mexico	5725-5850	5740 to 5835 every 5 MHz	5750 to 5825 every 5 MHz	5730 to 5845 every 5 MHz	23	36	None
Moldova	5725-5980	5735 to 5970 every 5 MHz	5745 to 5960 every 5 MHz	5730 to 5975 every 5 MHz	23		None
New Zealand	5725-5875 for PMP, 5725-5825 for PTP	5735 to 5865 for PMP, 5735 to 5815 every 5 MHz for PTP	5745 to 5855 for PMP, 5745 to 5805 every 5 MHz for PTP	5730 to 5870 for PMP, 5730 to 5820 every 5 MHz for PTP	23	36	No
Nigeria	5725-5850	5740 to 5835 every 5 MHz	5750 to 5825 every 5 MHz	5730 to 5845 every 5 MHz	23		ETSI
Norway	5725-5795, 5815-5850	5735 to 5785 every 5 MHz, 5825 to 5840 every 5 MHz	5745 to 5775 every 5 MHz,	5730 to 5790 every 5 MHz, 5820 to 5845 every 5 MHz	23	36	ETSI
Oman	5725-5850	5735 to 5840 every 5 MHz	5745 to 5830 every 5 MHz	5730 to 5845 every 5 MHz	23	33	ETSI
Other	5725-5980	5735 to 5970 every 5 MHz	5745 to 5960 every 5 MHz	5730 to 5975 every 5 MHz	30		None
Pakistan	5725-5875	5735 to 5865 every 5 MHz	5745 to 5855 every 5 MHz	5730 to 5870 every 5 MHz	30	53	None
Peru	5725-5850	5735 to 5840 every 5 MHz	5745 to 5830 every 5 MHz	5730 to 5845 every 5 MHz	23	36	None

Country	Frequency ranges	Valid Center Frequency for 20 MHz Band	Valid Center Frequency for 40 MHz Band	Valid Center Frequency for 5/10 MHz Band 4	Conducted Power	EIRP Power	DFS
Philippines	5725-5825	5740 to 5810 every 5 MHz	5750 to 5800 every 5 MHz	5730 to 5820 every 5 MHz	23	30	No
Portugal	5725-5875	5735 to 5865 every 5 MHz	5745 to 5855 every 5 MHz	5730 to 5870 every 5 MHz	23	36	ETSI
Puerto Rico	5725-5850	5740 to 5835 every 5 MHz	5750 to 5825 every 5 MHz	5740 to 5835 every 5 MHz	23 for PMP AP PMP, 30 for PTP and SM mode.	36 for PMP AP. No limit for other modes.	None
Russia	5725-5980	5735 to 5970 every 5 MHz	5745 to 5960 every 5 MHz	5730 to 5975 every 5 MHz	23		None
Serbia	5725-5875	5735 to 5865 every 5 MHz	5745 to 5855 every 5 MHz	5730 to 5870 every 5 MHz	23	36	ETSI
Seychelles	5725-5850	5740 to 5835 every 5 MHz	5750 to 5825 every 5 MHz	5730 to 5845 every 5 MHz	23	36	ETSI
Singapore	5725-5850	5740 to 5835 every 5 MHz	5750 to 5825 every 5 MHz	5730 to 5845 every 5 MHz	23	30	ETSI
South Africa	5725-5850	5735 to 5840 every 5 MHz	5745 to 5830 every 5 MHz	5730 to 5845 every 5 MHz	30	36	No
South Korea	5725-5825	5740 to 5810 every 5 MHz	5750 to 5800 every 5 MHz	5730 to 5820 every 5 MHz	23	30	No
Spain	5725-5795, 5815-5855	5735 to 5785 every 5 MHz, 5825 to 5845 every 5 MHz	5745 to 5775 every 5 MHz, 5835 to 5835 every 5 MHz	5730 to 5790 every 5 MHz, 5820 to 5850 every 5 MHz	23	36	ETSI
Switzerland	5725-5795, 5815-5875	5735 to 5785 every 5 MHz, 5825 to 5865 every 5 MHz	5745 to 5775 every 5 MHz, 5835 to 5855 every 5 MHz	5730 to 5790 every 5 MHz, 5820 to 5870 every 5 MHz	23	36	ETSI
Taiwan	5725-5850	5740 to 5835 every 5 MHz	5750 to 5825 every 5 MHz	5730 to 5845 every 5 MHz	23 for PMP AP PMP, 30 for PTP and SM mode.	36 for PMP AP. No limit for other modes.	None
Tajikistan	5725-5980	5735 to 5970 every 5 MHz	5745 to 5960 every 5 MHz	5730 to 5975 every 5 MHz	23		None
Thailand	5725-5850	5740 to 5835 every 5 MHz	5750 to 5825 every 5 MHz	5730 to 5845 every 5 MHz	23	30	None
Turkmenistan	5725-5980	5735 to 5970 every 5 MHz	5745 to 5960 every 5 MHz	5730 to 5975 every 5 MHz	23		None
U.S. Virgin Islands	5725-5850	5740 to 5835 every 5 MHz	5750 to 5825 every 5 MHz	5740 to 5835 every 5 MHz	23 for PMP AP PMP, 30 for PTP and SM mode.	36 for PMP AP. No limit for other modes.	None
Uganda	5725-5825	5735 to 5815 every 5 MHz	5745 to 5805 every 5 MHz	5730 to 5820 every 5 MHz	30	32 dBm + 2 + (Configured Antenna Gain/3)	No
Ukraine	5725-5980	5735 to 5970 every 5 MHz	5745 to 5960 every 5 MHz	5730 to 5975 every 5 MHz	23		None
United Kingdom	5725-5850	5735 to 5840 every 5 MHz	5745 to 5830 every 5 MHz	5730 to 5845 every 5 MHz	23	36	ETSI
United States	5725-5850	5740 to 5835 every 5 MHz	5750 to 5825 every 5 MHz	5740 to 5835 every 5 MHz	23 for PMP AP PMP, 30 for PTP and SM mode.	36 for PMP AP. No limit for other modes.	None
Uzbekistan	5725-5980	5735 to 5970 every 5 MHz	5745 to 5960 every 5 MHz	5730 to 5975 every 5 MHz	23		None

---

Country	Frequency ranges	Valid Center Frequency for 20 MHz Band	Valid Center Frequency for 40 MHz Band	Valid Center Frequency for 5/10 MHz Band 4	Conducted Power	EIRP Power	DFS
Venezuela	5725-5850	5735 to 5840 every 5 MHz	5745 to 5830 every 5 MHz	5730 to 5845 every 5 MHz	23	36	None
Vietnam	5725-5850	5735 to 5840 every 5 MHz	5745 to 5830 every 5 MHz	5730 to 5845 every 5 MHz	23	30	None

---

**Table 188** Regulatory limits - 2.4 GHz

Country	Frequency ranges	Valid Center Frequency for 20 MHz Band	Valid Center Frequency for 40 MHz Band	Valid Center Frequency for 5/10 MHz Band	Conducted Power	EIRP Power
Angola	2400-2500	2412-2472 every 5MHz	2422-2462 every 5MHz	2407-2477 every 5MHz	27	36
Armenia	2400-2500	2412-2472 every 5MHz	2422-2462 every 5MHz	2407-2477 every 5MHz		
Argentina	2400-2500	2412-2472 every 5MHz	2422-2462 every 5MHz	2407-2477 every 5MHz	27	36
Australia	2400-2500	2412-2462 every 5MHz	2422-2452 every 5MHz	2407-2477 every 5MHz		36
Austria	2400-2500	2412-2472 every 5MHz	2422-2462 every 5MHz	2407-2477 every 5MHz		
Azerbaijan	2400-2500	2412-2472 every 5MHz	2422-2462 every 5MHz	2407-2477 every 5MHz		
Bahrain	2400-2500	2412-2472 every 5MHz	2422-2462 every 5MHz	2407-2477 every 5MHz		36
Bangladesh	2400-2483.5	2412-2472 every 5MHz	2422-2462 every 5MHz	2407-2477 every 5MHz	30	36
Brazil	2400-2500	2412-2472 every 5MHz	2422-2462 every 5MHz	2407-2477 every 5MHz	23	36
Belarus	2400-2500	2412-2472 every 5MHz	2422-2462 every 5MHz	2407-2477 every 5MHz		
Belgium	2400-2500	2412-2472 every 5MHz	2422-2462 every 5MHz	2407-2477 every 5MHz		
Bosnia	2400-2500	2412-2472 every 5MHz	2422-2462 every 5MHz	2407-2477 every 5MHz		
Botswana	2400-2500	2412-2472 every 5MHz	2422-2462 every 5MHz	2407-2477 every 5MHz	27	36
Bulgaria	2400-2500	2412-2472 every 5MHz	2422-2462 every 5MHz	2407-2477 every 5MHz		
Canada	2400-2500	2412-2462 every 5MHz	2427-2452 every 5MHz	2407-2467 every 5MHz	27 for 20M Freq Band, 21 for 40M Freq band, 27 for 10M and 5M Freq Band	36 for PMP AP. 30 dBm + 6 + ((Configured Antenna Gain - 6)/3) for other modes.
Chile	2400-2500	2412-2472 every 5MHz	2422-2462 every 5MHz	2407-2477 every 5MHz	27	36
China	2400-2500	2412-2472 every 5MHz	2422-2462 every 5MHz	2407-2477 every 5MHz	27	36
Colombia	2400-2500	2412-2472 every 5MHz	2422-2462 every 5MHz	2407-2477 every 5MHz	27	36
Congo-Kinshasa	2400-2500	2412-2472 every 5MHz	2422-2462 every 5MHz	2407-2477 every 5MHz	27	36
Croatia	2400-2500	2412-2472 every 5MHz	2422-2462 every 5MHz	2407-2477 every 5MHz		
Cyprus	2400-2500	2412-2472 every 5MHz	2422-2462 every 5MHz	2407-2477 every 5MHz		
Czech Republic	2400-2500	2412-2472 every 5MHz	2422-2462 every 5MHz	2407-2477 every 5MHz		
Denmark	2400-2500	2412-2472 every 5MHz	2422-2462 every 5MHz	2407-2477 every 5MHz		
Ecuador	2400-2500	2412-2472 every 5MHz	2422-2462 every 5MHz	2407-2477 every 5MHz		36
Finland	2400-2500	2412-2472 every 5MHz	2422-2462 every 5MHz	2407-2477 every 5MHz		

Country	Frequency ranges	Valid Center Frequency for 20 MHz Band	Valid Center Frequency for 40 MHz Band	Valid Center Frequency for 5/10 MHz Band	Conducted Power	EIRP Power
France	2400-2500	2412-2472 every 5MHz	2422-2462 every 5MHz	2407-2477 every 5MHz		
Georgia	2400-2500	2412-2472 every 5MHz	2422-2462 every 5MHz	2407-2477 every 5MHz		
Germany	2400-2500	2412-2472 every 5MHz	2422-2462 every 5MHz	2407-2477 every 5MHz		
Ghana	2400-2500	2412-2472 every 5MHz	2422-2462 every 5MHz	2407-2477 every 5MHz	23	36
Greece	2400-2500	2412-2472 every 5MHz	2422-2462 every 5MHz	2407-2477 every 5MHz		
Guam	2400-2500	2412-2462 every 5MHz	2427-2452 every 5MHz	2407-2467 every 5MHz		36 for PMP AP. 30 dBm + 6 + ((Configured Antenna Gain - 6)/3) for other modes.
Herzegovina	2400-2500	2412-2472 every 5MHz	2422-2462 every 5MHz	2407-2477 every 5MHz		20
Hong Kong	2400-2500	2412-2472 every 5MHz	2422-2462 every 5MHz	2407-2477 every 5MHz		36
Hungary	2400-2500	2412-2472 every 5MHz	2422-2462 every 5MHz	2407-2477 every 5MHz		
Indonesia	2400-2500	2412-2472 every 5MHz	2422-2462 every 5MHz	2407-2477 every 5MHz	23	36
India	2400-2500	2412-2472 every 5MHz	2422-2462 every 5MHz	2407-2477 every 5MHz		36
Ireland	2400-2500	2412-2472 every 5MHz	2422-2462 every 5MHz	2407-2477 every 5MHz		
Israel	2400-2500	2412-2472 every 5MHz	2422-2462 every 5MHz	2407-2477 every 5MHz		
Italy	2400-2500	2412-2472 every 5MHz	2422-2462 every 5MHz	2407-2477 every 5MHz		
Kenya	2400-2500	2412-2472 every 5MHz	2422-2462 every 5MHz	2407-2477 every 5MHz	23	36
Kyrgyzstan	2400-2500	2412-2472 every 5MHz	2422-2462 every 5MHz	2407-2477 every 5MHz	27	
Latvia	2400-2500	2412-2472 every 5MHz	2422-2462 every 5MHz	2407-2477 every 5MHz		
Liechtenstein	2400-2500	2412-2472 every 5MHz	2422-2462 every 5MHz	2407-2477 every 5MHz		
Lithuania	2400-2500	2412-2472 every 5MHz	2422-2462 every 5MHz	2407-2477 every 5MHz		
Luxembourg	2400-2500	2412-2472 every 5MHz	2422-2462 every 5MHz	2407-2477 every 5MHz		
South Korea	2400-2500	2412-2472 every 5MHz	2422-2462 every 5MHz	2407-2477 every 5MHz		36
Kazakhstan	2400-2500	2412-2472 every 5MHz	2422-2462 every 5MHz	2407-2477 every 5MHz		
Macedonia	2400-2500	2412-2472 every 5MHz	2422-2462 every 5MHz	2407-2477 every 5MHz		
Malta	2400-2500	2412-2472 every 5MHz	2422-2462 every 5MHz	2407-2477 every 5MHz		
Moldova	2400-2500	2412-2472 every 5MHz	2422-2462 every 5MHz	2407-2477 every 5MHz	27	
Mexico	2400-2500	2412-2472 every 5MHz	2422-2462 every 5MHz	2407-2477 every 5MHz	27	36

Country	Frequency ranges	Valid Center Frequency for 20 MHz Band	Valid Center Frequency for 40 MHz Band	Valid Center Frequency for 5/10 MHz Band	Conducted Power	EIRP Power
Malaysia	2400-2500	2412-2472 every 5MHz	2422-2462 every 5MHz	2407-2477 every 5MHz		36
Mauritius	2400-2500	2412-2472 every 5MHz	2422-2462 every 5MHz	2407-2477 every 5MHz		
Mozambique	2400-2500	2412-2472 every 5MHz	2422-2462 every 5MHz	2407-2477 every 5MHz	27	36
Myanmar	2400-2500	2412-2487 every 5MHz	2422-2477 every 5MHz	2407-2492 every 5MHz	27	36
Namibia	2400-2500	2412-2472 every 5MHz	2422-2462 every 5MHz	2407-2477 every 5MHz	27	36
Netherlands	2400-2500	2412-2472 every 5MHz	2422-2462 every 5MHz	2407-2477 every 5MHz		
New Zealand	2400-2500	2412-2472 every 5MHz	2422-2462 every 5MHz	2407-2477 every 5MHz	27	36
Nigeria	2400-2500	2412-2472 every 5MHz	2422-2462 every 5MHz	2407-2477 every 5MHz	27	36
Norway	2400-2500	2412-2472 every 5MHz	2422-2462 every 5MHz	2407-2477 every 5MHz		
Oman	2400-2500	2412-2472 every 5MHz	2422-2462 every 5MHz	2407-2477 every 5MHz		
Other	2400-2500	2412-2472 every 5MHz	2422-2462 every 5MHz	2407-2477 every 5MHz	30	
Peru	2400-2500	2412-2472 every 5MHz	2422-2462 every 5MHz	2407-2477 every 5MHz	27	36
Philippines	2400-2500	2412-2472 every 5MHz	2422-2462 every 5MHz	2407-2477 every 5MHz	27	36
Poland	2400-2500	2412-2472 every 5MHz	2422-2462 every 5MHz	2407-2477 every 5MHz		
Portugal	2400-2500	2412-2472 every 5MHz	2422-2462 every 5MHz	2407-2477 every 5MHz		
Puerto Rico	2400-2500	2412-2462 every 5MHz	2427-2452 every 5MHz	2407-2467 every 5MHz	27 for 20M Freq Band, 21 for 40M Freq band, 27 for 10M and 5M Freq Band	36 for PMP AP. 30 dBm + 6 + ((Configured Antenna Gain - 6)/3) for other modes.
Romania	2400-2500	2412-2472 every 5MHz	2422-2462 every 5MHz	2407-2477 every 5MHz		
Russia	2400-2500	2412-2472 every 5MHz	2422-2462 every 5MHz	2407-2477 every 5MHz	27	
Serbia	2400-2500	2412-2472 every 5MHz	2422-2462 every 5MHz	2407-2477 every 5MHz		
Seychelles	2400-2500	2412-2472 every 5MHz	2422-2462 every 5MHz	2407-2477 every 5MHz	27	36
Singapore	2400-2500	2412-2472 every 5MHz	2422-2462 every 5MHz	2407-2477 every 5MHz	27	36
Slovakia	2400-2500	2412-2472 every 5MHz	2422-2462 every 5MHz	2407-2477 every 5MHz		

Country	Frequency ranges	Valid Center Frequency for 20 MHz Band	Valid Center Frequency for 40 MHz Band	Valid Center Frequency for 5/10 MHz Band	Conducted Power	EIRP Power
Slovenia	2400-2500	2412-2472 every 5MHz	2422-2462 every 5MHz	2407-2477 every 5MHz		
South Africa	2400-2500	2412-2472 every 5MHz	2422-2462 every 5MHz	2407-2477 every 5MHz	27	36
South Korea	2400-2500	2412-2472 every 5MHz	2422-2462 every 5MHz	2407-2477 every 5MHz	27	36
Spain	2400-2500	2412-2472 every 5MHz	2422-2462 every 5MHz	2407-2477 every 5MHz		
Swaziland	2400-2500	2412-2472 every 5MHz	2422-2462 every 5MHz	2407-2477 every 5MHz	27	36
Sweden	2400-2500	2412-2472 every 5MHz	2422-2462 every 5MHz	2407-2477 every 5MHz		
Switzerland	2400-2500	2412-2472 every 5MHz	2422-2462 every 5MHz	2407-2477 every 5MHz		
Taiwan	2400-2500	2412-2472 every 5MHz	2422-2462 every 5MHz	2407-2477 every 5MHz		36
Tanzania	2400-2500	2412-2472 every 5MHz	2422-2462 every 5MHz	2407-2477 every 5MHz	27	36
Thailand	2400-2500	2412-2472 every 5MHz	2422-2462 every 5MHz	2407-2477 every 5MHz	27	20
Tajikistan	2400-2500	2412-2472 every 5MHz	2422-2462 every 5MHz	2407-2477 every 5MHz	27	
Turkey	2400-2500	2412-2472 every 5MHz	2422-2462 every 5MHz	2407-2477 every 5MHz		
Turkmenistan	2400-2500	2412-2472 every 5MHz	2422-2462 every 5MHz	2407-2477 every 5MHz	27	
Uganda	2400-2500	2412-2472 every 5MHz	2422-2462 every 5MHz	2407-2477 every 5MHz	30	
Ukraine	2400-2500	2412-2472 every 5MHz	2422-2462 every 5MHz	2407-2477 every 5MHz	27	
United Kingdom	2400-2500	2412-2472 every 5MHz	2422-2462 every 5MHz	2407-2477 every 5MHz		
United States	2400-2500	2412-2462 every 5MHz	2427-2452 every 5MHz	2407-2467 every 5MHz	27 for 20M Freq Band , 21 for 40M Freq band, 27 for 10M and 5M Freq Band	36 for PMP AP. 30 dBm + 6 + ((Configured Antenna Gain - 6)/3) for other modes.
U.S. Virgin Islands	2400-2500	2412-2462 every 5MHz	2427-2452 every 5MHz	2407-2467 every 5MHz	27 for 20M Freq band, 21 for 40M Freq band, 27 for 10M and 5M Freq Band	36 for PMP AP. 30 dBm + 6 + ((Configured Antenna Gain - 6)/3) for other modes.
Uzbekistan	2400-2500	2412-2472 every 5MHz	2422-2462 every 5MHz	2407-2477 every 5MHz	27	
Venezuela	2400-2500	2412-2472 every 5MHz	2422-2462 every 5MHz	2407-2477 every 5MHz	27	36



Country	Frequency ranges	Valid Center Frequency for 20 MHz Band	Valid Center Frequency for 40 MHz Band	Valid Center Frequency for 5/10 MHz Band	Conducted Power	EIRP Power
Vietnam	2400-2500	2412-2472 every 5MHz	2422-2462 every 5MHz	2407-2477 every 5MHz	27	36
Zambia	2400-2500	2412-2472 every 5MHz	2422-2462 every 5MHz	2407-2477 every 5MHz	27	36
CIS Countries	2400-2500	2412-2472 every 5MHz	2422-2462 every 5MHz	2407-2477 every 5MHz	27	36

**Table 189** Regulatory limits - 2.5 GHz

Country	Frequency ranges	Valid Center Frequency for 20 MHz Band	Valid Center Frequency for 40 MHz Band	Valid Center Frequency for 5/10 MHz Band	Conducted Power	EIRP Power
Brazil	2500-2690	2510-2680 every 5MHz	2520-2670 every 5MHz	2505-2685 every 5MHz	27	

## Notifications

This section contains notifications of compliance with the radio regulations that are enforced in various regions.

### 2.4 GHz, 5.4 GHz REGULATORY COMPLIANCE

The ePMP complies with the regulations that are enforced in the USA, Canada and Europe. The relevant notifications are specified in this section.

#### 2.4 GHz, 5.1 GHz, 5.4 GHz FCC and IC notification

U.S. Federal Communication Commission (FCC) and Industry Canada (IC) Notification.

This device complies with part 15.407 of the US FCC Rules and Regulations and with RSS-210 Issue 8 of Industry Canada. Operation is subject to the following two conditions: (1) This device may not cause harmful interference, and (2) This device must accept any interference received, including interference that may cause undesired operation. In Canada, users must be cautioned to take note that high power radars are allocated as primary users (meaning they have priority) of 5250 – 5350 MHz and 5470 – 5725 MHz and these radars could cause interference and/or damage to license-exempt local area networks (LELAN). To comply with FCC/IC RF exposure limits for general population or uncontrolled exposure, the antenna(s) used for the ePMP transmitter must be installed at a separation distance specified in [Table 141](#) through [Table 185](#).

For the connectorized version of the product and in order to reduce potential radio interference to other users, the antenna type and its gain must be so chosen that the equivalent isotropically radiated power (EIRP) is not more than that permitted by the regulations. The transmitted power must be reduced to achieve this requirement.

This equipment has been tested and found to comply with the limits for a Class B digital device, pursuant to Part 15 of the US FCC Rules and with RSS-210 of Industry Canada. These limits are designed to provide reasonable protection against harmful interference in a residential installation. This equipment generates, uses, and can radiate radio-frequency energy and, if not installed and used in accordance with these instructions, may cause harmful interference to radio communications. If this equipment does cause harmful interference to radio or television reception, which can be determined by turning the equipment on and off, the user is encouraged to correct the interference by one or more of the following measures:

- Increase the separation between the affected equipment and the unit;
- Connect the affected equipment to a power outlet on a different circuit from that which the receiver is connected to;
- Consult the dealer and/or experienced radio/TV technician for help.

FCC IDs and Industry Canada Certification Numbers are reproduced on the product label ([Figure 90](#) and [Figure 91](#)).

### End Product Labeling

The ePMP Module is labeled with its own FCC ID and IC Certification Number. If the FCC ID and IC Certification Number are not visible when the module is installed inside another device, then the outside of the device into which the module is installed must also display a label referring to the enclosed module. In that case, the final end product must be labeled in a visible area with the following:

**Table 190** ePMP 2000 Product labeling





Region	Label
Access Point (AP)	“Contains Transmitter Module FCC ID: Z8H89FT0020” or “Contains FCC ID: Z8H89FT0020”

**Table 191** ePMP 1000 Product labeling

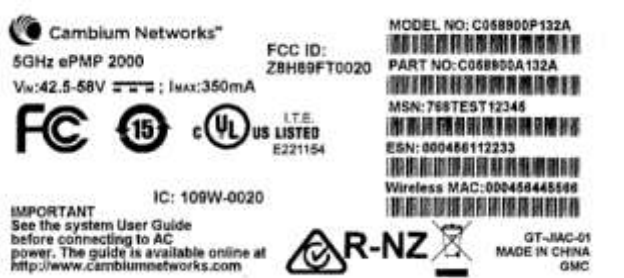
Region	Label
Access Point (AP)	“Contains Transmitter Module FCC ID: Z8H89FT0006” or “Contains FCC ID: Z8H89FT0006”
Subscriber Module (SM)	“Contains Transmitter Module FCC ID: Z8H89FT0005” or “Contains FCC ID: Z8H89FT0005”
Access Point (AP) / Subscriber Module (SM)	“Contains Transmitter Module FCC ID: Z8H89FT0015” or “Contains FCC ID: Z8H89FT0015”
Access Point (AP) / Subscriber Module (SM)	“Contains Transmitter Module FCC ID: Z8H89FT0019” or “Contains FCC ID: Z8H89FT0019”



**Figure 93** FCC and IC certifications on 5 GHz product labels



  
MODEL NO: C058900P112A  
  
PART NO: C058900A112A  
  
MSN: 6069NS006U  
  
ESN: 0A003EA005B3  
FCC ID: Z8H89FT0006  
IC: 109W-0006



IMPORTANT See the System User Guide before connecting to AC power. The guide is available online at <http://www.cambiumnetworks.com>





MADE IN CHINA

 I.T.E. LISTED E221154 

$V_{IN}$ : 22V-56V ;  $I_{MAX}$ : 500mA



CAUTION Class 2 only

 

  
MODEL NO: C058900P122A  
  
PART NO: C058900A122A  
  
MSN: 6069NS006U  
  
ESN: 0A003EA005B3  
FCC ID: Z8H89FT0005  
IC: 109W-0005



IMPORTANT See the System User Guide before connecting to AC power. The guide is available online at <http://www.cambiumnetworks.com>





MADE IN CHINA

 I.T.E. LISTED E221154 

$V_{IN}$ : 22V-56V ;  $I_{MAX}$ : 500mA



CAUTION Class 2 only

 

  
MODEL NO: C058900P132A  
  
PART NO: C058900C132A  
  
MSN: 6069NS006U  
  
ESN: 0A003EA005B3  
FCC ID: Z8H89FT0005  
IC: 109W-0005



IMPORTANT See the System User Guide before connecting to AC power. The guide is available online at <http://www.cambiumnetworks.com>

MADE IN CHINA

 I.T.E. LISTED E221154 

$V_{IN}$ : 22V-56V ;  $I_{MAX}$ : 500mA

CAUTION Class 2 only

PMN : 5GHz Force 180  
 VIN : 14-30V  ; I<sub>MAX</sub> : 500mA  
 Contains FCC ID : Z8H89FT0015  
 IC : 109W-0015  
 FVIN : R2.4.2

**IMPORTANT**  
 See the System User Guide  
 before connecting to AC  
 power. The guide is available online at  
<http://www.cambiumnetworks.com>

MODEL NO / HVIN: C058900P072A  
  
 PART NO: C058900C072A  
  
 MSN: 6068RC00050  
  
 ESN: 000456F80844  
  
 Wireless MAC: 000456F80845  







MADE IN XXXXX 24600001391A R01 XX XX





**Cambium Networks™**  
 Ashburton, TQ13 7UP, UK





5GHz Force 190  
 VIN : 14-30V  ; I<sub>MAX</sub> : 500mA  
 Contains FCC ID: Z8H89FT0031  
 IC: 109W-0031

**IMPORTANT**  
 See the System User Guide  
 before connecting to AC  
 power. The guide is available online at  
<http://www.cambiumnetworks.com>



I.T.E.  
**US LISTED**  
 E221154

JT-SZNC-01  
 MADE IN XXXXX

<p>MODEL NO: <u>C050900P261A</u></p> 	<p>Serial No(MSN): <u>7688RE0001XX</u></p> 
<p>PART NO: <u>C050900C261A</u></p> 	<p>MAC(ESN): <u>000456XXXXXX</u></p> 
<p>Wireless MAC: <u>000456XXXXXX</u></p> 	



ePMP 5 GHz Force 200AR5-25 High Gain Radio (ROW) (EU cord) MADE IN CHINA

PMN : 5GHz Force 200  
VIN : 14-30V --- ; I<sub>MAX</sub> : 500mA  
Contains FCC ID : Z8H89FT0015  
IC: 109W-0015  
FVIN : R2.4.2



**IMPORTANT**  
See the System User Guide  
before connecting to AC  
power. The guide is available online at  
<http://www.cambiumnetworks.com>

MADE IN XXXXX  
24600001390A R01 XX XX

MODEL NO / HVIN: C058900P062A



PART NO: C058900C062A



MSN: 6068RE00050



ESN: 000456F80844



Wireless MAC: 000456F80845



Figure 94 FCC and IC certifications on 2.4 GHz product labels





Wherever necessary, the end user is responsible for obtaining any National licenses required to operate this product and these must be obtained before using the product in any particular country. Contact the appropriate national administrations for details on the conditions of use for the bands in question and any exceptions that might apply.

### 5.4 GHz European Union notification

The ePMP product is a two-way radio transceiver suitable for use in Broadband Wireless Access System (WAS), Radio Local Area Network (RLAN), or Fixed Wireless Access (FWA) systems. It is a Class 1 device and uses operating frequencies that are harmonized throughout the EU member states. The operator is responsible for obtaining any national licenses required to operate this product and these must be obtained before using the product in any particular country.

Hereby, Cambium Networks declares that the ePMP product complies with the essential requirements and other relevant provisions of Directive 1999/5/EC. The declaration of conformity may be consulted at the support website.

The European R&TTE directive 1999/5/EC Certification Number is reproduced on the product label (Figure 92).

Figure 95 European Union certification on 5.4 GHz product label

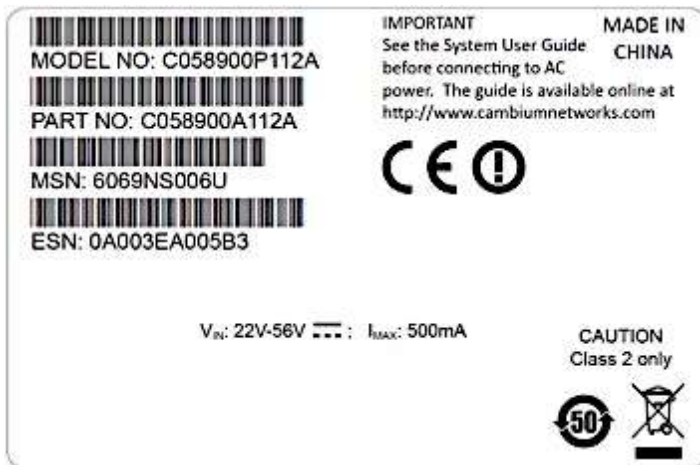

### 5.8 GHz REGULATORY COMPLIANCE

This system has achieved Type Approval in various countries around the world. This means that the system has been tested against various local technical regulations and found to comply. The frequency band in which the system operates is “license exempt” and the system is allowed to be used provided it does not cause interference. The licensing authority does not guaranteed protection against interference from other products and installations.



For the connectorized version of the product and in order to reduce potential radio interference to other users, the antenna type and its gain should be so chosen that the Effective Isotropically Radiated Power (EIRP) is not more than that permitted for successful communication.

### ***U.S. Federal Communication Commission (FCC)***

This device complies with part 15 of the US FCC Rules. Operation is subject to the following two conditions: (1) This device may not cause harmful interference, and (2) This device must accept any interference received, including interference that may cause undesired operation.

This equipment has been tested and found to comply with the limits for a Class B digital device, pursuant to Part 15 of the US FCC Rules. These limits are designed to provide reasonable protection against harmful interference in a residential installation. This equipment generates, uses, and can radiate radio-frequency energy and, if not installed and used in accordance with these instructions, may cause harmful interference to radio communications. If this equipment does cause harmful interference to radio or television reception, which can be determined by turning the equipment on and off, the user is encouraged to correct the interference by one or more of the following measures:

- Increase the separation between the affected equipment and the unit;
- Connect the affected equipment to a power outlet on a different circuit from that which the receiver is connected to;
- Consult the dealer and/or experienced radio/TV technician for help.

### ***Industry Canada (IC)***

This Class B digital apparatus complies with Canadian ICES-003.

Cet appareil numérique de la classe B conforme à la norme NMB-003 du Canada.

RSS-GEN issue 3 (7.1.3) Licence-Exempt Radio Apparatus:

This device complies with Industry Canada license-exempt RSS standard(s). Operation is subject to the following two conditions: (1) this device may not cause interference, and (2) this device must accept any interference, including interference that may cause undesired operation of the device.

*Le présent appareil est conforme aux CNR d'Industrie Canada applicables aux appareils radio exempts de licence. L'exploitation est autorisée aux deux conditions suivantes : (1) l'appareil ne doit pas produire de brouillage, et (2) l'utilisateur de l'appareil doit accepter tout brouillage radioélectrique subi, même si le brouillage est susceptible d'en compromettre le fonctionnement.*

In Canada, high power radars are allocated as primary users (meaning they have priority) of the 5650 – 5850 MHz spectrum. These radars could cause interference or damage to license-exempt local area network (LE-LAN) devices.

### ***Product labels***

FCC IDs and Industry Canada Certification Numbers are reproduced on the product label (**Figure 93**).

Figure 96 FCC and IC certifications on 5.8 GHz product label





Wherever necessary, the end user is responsible for obtaining any National licenses required to operate this product and these must be obtained before using the product in any particular country. Contact the appropriate national administrations for details on the conditions of use for the bands in question and any exceptions that might apply.

### 5.8 GHz European Union notification

The ePMP is a Class 2 device as it operates on frequencies that are not harmonized across the EU. Currently the product may only be operated in the UK, Eire (IRL), Germany, Norway and Denmark. However, the regulatory situation in Europe is changing and the radio spectrum may become available in other countries in future. See [www.ero.dk](http://www.ero.dk) for further information. The operator is responsible for obtaining any national licenses required to operate this product and these must be obtained before using the product in any particular country.



Caution

This equipment operates as a secondary application, so it has no rights against harmful interference, even if generated by similar equipment, and must not cause harmful interference on systems operating as primary applications.

Hereby, Cambium Networks declares that the ePMP product complies with the essential requirements and other relevant provisions of Directive 1999/5/EC. The declaration of conformity may be consulted at the support website.

The European R&TTE directive 1999/5/EC Certification Number is reproduced on the product label ([Figure 94](#)).

**Figure 97** European Union certification on 5.8 GHz product label

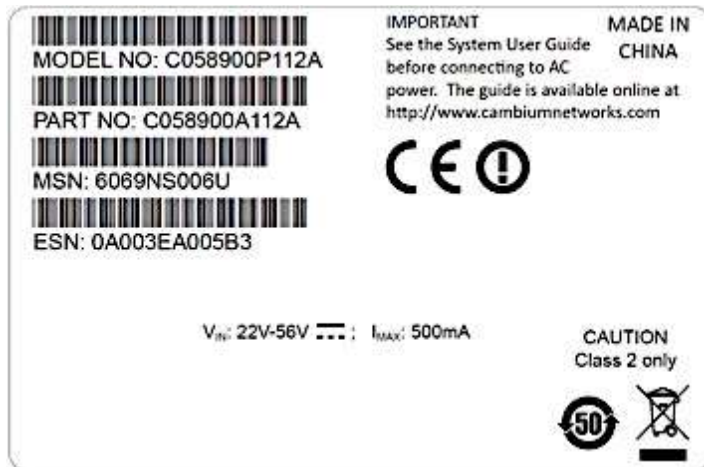

### 5.8 GHz operation in the UK

The ePMP connectorized product has been notified for operation in the UK, and when operated in accordance with instructions for use it is compliant with UK Interface Requirement IR2007. For UK use, installations must conform to the requirements of IR2007 in terms of EIRP spectral density against elevation profile above the local horizon in order to protect Fixed Satellite Services. UK Interface Requirement IR2007 specifies that radiolocation services shall be protected by a Dynamic Frequency Selection (DFS) mechanism to prevent co-channel operation in the presence of radar signals.

### THAILAND NOTIFICATION

เครื่องโทรคมนาคมและอุปกรณ์นี้  
 มีความสอดคล้องตามข้อกำหนดของ กทช.

This telecommunication equipment conforms to the requirements of the National Telecommunications Commission.

## Data throughput tables

This section contains tables to support calculation of the data rate capacity that can be provided by ePMP configurations, as follows:

- See [Data throughput capacity](#) on page 477

### DATA THROUGHPUT CAPACITY

The data throughput rates (Mbps) achieved with an AP/SM pair and the link distance (range) is 0 km as shown in [Table 189](#), [Table 190](#), [Table 191](#), [Table 192](#).

**Table 192** Throughput for ePMP (Flexible Ratio)

MCS	Spatial Streams	Mod. Type	Coding Rate	5 MHz		10 MHz		20 MHz		40 MHz	
				DL	UL	DL	UL	DL	UL	DL	UL
MCS 15	2	64-QAM	5/6	23	20.4	48.4	48.4	95.6	88	202	135
MCS 14	2	64-QAM	3/4	20.8	20.2	43.6	44.2	88	83.4	182	128
MCS 13	2	64-QAM	2/3	18.6	18.8	38.7	38.7	79.3	76.1	163	116
MCS 12	2	16-QAM	3/4	13.7	13.7	29.1	28.7	59.6	58.1	123	61.7
MCS 11	2	16-QAM	1/2	9.27	9.37	19.3	19.1	39.8	38.7	82.2	61.9
MCS 10	2	QPSK	3/4	7.06	6.9	14.7	14.5	30	29.1	62.1	57.4
MCS 9	2	QPSK	1/2	4.85	4.5	9.64	9.59	20.1	19.4	41.6	41.1
MCS 7	1	64-QAM	5/6	11.5	11.6	24.4	24.3	49.7	48.4	103	61.8
MCS 6	1	64-QAM	3/4	10.7	10.5	22	21.8	44.6	43.6	92.1	61.6
MCS 5	1	64-QAM	2/3	9.3	9.37	19.3	19.3	39.9	38.7	82.1	61.6
MCS 4	1	16-QAM	3/4	7.08	6.69	14.7	14.5	30	29.1	61.9	57.6
MCS 3	1	16-QAM	1/2	4.85	4.56	9.67	9.64	20.1	19.4	41.5	41.2
MCS 2	1	QPSK	3/4	3.54	3.37	7.35	7.18	15	14.4	31	30.8
MCS 1	1	QPSK	1/2	2.56	2.25	5.01	4.75	10.2	9.67	20.8	20.5

**Table 193** Throughput for ePMP (75/25 Ratio)

MCS	Spatial Streams	Mod. Type	Coding Rate	5 MHz		10 MHz		20 MHz		40 MHz	
				DL	UL	DL	UL	DL	UL	DL	UL
MCS 15	2	64-QAM	5/6	18.7	3.64	42.2	10.7	87	27	178	56
MCS 14	2	64-QAM	3/4	16.5	3.38	37.7	9.75	78.4	24.1	162	51.6
MCS 13	2	64-QAM	2/3	14.7	3.09	32.8	8.97	69.4	21	143	44.6
MCS 12	2	16-QAM	3/4	10.9	2.21	24.6	6.63	52.1	16.1	108	34
MCS 11	2	16-QAM	1/2	7.04	1.42	16.5	4.3	34.7	10.4	72.9	22.3
MCS 10	2	QPSK	3/4	5.47	1.03	12.3	3.2	25.9	7.8	54.4	16.6
MCS 9	2	QPSK	1/2	3.52	0.619	8.2	2.14	17.2	5.16	36.3	11.1
MCS 7	1	64-QAM	5/6	9.36	1.88	21.1	5.46	43.5	13.7	91.7	28.2
MCS 6	1	64-QAM	3/4	8.2	1.65	18.8	4.88	39.2	11.9	82.3	25.8
MCS 5	1	64-QAM	2/3	7.04	1.55	16.4	4.3	34.7	10.6	72.9	22.3

MCS 4	1	16-QAM	3/4	7.08	6.69	14.7	14.5	30	29.1	61.9	57.6
MCS 3	1	16-QAM	1/2	4.85	4.56	9.67	9.64	20.1	19.4	41.5	41.2
MCS 2	1	QPSK	3/4	3.54	3.37	7.35	7.18	15	14.4	31	30.8
MCS 1	1	QPSK	1/2	2.56	2.25	5.01	4.75	10.2	9.67	20.8	20.5

**Table 194** Throughput for ePMP (50/50 Ratio)

MCS	Spatial Streams	Mod. Type	Coding Rate	5 MHz		10 MHz		20 MHz		40 MHz	
				DL	UL	DL	UL	DL	UL	DL	UL
MCS 15	2	64-QAM	5/6	10.5	11.4	25.9	26.9	56.5	58.4	115	114
MCS 14	2	64-QAM	3/4	9.35	10.3	23.4	24.2	50.6	51.8	104	105
MCS 13	2	64-QAM	2/3	8.19	9.17	21.1	21.5	44.6	46.7	94.2	95.7
MCS 12	2	16-QAM	3/4	6.23	6.9	15.6	16	33.6	34.8	70.4	72.3
MCS 11	2	16-QAM	1/2	4.09	4.56	10.5	10.6	22.4	23.1	46.9	47.8
MCS 10	2	QPSK	3/4	3.12	3.38	7.84	8.01	16.4	17.1	35.2	35.9
MCS 9	2	QPSK	1/2	1.95	2.24	5.08	5.27	11.1	11.3	23.4	23.5
MCS 7	1	64-QAM	5/6	5.26	5.85	12.9	13.7	28.2	28.7	58.9	60.8
MCS 6	1	64-QAM	3/4	4.68	5.33	11.7	12.2	25.8	25.9	54.1	53.7
MCS 5	1	64-QAM	2/3	4.21	4.69	10.5	10.7	22.3	23.1	47.1	48
MCS 4	1	16-QAM	3/4	3.12	3.45	7.82	8.01	16.8	17.1	35.2	36
MCS 3	1	16-QAM	1/2	2	2.26	5.16	5.3	11.1	11.3	23.4	23.8
MCS 2	1	QPSK	3/4	1.55	1.66	3.75	3.91	8.22	8.47	17.6	17.9
MCS 1	1	QPSK	1/2	0.938	1.07	2.35	2.35	5.49	5.63	11.8	11.8

**Table 195** Throughput for ePMP (30/70 Ratio)

MCS	Spatial Streams	Mod. Type	Coding Rate	5 MHz		10 MHz		20 MHz		40 MHz	
				DL	UL	DL	UL	DL	UL	DL	UL
MCS 15	2	64-QAM	5/6	4.2	18	12.9	39.6	31.7	82	68.2	134
MCS 14	2	64-QAM	3/4	3.73	15.8	11.7	36	28.1	74.2	61.2	132
MCS 13	2	64-QAM	2/3	3.26	14.3	10.3	32.4	25.8	65.5	54.1	131
MCS 12	2	16-QAM	3/4	2.33	10.8	7.8	23.9	18.8	49.2	39.9	101
MCS 11	2	16-QAM	1/2	1.56	7.04	5.15	16	12.5	32.8	26.6	68
MCS 10	2	QPSK	3/4	1.17	5.34	3.9	11.7	9.36	24.4	20	51.2
MCS 9	2	QPSK	1/2	0.778	3.51	2.35	7.82	6.24	16.2	12.9	34
MCS 7	1	64-QAM	5/6	2.32	9.11	6.47	19.8	15.7	41	32.9	86.6
MCS 6	1	64-QAM	3/4	1.95	8.13	5.86	17.9	14.1	37.3	30.6	77
MCS 5	1	64-QAM	2/3	1.56	7.04	5.15	16	12.5	32.7	26.7	68
MCS 4	1	16-QAM	3/4	1.17	5.34	3.9	11.7	9.37	24.6	20	51.2
MCS 3	1	16-QAM	1/2	0.778	3.52	2.35	7.82	6.25	16.3	13.3	34.1

---

MCS 2	1	QPSK	3/4	0.469	2.62	1.88	5.86	4.67	12.1	9.85	25.5
MCS 1	1	QPSK	1/2	0.312	1.75	1.17	3.9	3.02	8.08	6.48	17

---

## Radio Specifications

### EPMP 2000 PRODUCT SPECIFICATIONS

For up-to-date performance and mechanical specifications for ePMP 2000 products, please visit:

<http://www.cambiumnetworks.com/products/access/epmp-2000/>



### EPMP 1000 PRODUCT SPECIFICATIONS

For up-to-date performance and mechanical specifications for ePMP 1000 products, please visit:

<http://www.cambiumnetworks.com/products/access/epmp-1000/>





## Glossary

**Table 196** Glossary

Term	Definition
AES	Advanced Encryption Standard
ANSI	American National Standards Institute
AP	Access Point
CINR	Carrier to Interference plus Noise Ratio
CMM	Cluster Management Module
CNSS	Cambium Network Services Server
DFS	Dynamic Frequency Selection
EIRP	Equivalent Isotropically Radiated Power
EMC	Electromagnetic Compatibility
EMD	Electromagnetic Discharge
ETH	Ethernet
ETSI	European Telecommunications Standards Institute
FCC	Federal Communications Commission
FEC	Forward Error Correction
GPS	Global Positioning System
GUI	Graphical User Interface
HTTP	Hypertext Transfer Protocol
IC	Industry Canada
IEEE	Institute of Electrical and Electronics Engineers
IP	Internet Protocol
LAN	Local Area Network
LED	Light Emitting Diode
LOS	Line of Sight
MIMO	Multiple In Multiple Out
MTU	Maximum Transmission Unit
nLOS	Near Line of Sight
NTP	Network Time Protocol
OFDM	Orthogonal Frequency Division Multiplexing
PC	Personal Computer
PMP	Point to Multipoint
QAM	Quadrature Amplitude Modulation
QPSK	Quadrature Phase Shift Keyed
RF	Radio Frequency
RMA	Return Merchandise Authorization
RSSI	Received Signal Strength Indication
RTTT	Road Transport and Traffic Telematics
RX	Receive
SAR	Standard Absorption Rate
SNMP	Simple Network Management Protocol
SM	Subscriber Module
SW	Software
TDD	Time Division Duplex
TDWR	Terminal Doppler Weather Radar
TX	Transmit
UNII	Unlicensed National Information Infrastructure
URL	Uniform Resource Locator

