



Installation Guide

PTP 820G
System Release 10.9



Accuracy

While reasonable efforts have been made to assure the accuracy of this document, Cambium Networks assumes no liability resulting from any inaccuracies or omissions in this document, or from use of the information obtained herein. Cambium reserves the right to make changes to any products described herein to improve reliability, function, or design, and reserves the right to revise this document and to make changes from time to time in content hereof with no obligation to notify any person of revisions or changes. Cambium does not assume any liability arising out of the application or use of any product, software, or circuit described herein; neither does it convey license under its patent rights or the rights of others. It is possible that this publication may contain references to, or information about Cambium products (machines and programs), programming, or services that are not announced in your country. Such references or information must not be construed to mean that Cambium intends to announce such Cambium products, programming, or services in your country.

Copyrights

This document, Cambium products, and 3rd Party software products described in this document may include or describe copyrighted Cambium and other 3rd Party supplied computer programs stored in semiconductor memories or other media. Laws in the United States and other countries preserve for Cambium, its licensors, and other 3rd Party supplied software certain exclusive rights for copyrighted material, including the exclusive right to copy, reproduce in any form, distribute and make derivative works of the copyrighted material. Accordingly, any copyrighted material of Cambium, its licensors, or the 3rd Party software supplied material contained in the Cambium products described in this document may not be copied, reproduced, reverse engineered, distributed, merged or modified in any manner without the express written permission of Cambium. Furthermore, the purchase of Cambium products shall not be deemed to grant either directly or by implication, estoppel, or otherwise, any license under the copyrights, patents or patent applications of Cambium or other 3rd Party supplied software, except for the normal non-exclusive, royalty free license to use that arises by operation of law in the sale of a product.

Restrictions

Software and documentation are copyrighted materials. Making unauthorized copies is prohibited by law. No part of the software or documentation may be reproduced, transmitted, transcribed, stored in a retrieval system, or translated into any language or computer language, in any form or by any means, without prior written permission of Cambium.

License Agreements

The software described in this document is the property of Cambium and its licensors. It is furnished by express license agreement only and may be used only in accordance with the terms of such an agreement.

High Risk Materials

Cambium and its supplier(s) specifically disclaim any express or implied warranty of fitness for any high risk activities or uses of its products including, but not limited to, the operation of nuclear facilities, aircraft navigation or aircraft communication systems, air traffic control, life support, or weapons systems ("High Risk Use"). Any High Risk is unauthorized, is made at your own risk and you shall be responsible for any and all losses, damage or claims arising out of any High Risk Use.

© 2019 Cambium Networks Limited. All Rights Reserved.

Phn-3967

Contents

About This User Guide	1
Contacting Cambium Networks	1
Purpose	2
Cross references	2
Feedback	2
Problems and warranty	3
Reporting problems.....	3
Repair and service	3
Hardware warranty	3
Security advice	4
Warnings, cautions, and notes	5
Warnings	5
Cautions.....	5
Notes	5
Caring for the environment	6
In EU countries	6
In non-EU countries.....	6
Chapter 1: Product description.....	1-1
Important Notes	1-2
General Equipment Precautions	1-2
Safety Precautions & Declared Material.....	1-4
Précautions générales relatives à l'équipement	1-4
Allgemeine Vorsichtsmaßnahmen für die Anlage	1-4
Chapter 2: PTP 820G Hardware Description	2-1
Ethernet Traffic Interfaces	2-2
Ethernet Traffic Interface LEDs	2-2
Ethernet Traffic Interface Pin-Outs	2-3
Ethernet Management Interfaces.....	2-4
Management Interface Cable Options	2-4
Management Interface LEDs	2-4
Management Interface Pin-Outs.....	2-5
TDM Interfaces (E1/DS1 1x16) (Optional)	2-6
E1/DS1 Interface LEDs.....	2-6
E1/DS1 Interface Pin-Outs.....	2-6
Radio Interfaces	2-10
Radio Interface LEDs.....	2-10
Power Interfaces	2-12

Power Interface LEDs	2-12
Synchronization Interface	2-13
Synchronization Interface LEDs.....	2-13
Synchronization Interface Pin-Outs.....	2-13
Terminal Interface	2-15
Terminal Interface Pin-Outs	2-15
External Alarms.....	2-16
External Alarm Pin-Outs	2-16
Unit/ACT LED	2-17
PTP 820 Assured Platform	2-18
Chapter 3: Preparation for Installation.....	3-1
Transportation/Storage	3-2
Inspection	3-3
Unpacking Equipment at the Site	3-4
Chapter 4: Installing the PTP 820G	4-1
Kits required to perform the installation	4-1
Tools	4-1
Installing the PTP 820G IDU in the Rack (19")	4-2
Grounding the PTP 820G	4-3
Chapter 5: Connecting Power Cable	5-1
Power Supply Notes.....	5-3
Chapter 6: Cabling Requirements for Unit Redundancy	6-1
Cabling for Ethernet Interfaces.....	6-2
Cabling for E1/DS1 Interfaces	6-3
Cabling for T3 Synchronization	6-4
Inter-IDU Protection Connectivity and Management.....	6-5
Chapter 7: Performing Initial Configuration	7-6
Establishing a Connection	7-7
Connecting to the Unit with a Serial Connection	7-7
Logging On	7-9
Changing Your Password.....	7-10
Configuration	7-11
Chapter 8: Specifications.....	8-1
Environmental Specifications for IDU	8-1
Environmental Specifications for RFU	8-1
Mechanical Specifications	8-1
Power Consumption Specifications.....	8-2
Chapter 9: Acceptance & Commissioning Procedures	9-3
Site Acceptance Procedure	9-4
Site Acceptance Checklist Notes.....	9-9
Radio Link Commissioning Procedure.....	9-11
Scope	9-11

Commissioning Test	9-11
PTP 820 Commissioning Log	9-12

Figures

Figure 1 PTP 820G Front Panel and Interfaces	2-1
Figure 2 Electrical GE Interface LEDs	2-2
Figure 3 Optical GE Interface LED	2-3
Figure 4 Management Interface Pin Connections	2-4
Figure 5 Management FE Interface LEDs	2-5
Figure 6 TDM Interface LEDs.....	2-6
Figure 7 Radio Interface LEDs	2-11
Figure 8 Power Interface LEDs.....	2-12
Figure 9 Sync Interface LEDs.....	2-13
Figure 10 Unit/ACT LED	2-17
Figure 11 IDU (Full Configuration)	4-1
Figure 12 Power Supply Grounding.....	5-1
Figure 13 PTP 820G with Unit Redundancy – Protection and Management Connection.....	6-5
Figure 14 Terminal Interface	7-7
Figure 15 Management Interface	7-7
Figure 16 Change User Password Page.....	7-10

Tables

Table 1 GbE Interface Pin-Out Diagram (GbE1, GbE2, GbE3, GbE4).....	2-3
Table 2 PTP820 Ethernet split cable for Management	2-4
Table 3 Management Interface Pin-Out Diagram (MGMT)	2-5
Table 4 E1/DS1 Interface Pin-Out Diagram (E1/DS1 1-16)	2-6
Table 5 Synchronization Interface Pin-Out Diagram.....	2-13
Table 6 Terminal Interface Pin-Out Diagram	2-15
Table 7 External Alarm Interface Pin-Out Diagram.....	2-16
Table 8 Required Kits for installation.....	4-1
Table 9 Y-Cable for Electrical Splitter Mode FE Traffic Interface Protection	6-2
Table 10 Y-Cable for E1/DS1 Protection	6-3
Table 11 Splitter Cable for Protection and Management.....	6-5
Table 12 IDU Mechanical Specifications	8-1
Table 13 RFU-C Mechanical Specifications	8-2
Table 14 Power Consumption specifications.....	8-2

About This User Guide

This guide describes installation procedure of PTP 820G.

This guide contains the following chapters:

- [Chapter 1: Product description](#)
- [Chapter 2: PTP 820G Hardware Description](#)
- [Chapter 3: Preparation for Installation](#)
- [Chapter 4: Installing the PTP 820G](#)
- [Chapter 5: Connecting Power Cable](#)
- [Chapter 6: Cabling Requirements for Unit Redundancy](#)
- [Chapter 7: Performing Initial Configuration](#)
- [Chapter 8: Specifications](#)
- [Chapter 9: Acceptance & Commissioning Procedures](#)

Contacting Cambium Networks

Support website:	https://support.cambiumnetworks.com
Main website:	http://www.cambiumnetworks.com
Sales enquiries:	solutions@cambiumnetworks.com
Support enquiries:	https://support.cambiumnetworks.com
Repair enquiries:	https://support.cambiumnetworks.com
Telephone number list:	http://www.cambiumnetworks.com/support/contact-support
Address:	Cambium Networks Limited, Linhay Business Park, Eastern Road, Ashburton, Devon, UK, TQ13 7UP

Purpose

Cambium Networks Point-To-Point (PTP) documents are intended to instruct and assist personnel in the operation, installation and maintenance of the Cambium PTP equipment and ancillary devices. It is recommended that all personnel engaged in such activities be properly trained.

Cambium disclaims all liability whatsoever, implied or express, for any risk of damage, loss or reduction in system performance arising directly or indirectly out of the failure of the customer, or anyone acting on the customer's behalf, to abide by the instructions, system parameters, or recommendations made in this document.

Cross references

References to external publications are shown in italics. Other cross references, emphasized in blue text in electronic versions, are active links to the references.

This document is divided into numbered chapters that are divided into sections. Sections are not numbered, but are individually named at the top of each page, and are listed in the table of contents.

Feedback

We appreciate feedback from the users of our documents. This includes feedback on the structure, content, accuracy, or completeness of our documents. Send feedback to support@cambiumnetworks.com.

Problems and warranty

Reporting problems

If any problems are encountered when installing or operating this equipment, follow this procedure to investigate and report:

- 1 Search this document and the software release notes of supported releases.
- 2 Visit the support website.
- 3 Ask for assistance from the Cambium product supplier.
- 4 Gather information from affected units, such as any available diagnostic downloads.
- 5 Escalate the problem by emailing or telephoning support.

Repair and service

If unit failure is suspected, obtain details of the Return Material Authorization (RMA) process from the support website.

Hardware warranty

Cambium's standard hardware warranty is for one (1) year from date of shipment from Cambium Networks or a Cambium distributor. Cambium Networks warrants that hardware will conform to the relevant published specifications and will be free from material defects in material and workmanship under normal use and service. Cambium shall within this time, at its own option, either repair or replace the defective product within thirty (30) days of receipt of the defective product. Repaired or replaced product will be subject to the original warranty period but not less than thirty (30) days.

To register PTP products or activate warranties, visit the support website.

**Caution**

Using non-Cambium parts for repair could damage the equipment or void warranty. Contact Cambium for service and repair instructions.

Portions of Cambium equipment may be damaged from exposure to electrostatic discharge. Use precautions to prevent damage.

Security advice

Cambium Networks systems and equipment provide security parameters that can be configured by the operator based on their particular operating environment. Cambium recommends setting and using these parameters following industry recognized security practices. Security aspects to be considered are protecting the confidentiality, integrity, and availability of information and assets. Assets include the ability to communicate, information about the nature of the communications, and information about the parties involved.

In certain instances Cambium makes specific recommendations regarding security practices, however the implementation of these recommendations and final responsibility for the security of the system lies with the operator of the system.

Warnings, cautions, and notes

The following describes how warnings and cautions are used in this document and in all documents of the Cambium Networks document set.

Warnings

Warnings precede instructions that contain potentially hazardous situations. Warnings are used to alert the reader to possible hazards that could cause loss of life or physical injury. A warning has the following format:

**Warning**

Warning text and consequence for not following the instructions in the warning.

Cautions

Cautions precede instructions and are used when there is a possibility of damage to systems, software, or individual items of equipment within a system. However, this damage presents no danger to personnel. A caution has the following format:

**Caution**

Caution text and consequence for not following the instructions in the caution.

Notes

A note means that there is a possibility of an undesirable situation or provides additional information to help the reader understand a topic or concept. A note has the following format:

**Note**

Note text.

Caring for the environment

The following information describes national or regional requirements for the disposal of Cambium Networks supplied equipment and for the approved disposal of surplus packaging.

In EU countries

The following information is provided to enable regulatory compliance with the European Union (EU) directives identified and any amendments made to these directives when using Cambium equipment in EU countries.



Disposal of Cambium equipment

European Union (EU) Directive 2002/96/EC Waste Electrical and Electronic Equipment (WEEE)

Do not dispose of Cambium equipment in landfill sites. For disposal instructions, refer to

<http://www.cambiumnetworks.com/support/weee-compliance>

Disposal of surplus packaging

Do not dispose of surplus packaging in landfill sites. In the EU, it is the individual recipient's responsibility to ensure that packaging materials are collected and recycled according to the requirements of EU environmental law.

In non-EU countries

In non-EU countries, dispose of Cambium equipment and all surplus packaging in accordance with national and regional regulations.

Chapter 1: Product description

This chapter provides an overview of the PTP 820G, high-performance edge node product. PTP 820G is specially designed for edge/tail sites, and features a small footprint, high density, and a high degree of availability.

PTP 820G is an integral part of the PTP family of high-capacity wireless backhaul products. Together, the PTP family of products provides a wide variety of backhaul solutions that can be used separately or combined to form integrated backhaul networks or network segments.







This chapter includes:

- [Important Notes](#)
- [Safety Precautions & Declared Material](#)

Important Notes

- For the warranty to be honored, install the unit in accordance with the instructions in this manual.
- Any changes or modifications of equipment not expressly approved by the manufacturer could void the user's authority to operate the equipment and the warranty for such equipment.
- PTP 820G is intended for installation in a restricted access location.
- PTP 820G must be installed and permanently connected to protective earth by qualified service personnel in accordance with applicable national electrical codes.

General Equipment Precautions

	<p>Caution</p> <p>To avoid malfunctioning or personnel injuries, equipment or accessories/kits/plug-in unit installation, requires qualified and trained personnel. Changes or modifications not expressly approved by Cambium Networks can void user's authority to operate the equipment.</p>
	<p>Caution</p> <p>Where special cables, shields, adapters and grounding kits are supplied or described in this manual, these items must be used to comply with the FCC regulations.</p>
	<p>Caution</p> <p>Use of controls, adjustments, or performing procedures other than those specified herein, may result in hazardous radiation exposure.</p>
	<p>Caution</p> <p>When working with a PTP 820G, note the following risk of electric shock and energy hazard: Disconnecting one power supply disconnects only one power supply module. To isolate the unit completely, disconnect all power supplies.</p>
	<p>Caution</p> <p>Machine noise information order: 3. GPSGV, the highest sound pressure level amounts to 70 dB (A) or less, in accordance with ISO EN 7779.</p>
	<p>Antistatic</p> <p>Static electricity may cause body harm, as well as harm to electronic components inside the device. Anyone responsible for the installation or maintenance of the PTP 820G must use an ESD Wrist Strap. ESD protection measures must be observed when touching the unit. To prevent damage, before touching components inside the device, all electrostatic must be discharged from both personnel and tools.</p>
	<p>Caution</p> <p>In Norway and Sweden:</p>



Equipment connected to the protective earthing of the building installation through the mains connection or through other equipment with a connection to protective earthing – and to a cable distribution system using coaxial cable, may in some circumstances create a fire hazard. Connection to a cable distribution system has therefore to be provided through a device providing electrical isolation below a certain frequency range (galvanic isolator, see EN 60728-11).

Utstyr som er koplet til beskyttelsesjord via nettplugg og/eller via annet jordtilkoplede utstyr – og er tilkoplede et kabel-TV nett, kan forårsake brannfare. For å unngå dette skal det ved tilkopling av utstyret til kabel-TV nettet installeres en galvanisk isolator mellom utstyret og kabel-TV nettet.



Utrustning som är kopplad till skyddsjord via jordat vägguttag och/eller via annan utrustning och samtidigt är kopplad till kabel-TV nät kan i vissa fall medföra risk för brand. För att undvika detta skall vid anslutning av utrustningen till kabel-TV nät galvanisk isolator finnas mellan utrustningen och kabel-TV nätet.

Safety Precautions & Declared Material

Précautions générales relatives à l'équipement

	<p>Caution</p> <p>L'utilisation de commandes ou de réglages ou l'exécution de procédures autres que celles spécifiées dans les présentes peut engendrer une exposition dangereuse aux rayonnements.</p>
	<p>Caution</p> <p>L'usage de PTP 820G s'accompagne du risque suivant d'électrocution et de danger électrique : le débranchement d'une alimentation électrique ne déconnecte qu'un module d'alimentation électrique. Pour isoler complètement l'unité, il faut débrancher toutes les alimentations électriques.</p>
	<p>Caution</p> <p>Bruit de machine d'ordre - 3. GPSGV, le plus haut niveau de pression sonore s'élève à 70 dB (A) au maximum, dans le respect de la norme ISO EN 7779.</p>

Allgemeine Vorsichtsmaßnahmen für die Anlage

	<p>Caution</p> <p>Wenn andere Steuerelemente verwendet, Einstellungen vorgenommen oder Verfahren durchgeführt werden als die hier angegebenen, kann dies gefährliche Strahlung verursachen.</p>
	<p>Caution</p> <p>Beachten Sie beim Arbeiten mit PTP 820G das folgende Stromschlag- und Gefahrenrisiko: Durch Abtrennen einer Stromquelle wird nur ein</p>
	<p>Caution</p> <p>Stromversorgungsmodul abgetrennt. Um die Einheit vollständig zu isolieren, trennen Sie alle Stromversorgungen ab.</p> <p>Maschinenlärminformations-Verordnung - 3. GPSGV, der höchste Schalldruckpegel beträgt 70 dB(A) oder weniger gemäß EN ISO 7779.</p>

Chapter 2: PTP 820G Hardware Description

PTP 820G is a compact unit that fits in a single rack unit, with a passive cooling system that eliminates the need for fans. A PTP 820G system consists of a PTP 820G indoor unit (IDU) and one or two radio frequency units (RFUs). A coaxial cable connects the IDU to each RFU, transmits traffic and management data between the IDU and the RFU, and provides DC -48V power to the RFU.

A PTP 820G IDU contains six Ethernet interfaces, one or two radio interfaces depending on the hardware configuration, and optionally a 16 x E1/DS1 interface.

The IDU also includes two FE management interfaces, a DB9 dry contact external alarms interface, an RJ-45 synchronization interface, and an RJ-45 terminal console interface for connection to a local craft terminal.

PTP 820G receives an external supply of -48V, with an optional second power interface for power redundancy.

The following hardware assembly options are available for the PTP 820G IDU:

- One or two radio interfaces
- With or without 16 x E1/DS1 interfaces

Figure 1 PTP 820G Front Panel and Interfaces

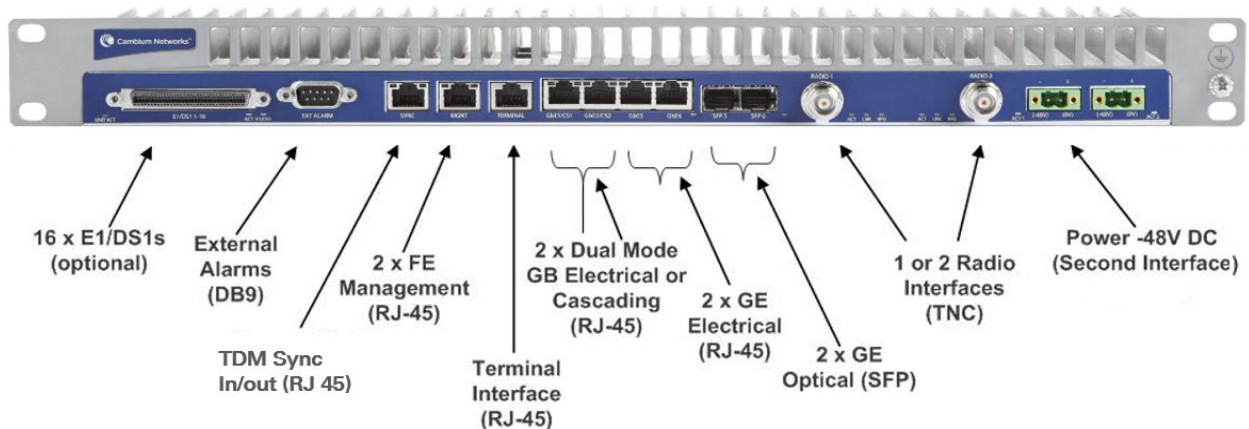

Ethernet Traffic Interfaces

The front panel of the PTP 820G contains four electrical and two optical GE Ethernet traffic interfaces:

- 2 x GE dual mode electrical or cascading interfaces (RJ-45) – GbE1/CS1, GbE2/CS2
- 2 x GE electrical interfaces (RJ-45) – GbE3, GbE4
- 2 x GE optical interfaces (SFP) – SFP5, SFP6

Ethernet Traffic Interface LEDs

Each electrical interface has the following LEDs:

- **Port Status LED** – Located on the upper left of each interface. Indicates the link status of the interface, as follows:
 - **Off** – The interface is shut down or the signal is lost.
 - **Green** – The interface is enabled and the link is operational.
 - **Blinking Green** – The interface is transmitting and/or receiving traffic.
- **Port Rate LED** – Located on the upper right of each interface. Indicates the speed of the interface, as follows:
 - **Off** – 100Base-TX
 - **Green** – 1000Base-T
 - **Blinking Green** – 10Base-T

Figure 2 Electrical GE Interface LEDs

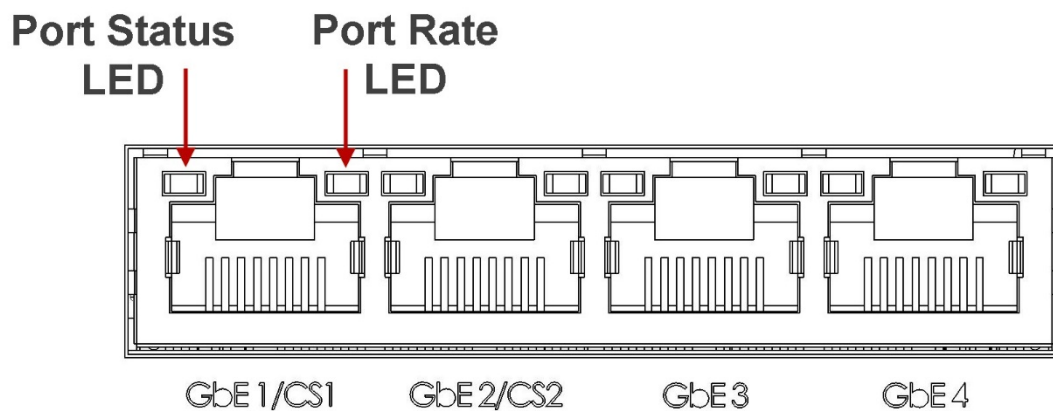

Each optical interface has the following LED:

- **Port Status LED** – A Port Status LED is located on the lower left of SFP5 and the lower right of SFP6. Each LED indicates the link status of the interface, as follows:
 - **Off** – The interface is shut down or the signal is lost.
 - **Green** – The interface is enabled and the link is operational.
 - **Blinking Green** – The interface is transmitting and/or receiving traffic.

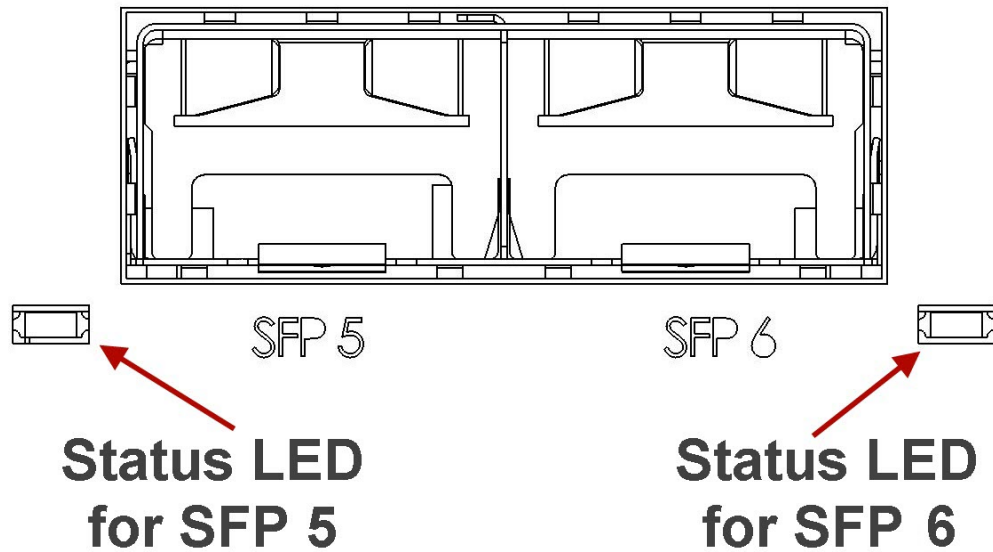
Figure 3 Optical GE Interface LED

Ethernet Traffic Interface Pin-Outs

Table 1 GbE Interface Pin-Out Diagram (GbE1, GbE2, GbE3, GbE4)

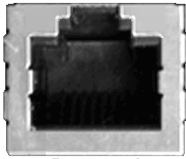
RJ45	Pin no.	Description
 <p>8.....1</p>	1	BI_DA+ (Bi-directional pair +A)
	2	BI_DA- (Bi-directional pair -A)
	3	BI_DB+ (Bi-directional pair +B)
	4	BI_DC+ (Bi-directional pair +C)
	5	BI_DC- (Bi-directional pair -C)
	6	BI_DB- (Bi-directional pair -B)
	7	BI_DD+ (Bi-directional pair +D)
	8	BI_DD- (Bi-directional pair -D)

**Note**

When using electrical ports GbE 1 through GbE 4 to connect between the PTP 820G IDU and an outdoor unit such as PTP 820C or PTP 820S, in areas in which severe lightning conditions are likely to occur, it is required to use lightning protection.

Ethernet Management Interfaces

PTP 820G contains two FE management interfaces, which connect to a single RJ-45 physical connector on the front panel (MGMT).

Figure 4 Management Interface Pin Connections

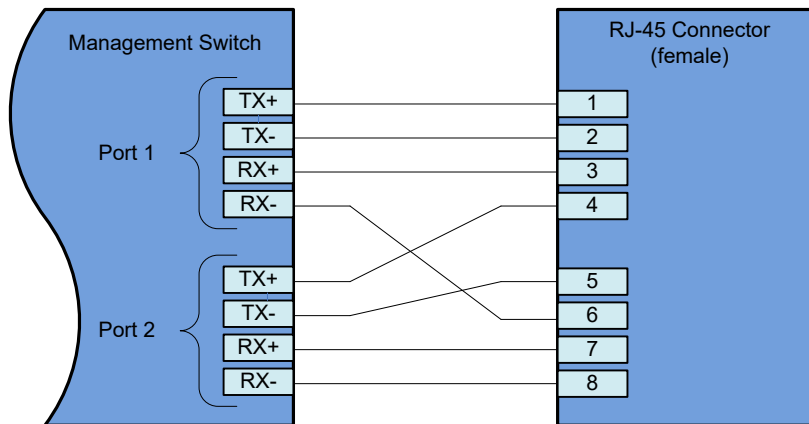

Management Interface Cable Options

If the user only needs to use a single management interface, a standard Cat5 RJ-45 cable (straight or cross) can be connected to the MGMT interface.

To access both management interfaces, a special Ethernet split cable for Management can be ordered from Cambium Networks.

Table 2 PTP820 Ethernet split cable for Management

Cambium Part No.	Marketing Description
N000082L122A	PTP820 Ethernet split cable for Management

Management Interface LEDs

The MGMT interface has the following LEDs:

- **Port Status LED** – The LED for management interface 1 is located on the upper left of the MGMT interface. The LED for management interface 2 is located on the upper right of the MGMT interface. Each LED indicates the link status of the interface, as follows:
 - **Off** – The cable is not connected or the signal is lost.



Note

The management interfaces cannot be shut down.

- **Green** – The interface is enabled and the link is operational.

- **Blinking Green** – The interface is transmitting and/or receiving management traffic.

Figure 5 Management FE Interface LEDs

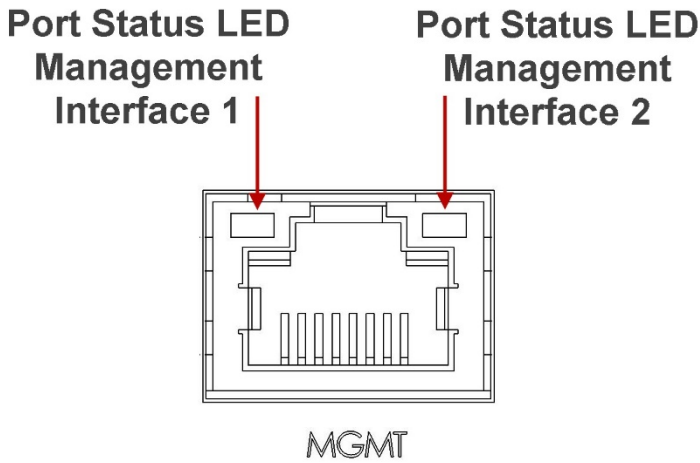

Management Interface Pin-Outs

Table 3 Management Interface Pin-Out Diagram (MGMT)

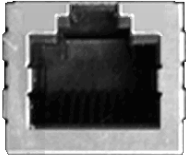
RJ45	Pin no.	Description
 <p>8.....1</p>	1	Port 1 – TX+
	2	Port 1 – TX-
	3	Port 1 – RX+
	4	Port 2 – TX+
	5	Port 2 – TX-
	6	Port 1 – RX-
	7	Port 2 – RX+
	8	Port 2 – RX-

TDM Interfaces (E1/DS1 1x16) (Optional)

Optionally, PTP 820G can be ordered with an MDR69 connector in which 16 E1/DS1 interfaces are available (ports 1 through 16).

E1/DS1 Interface LEDs

The E1/DS1 interface has the following LEDs

- **ACT LED** – Indicates whether the TDM card is working properly (Green) or if there is an error or a problem with the card's functionality (Red).
- **E1/DS1 LED** – Indicates whether the interfaces are enabled with no alarms (Green), with alarms (Red), or no interfaces enabled (Off).

Figure 6 TDM Interface LEDs

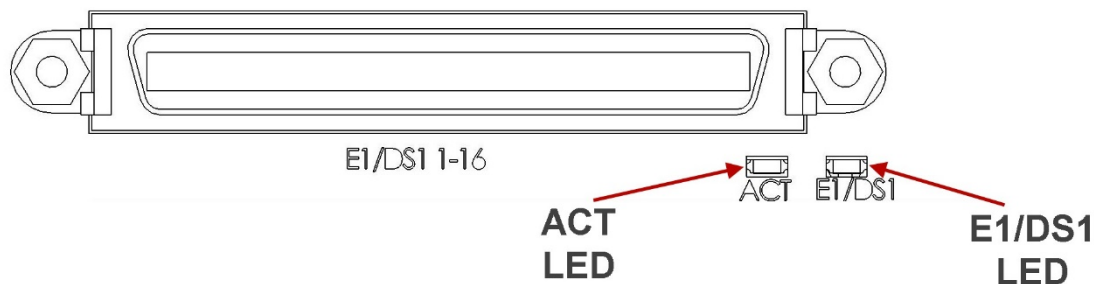

E1/DS1 Interface Pin-Outs

The 16 x E1/DS1 connector is a SCSI 68-pin connector.

Table 4 E1/DS1 Interface Pin-Out Diagram (E1/DS1 1-16)

Pin #	Signal	Label on the Twisted Pair	Type
1	OUT - TIP1	Ch1 Tx	TWISTED PAIR
35	OUT - RING1		
2	OUT - TIP2	Ch2 Tx	TWISTED PAIR
36	OUT - RING2		
3	OUT - TIP3	Ch3 Tx	TWISTED PAIR
37	OUT - RING3		
4	OUT - TIP4	Ch4 Tx	TWISTED PAIR

Pin #	Signal	Label on the Twisted Pair	Type
38	OUT - RING4		
5	OUT - TIP5	Ch5 Tx	TWISTED PAIR
39	OUT - RING5		
6	OUT - TIP6	Ch6 Tx	TWISTED PAIR
40	OUT - RING6		
7	OUT - TIP7	Ch7 Tx	TWISTED PAIR
41	OUT - RING7		
8	OUT - TIP8	Ch8 Tx	TWISTED PAIR
42	OUT - RING8		
9	OUT - TIP9	Ch9 Tx	TWISTED PAIR
43	OUT - RING9		
10	OUT - TIP10	Ch10 Tx	TWISTED PAIR
44	OUT - RING10		
11	OUT - TIP11	Ch11 Tx	TWISTED PAIR
45	OUT - RING11		
12	OUT - TIP12	Ch12 Tx	TWISTED PAIR
46	OUT - RING12		
13	OUT - TIP13	Ch13 Tx	TWISTED PAIR
47	OUT - RING13		
14	OUT - TIP14	Ch14 Tx	TWISTED PAIR
48	OUT - RING14		
15	OUT - TIP15	Ch15 Tx	TWISTED PAIR
49	OUT - RING15		
16	OUT - TIP16	Ch16 Tx	TWISTED PAIR
50	OUT - RING16		
19	IN - TIP1	Ch1 Rx	TWISTED PAIR
53	IN - RING1		
20	IN - TIP2	Ch2 Rx	TWISTED PAIR
54	IN - RING2		

Pin #	Signal	Label on the Twisted Pair	Type
21	IN - TIP3	Ch3 Rx	TWISTED PAIR
55	IN - RING3		
22	IN - TIP4	Ch4 Rx	TWISTED PAIR
56	IN - RING4		
23	IN - TIP5	Ch5 Rx	TWISTED PAIR
57	IN - RING5		
24	IN - TIP6	Ch6 Rx	TWISTED PAIR
58	IN - RING6		
25	IN - TIP7	Ch7 Rx	TWISTED PAIR
59	IN - RING7		
26	IN - TIP8	Ch8 Rx	TWISTED PAIR
60	IN - RING8		
27	IN - TIP9	Ch9 Rx	TWISTED PAIR
61	IN - RING9		
28	IN - TIP10	Ch10 Rx	TWISTED PAIR
62	IN - RING10		
29	IN - TIP11	Ch11 Rx	TWISTED PAIR
63	IN - RING11		
30	IN - TIP12	Ch12 Rx	TWISTED PAIR
64	IN - RING12		
31	IN - TIP13	Ch13 Rx	TWISTED PAIR
65	IN - RING13		
32	IN - TIP14	Ch14 Rx	TWISTED PAIR
66	IN - RING14		
33	IN - TIP15	Ch15 Rx	TWISTED PAIR
67	IN - RING15		
34	IN - TIP16	Ch16 Rx	TWISTED PAIR
68	IN - RING16		
17	SHELL	-	SHIELD

Pin #	Signal	Label on the Twisted Pair	Type
18	SHELL	-	SHIELD
51	SHELL	-	SHIELD
52	SHELL	-	SHIELD

Radio Interfaces

PTP 820G includes one or two radio interfaces, depending on the hardware assembly option that was selected. Each radio interface uses a TNC connector type. Each radio interface is connected to an RFU via coaxial cable. This connection is used for traffic between the RFU and the IDU. It is also used to provide -48V DC power from the IDU to the RFU, as well as for management and configuration of the RFU.

The radio interfaces are labeled Radio 1 and, if there is a second radio interface, Radio 2.

Radio Interface LEDs

Each radio interface has the following set of LEDs. The LEDs for Radio 1 are located to the right of the interface. The LEDs for Radio 2 are located to the left of the interface.

The LEDs indicate the following:

- **ACT** – Indicates whether the interface is working properly (Green) or if there is an error or a problem with the interface’s functionality (Red), as follows:
 - **Off** – The radio is disabled.
 - **Green** – The radio is active and operating normally.
 - **Blinking Green** – The radio is operating normally and is in standby mode.
 - **Red** – There is a hardware failure.
 - **Blinking Red** – Troubleshooting mode.
- **LINK** – Indicates the status of the radio link, as follows:
 - **Green** – The radio link is operational.
 - **Red** – There is an LOF or Excessive BER alarm on the radio.
 - **Blinking Green** – An IF loopback is activated, and the result is OK.
 - **Blinking Red** – An IF loopback is activated, and the result is Failed.
- **RFU** – Indicates the status of the RFU, as follows:
 - **Green** – The RFU is functioning normally.
 - **Orange** – A minor RFU alarm or a warning is present, or the RFU is in TX mute mode, or, in a protected configuration, the RFU is in standby mode.
 - **Red** – A cable is disconnected, or a major or critical RFU alarm is present.
 - **Blinking Green** – An RF loopback has been activated, and the result is OK.
 - **Blinking Red** – An RF loopback has been activated, and the result is Failed.

Figure 7 Radio Interface LEDs

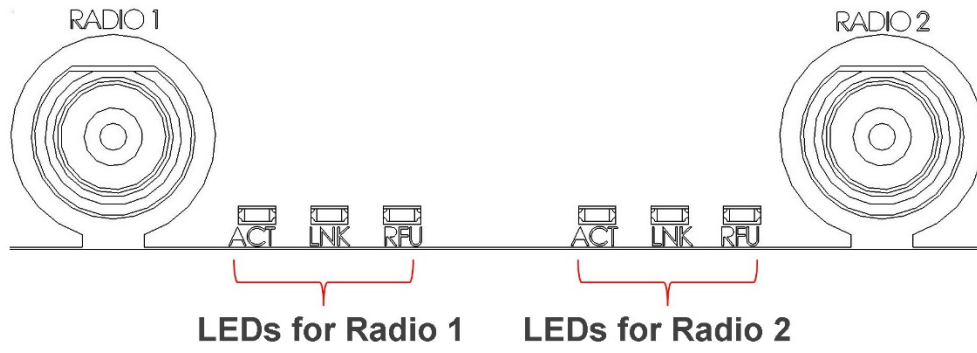

Power Interfaces

PTP 820G receives an external supply of -48V current via two power interfaces. The PTP 820G monitors the power supply for under-voltage and includes reverse polarity protection, so that if the positive (+) and negative (-) inputs are mixed up, the system remains shutdown.

The allowed power input range for the PTP 820G is -40V to -60V. An under voltage alarm is triggered if the power goes below the allowed range, and an over voltage alarm is triggered if the power goes above the allowed range.

Power Interface LEDs

There is an ACT LED for each power interface. The LED is Green when the voltage being fed to the power interface is within range, and Red if the voltage is not within range or if a power cable is not connected.

Figure 8 Power Interface LEDs

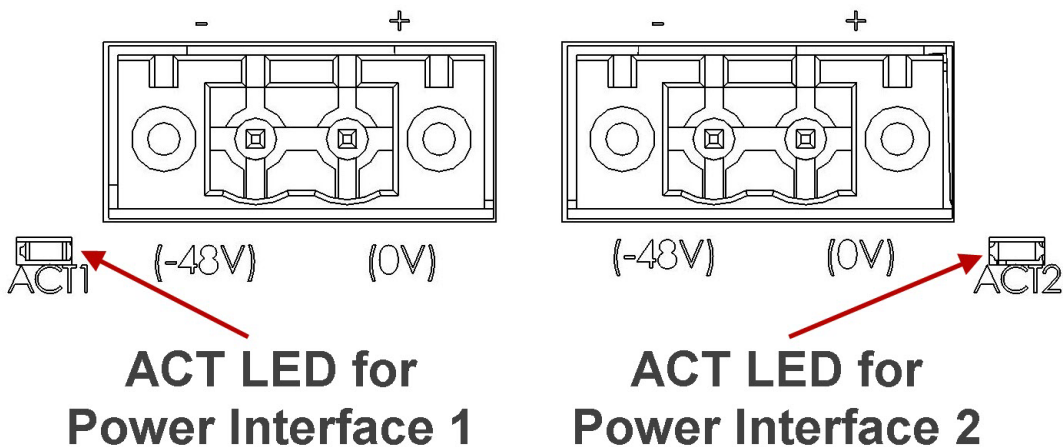

Synchronization Interface

PTP 820G includes an RJ-45 synchronization interface for T3 clock input and T4 clock output. The interface is labeled SYNC.

Synchronization Interface LEDs

The synchronization interface contains two LEDs, one on the upper left of the interface and one on the upper right of the interface, as follows:

- **T3 Status LED** – Located on the upper left of the interface. Indicates the status of T3 input clock, as follows:
 - **Off** – There is no T3 input clock, or the input is illegal.
 - **Green** – There is legal T3 input clock.
- **T4 Status LED** – Located on the upper right of the interface. Indicates the status of T4 output clock, as follows:
 - **Off** – T4 output clock is not available.
 - **Green** – T4 output clock is available.
 - **Blinking Green** – The clock unit is in a holdover state.

Figure 9 Sync Interface LEDs

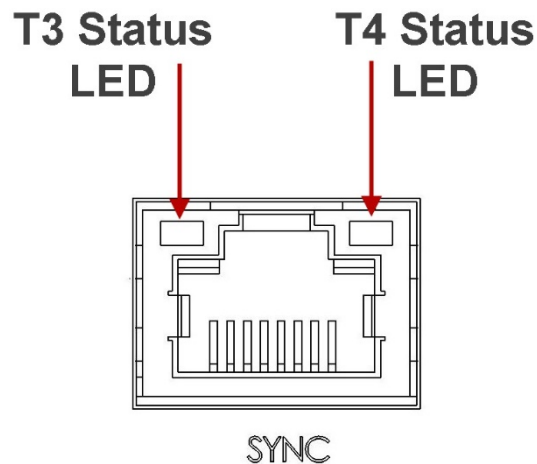

Synchronization Interface Pin-Outs

Table 5 Synchronization Interface Pin-Out Diagram

RJ45	Pin no.	Description
	1	T3_IN_N
	2	T3_IN_P
	3	1PPS_P

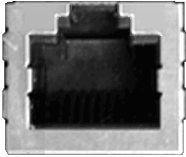
RJ45	Pin no.	Description
 <p data-bbox="358 409 457 443">8.....1</p>	4	T4_OUT_N
	5	T4_OUT_P
	6	1PPS_N
	7	ToD_P (or PPS_IN_P)
	8	ToD_N (or PPS_IN_N)

Terminal Interface

PTP 820G includes an RJ-45 terminal interface (RS-232). A local craft terminal can be connected to the terminal interface for local CLI management of the unit.

Terminal Interface Pin-Outs

Table 6 Terminal Interface Pin-Out Diagram

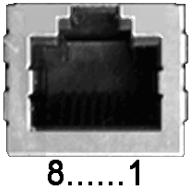
RJ45	Pin no.	Description
	1	NC
	2	NC
	3	NC
	4	GND
	5	Terminal-RX (System TX)
	6	Terminal-TX (System RX)
	7	NC
	8	NC

External Alarms

PTP 820G includes a DB9 dry contact external alarms interface. The external alarms interface supports five input alarms and a single output alarm.

The input alarms are configurable according to:

- 1 Intermediate
- 2 Critical
- 3 Major
- 4 Minor
- 5 Warning

The output alarm is configured according to predefined categories.

External Alarm Pin-Outs

Table 7 External Alarm Interface Pin-Out Diagram

DB-9	Pin no.	Description
	1	External input alarm #1
	2	External input alarm #2
	3	External input alarm #3
	4	External input alarm #4
	5	External input alarm #5
	6	Relay #1, normally closed pin
	7	Relay #1, common pin
	8	Relay #1, normally open pin
	9	GND



Unit/ACT LED

A general ACT LED for the unit is located on the lower left of the PTP 820G front panel. This LED is labeled UNIT/ACT, and indicates the general status of the unit, as follows:

- **Off** – Power is off.
- **Green** – Power is on, and no alarms are present on the unit. When the unit is part of a PTP 820G unit redundancy pair, Green indicates that the unit is in Active mode.
- **Orange** – Power is on, and there are minor alarms or warnings on the unit. When the unit is part of a PTP 820G unit redundancy pair, Orange indicates that the unit is in Standby mode.
- **Red** – Power is on, and there are major or critical alarms on the unit.

Figure 10 Unit/ACT LED

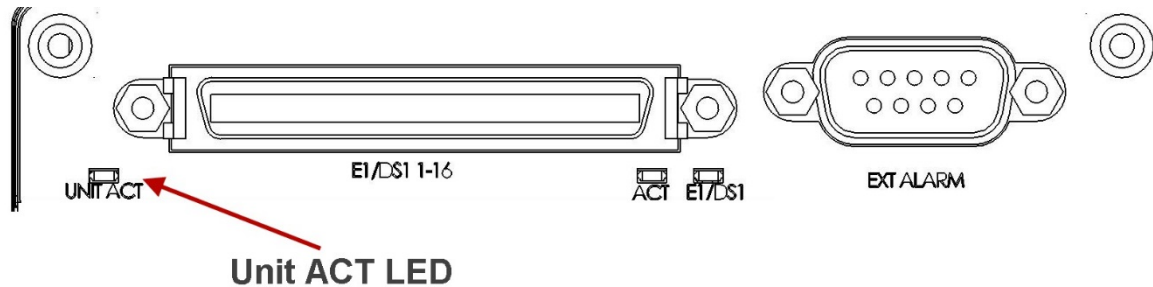

PTP 820 Assured Platform

PTP 820 Assured platform enhances network reliability and security, ensuring that mission-critical networks maintain availability, and protecting the confidentiality and integrity of their users' data.

The PTP 820 Assured platform is compliant with FIPS 140-2, including:

- Compliance with FIPS 140-2 specifications for cryptography module.
- FIPS 140-2 Level 2 physical security.
- AES-256 encryption (FIPS 197) over radio links.
- The PTP 820 Assured platform also provides:
 - Secured communication and protocols for management interface.
 - Centralized user authentication management via RADIUS.
 - Advanced identity management and password policy enforcement.
 - Security events log.
 - Secure product architecture and development.

The following products are included in the PTP 820 Assured platform:

- PTP 820G Assured
- PTP 820C Assured
- PTP 820S Assured

Note:



Note

PTP 820 Assured is supported with certain versions of release. To determine whether a specific release version supports PTP 820 Assured, check the Release Note.

Chapter 3: Preparation for Installation

This section provides instructions for transporting, inspecting and unpacking the equipment for a PTP 820G system prior to installation.

Transportation/Storage

The equipment cases are prepared for shipment by air, truck, railway and sea, suitable for handling by forklift trucks and slings. The cargo must be kept dry during transport and storage.

For sea-transport, deck-side shipment is not permitted. Carrier-owned cargo containers must be used.

It is recommended that the equipment is transported to the installation site in its original packing cases.

If any intermediate storing is required, all cases must be stored under dry and cool conditions and out of direct sunlight.

Inspection

Check the packing lists and ensure that correct parts numbers quantities of goods have arrived.

Inspect for any damage on the cases and equipment. Report any damage or discrepancy to a Cambium Networks support team (<http://www.cambiumnetworks.com/support>).

Unpacking Equipment at the Site

The equipment is packed in sealed plastic bags and moisture absorbing bags are inserted. Any separate sensitive products such as printed boards, are packed in anti-static handling bags. The equipment is further packed in special designed cases.

Marking is done according to standard practice unless otherwise specified by customers.

- Customers address
- Contract No
- Site name (if known)
- Case No

Dimensions and weight of each case are specified in the packing specification issued for the respective shipment.



Caution

It is essential that whenever unpacking or disassembling the equipment and handling printed circuit boards, special precautions must be taken to avoid ESD (Electrostatic Static Discharge). Generally, units with static discharge protection must not be unpacked until the installation takes place.

Ensure you are properly grounded at a controlled ESD point before and during unpacking and handling of any sensitive component.

To avoid malfunctioning or personnel injuries, equipment or accessories/kits/plug-in unit installation, requires qualified and trained personnel.

Changes or modifications not expressly approved by Cambium Networks could void the user's authority to operate the equipment

Where special cables, shields, adapters and grounding kits are supplied or described in this manual, these items must be used, to comply with the relevant regulations

Chapter 4: Installing the PTP 820G

This section provides instructions for installing a PTP 820G IDU.

Figure 11 IDU (Full Configuration)

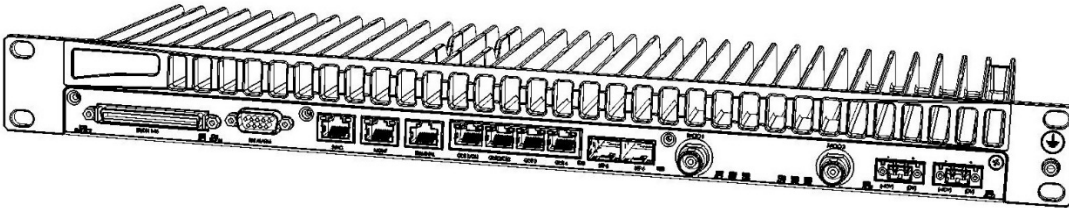

Kits required to perform the installation

Table 8 Required Kits for installation

Description	Quantity
PTP 820G chassis	1
19" rack / sub-rack	1

Tools

- Philips screwdriver
- Flat screwdriver

Installing the PTP 820G IDU in the Rack (19")

Insert and hold the PTP 820G IDU in the rack, as shown in the following figures. Use four screws (not supplied with the installation kit) to fasten the IDU to the rack.

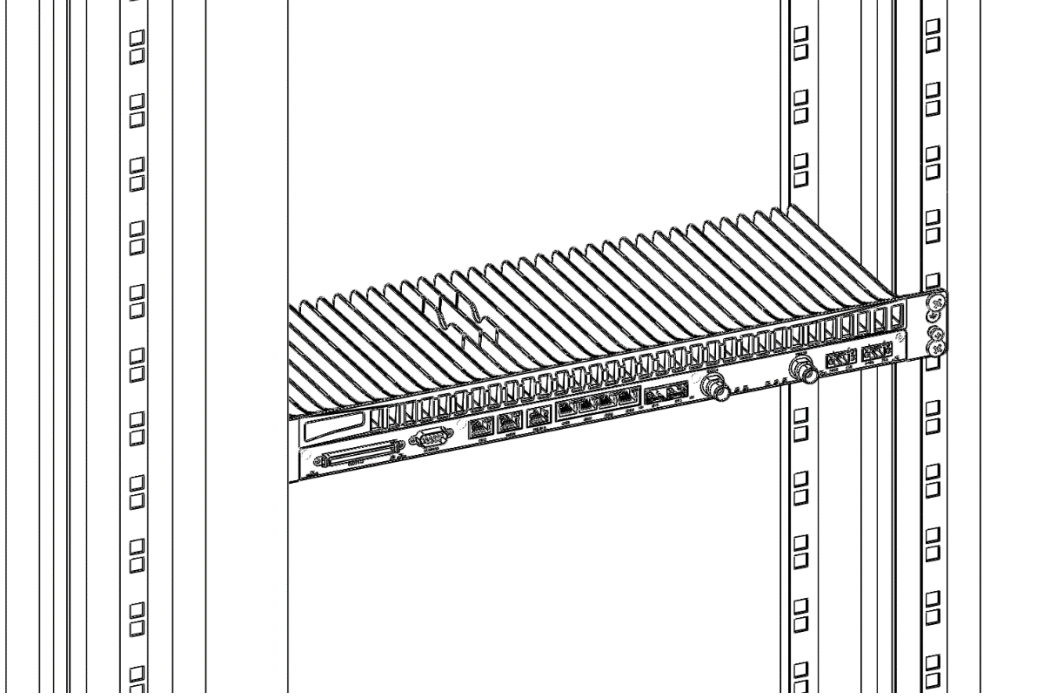

If you are installing multiple PTP 820G units in a single rack, make sure to leave a space of 1RU after every two PTP 820G units, as shown in the figure below. This restriction also applies to PTP 820G units installed in proximity with third party units.

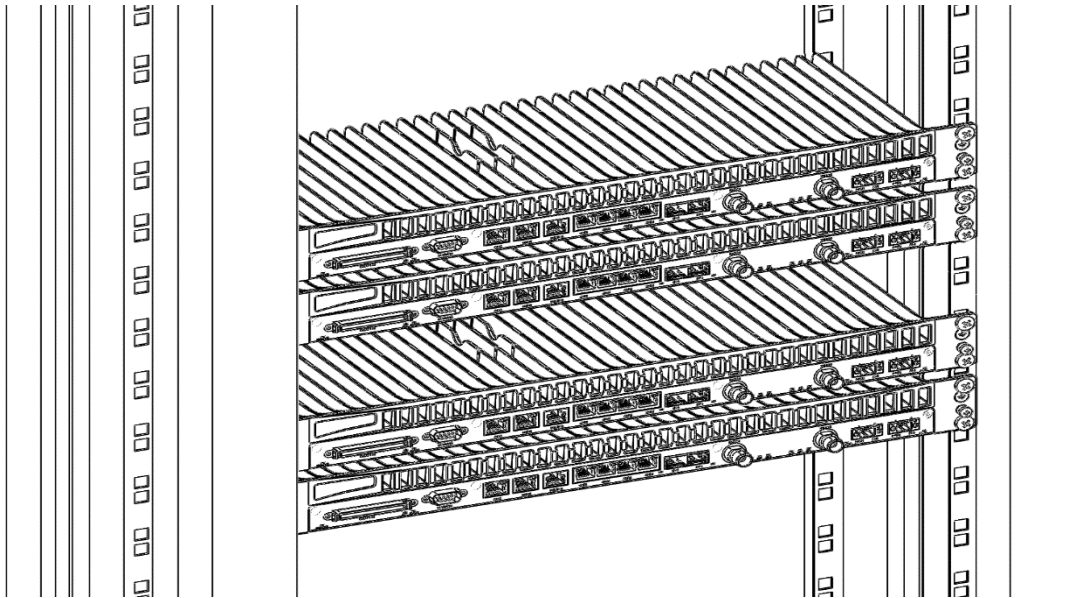

Grounding the PTP 820G

Connect a grounding wire first to the single-point stud shown in the figure below, and then to the rack, using a single screw and two washers. Verify that the grounding resistance is 0-2 ohms.

**Note**

The grounding wire must be 16 AWG or thicker.

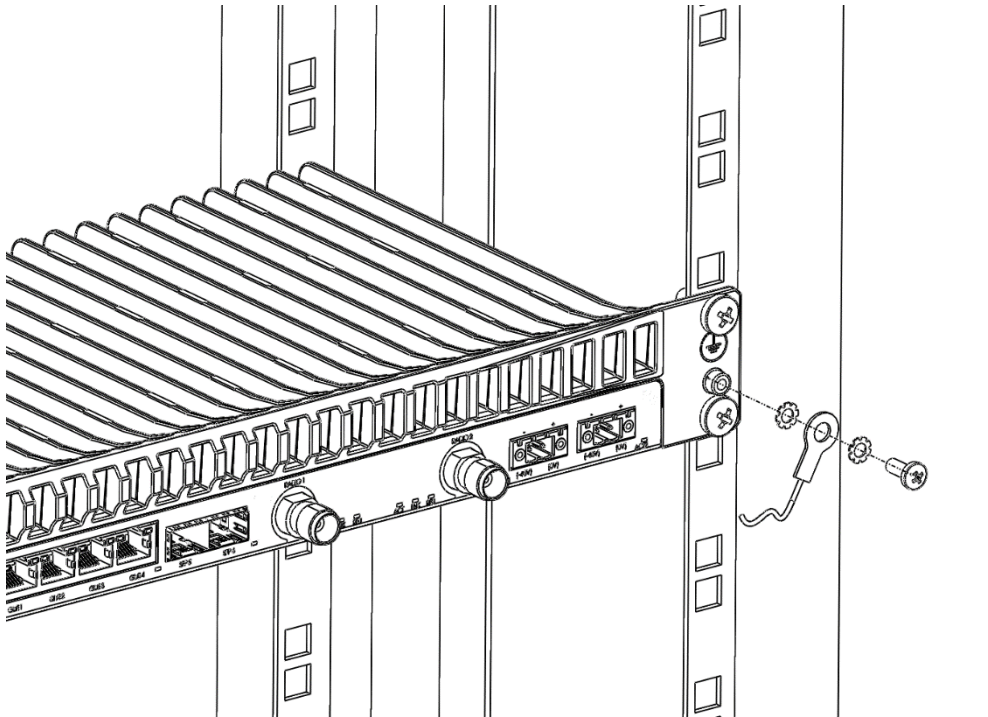

Chapter 5: Connecting Power Cable



Caution

Before connecting the power supply to the PTP 820G unit, you must verify that the positive pole in the external power supply is grounded! Power supply grounding must be in according with the following figure:

Figure 12 Power Supply Grounding

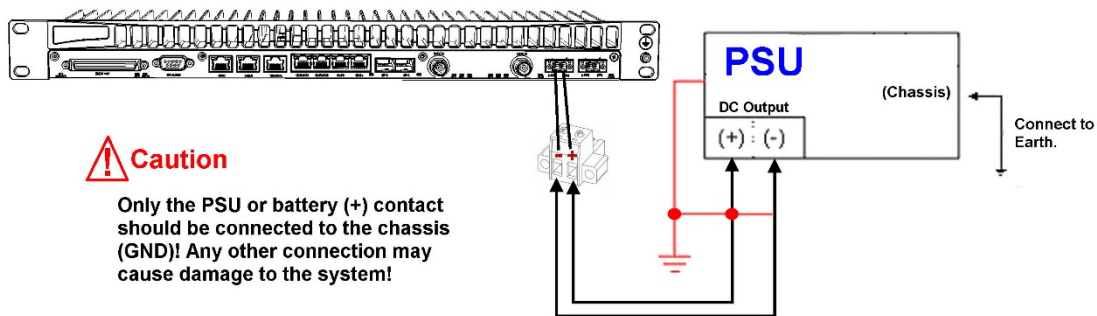

PTP 820G utilizes two power interface for power redundancy. A power cable connector is included with the PTP 820G unit.

To connect a power cable to the PTP 820G:

- 1 Expose the wires of the power cable.
- 2 Loosen the top two screws on the connector.
- 3 Verify that the wiring is according to the correct polarity.

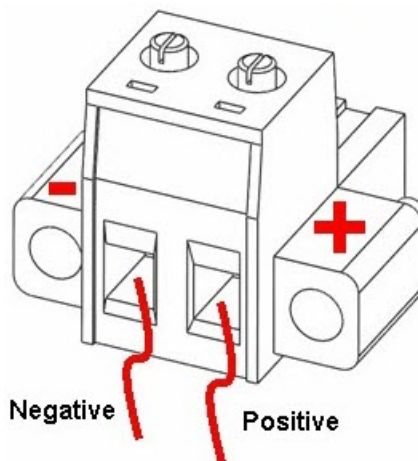

- 4 Insert the wires into the connector.
- 5 Secure the wires in the connector with the screws.
- 6 Plug the connector into the PTP 820G power interface and tighten the two screws on the sides of the connector to secure the connector.

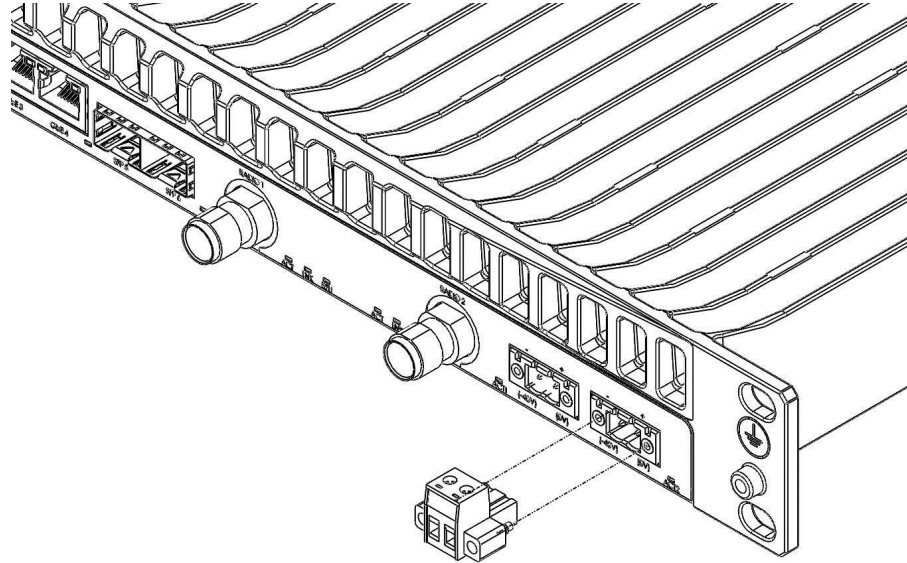

Power Supply Notes

When selecting a power source, the following must be considered:

- Voltage range: -40 VDC to -60 VDC.
- Recommended: Availability of a UPS (Uninterrupted Power Source), battery backup, and emergency power generator.
- The power source must be grounded.
- The unit has more than one supply connection - Remove all power from the unit for servicing.

**Warning**

Make sure to use a circuit breaker to protect the circuit from damage by short or overload. In a building installation, the circuit breaker shall be readily accessible and incorporated external to the equipment. The maximum rating of the overcurrent protection shall be 10 Amp, while the maximum current rating is 5 Amp.

Chapter 6: Cabling Requirements for Unit Redundancy

Cabling for Ethernet Interfaces

For Ethernet Splitter Mode, the following Y-cable must be connected to the relevant interfaces on the active and standby units:

Table 9 Y-Cable for Electrical Splitter Mode FE Traffic Interface Protection

Part Number	Description
C000082L153A	PTP 820G Fast Ethernet Protection Y-cable, 1.34m, Cat5E

No special cabling is required for other Ethernet protection modes.

Cabling for E1/DS1 Interfaces

If the E1/DS1 interfaces are being used, a Y-cable is used to connect the active and standby E1/DS1 interfaces. The following table shows the Part Number and Marketing Model of the Y-cable required for E1/DS1 protection.

Table 10 Y-Cable for E1/DS1 Protection

Part Number	Description
C000082L154A	PTP 820G TDM Protection Y cable, 0.6m,120 ohm

Cabling for T3 Synchronization

If T3 synchronization input is being used, a Y cable is used to connect to the active and standby Sync interfaces.

Inter-IDU Protection Connectivity and Management

PTP 820G units in a redundancy configuration must have their CPUs interconnected in order to synchronize their protection status. The same IP address is used for both PTP 820G units, to ensure that management is not lost in the event of switchover. A special cable is required to enable this connectivity.

Table 11 Splitter Cable for Protection and Management

Part Number	Description
C000082L155A	PTP820G Splitter cable for protection and management, 1.34m,CAT5E

The protection and management splitter cable must be connected to the management interfaces of the two PTP 820G units using the RJ-45 plug-ends. The third end of the protection splitter cable (RJ-45 socket) is connected to an external management station.

Figure 13 PTP 820G with Unit Redundancy – Protection and Management Connection

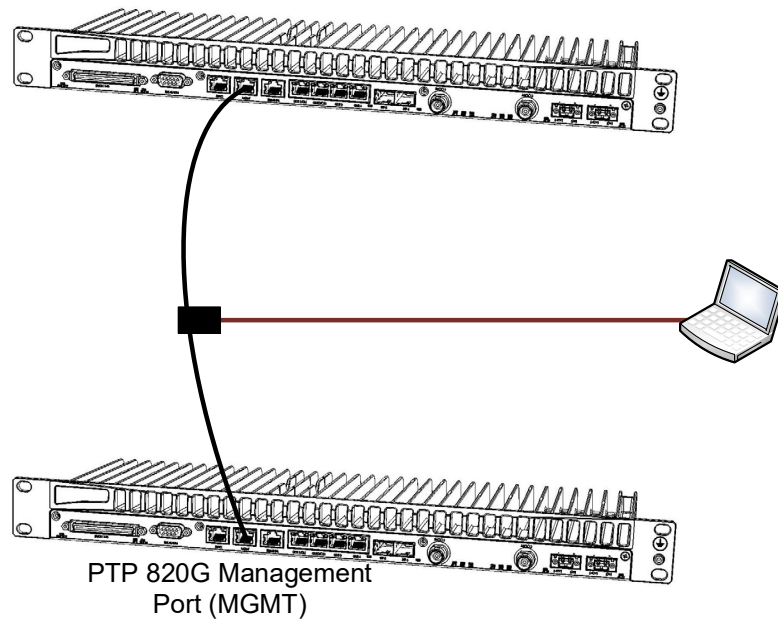

The local management connection uses PTP 820G management interface 1.

The inter-unit protection connection uses PTP 820G management interface 2.

Chapter 7: Performing Initial Configuration

This section describes how to establish a management connection with the PTP 820G unit and lists the configuration steps that must be performed in order to enable basic radio connectivity. For detailed configuration instructions, refer the PTP 820G User Guide.

Establishing a Connection

You can connect to the PTP 820G unit using a TP cable with a LAN connection or using a Serial RS-232 cable.

Connecting to the Unit with a Serial Connection

- 1 Connect an RS-232 cable with an RJ-45 interface from your laptop or PC to the Terminal Interface on the PTP 820G front panel.

Figure 14 Terminal Interface

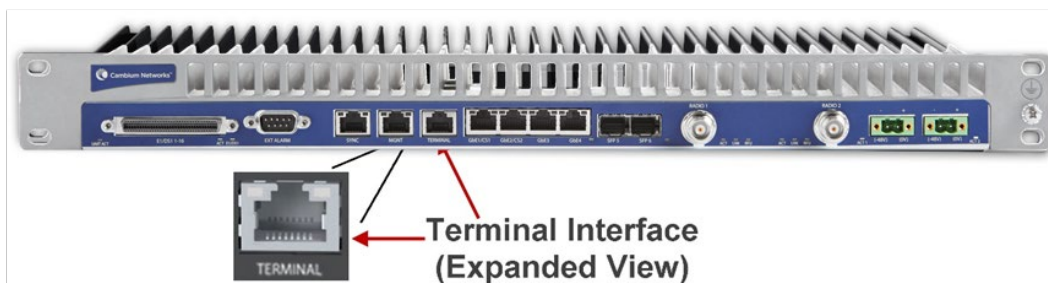

- 2 Configure the following settings for the COM port you are using on your PC or laptop:
 - Bits per Second – 115,200
 - Data Bits – 8
 - Parity – None
 - Stop Bits – 1
 - Flow Control - None

PTP 820G contains two FE management interfaces, which connect to a single RJ-45 physical connector on the front panel (MGMT). For details on which type of cable to use to utilize either one or both management interfaces, see [Management Interface Cable Options](#) on page 2-4.

Connect the cable to Management interface (MGMT) on the PTP 820G front panel, and to the LAN port on the PC.

Figure 15 Management Interface

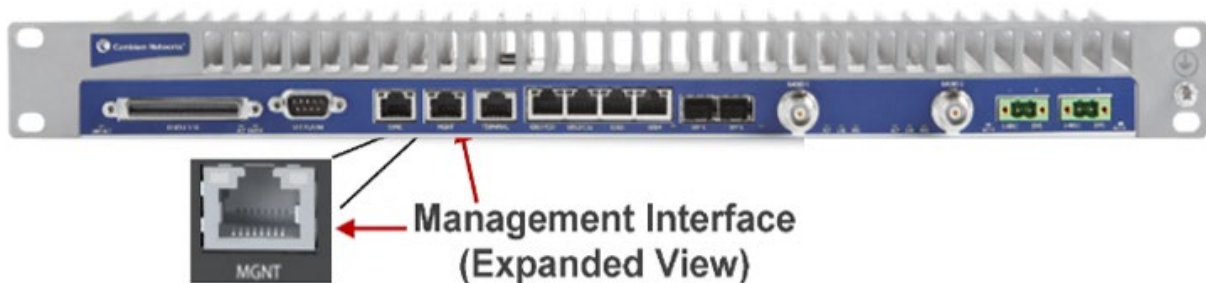

To establish a connection between the PC and the PTP 820G unit, it is necessary to have an IP address on the PC within the same subnet as the unit. The default IP address of the PTP 820G unit is 192.168.1.1. Set the PC address to e.g. 192.168.1.10 and subnet mask to 255.255.255.0.

**Note**

The initial settings before changing.

**Note**

The chassis IP address, as well as password must be changed before setting the system in operation. For more information on these procedures, see PTP 820G User Guide.

- 1 Select Control Panel > All Control Panel Items > Network and Sharing Center.
- 2 Click Change adapter settings.
- 3 Select Local Area Connection > Properties > Internet Protocol Version 4 (TCP/IP).
 - IP address: 192.168.1.10
 - Subnet mask 255.255.255.0
 - No default gateway
- 4 Press OK to apply the settings.

Logging On

- 1 Open a browser (e.g. Internet Explorer, Mozilla Firefox etc).
- 2 Type in the default IP address "**192.168.1.1**" in the Address Bar.

Login Window

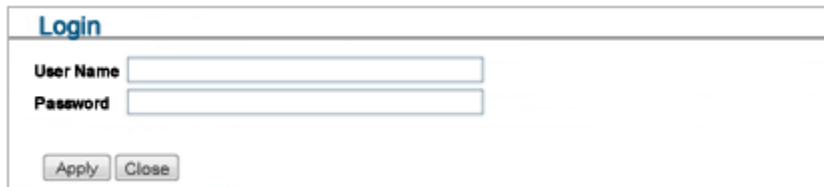

The screenshot shows a window titled "Login". Inside the window, there are two input fields: "User Name" and "Password". Below the input fields are two buttons: "Apply" and "Close".

- 3 Enter the following values:
User Name: **admin**
Password: **admin**
- 4 Click **Apply**.

Changing Your Password

It is recommended to change your default Admin password as soon as you have logged into the system.

To change your password:

1. Select Platform > Security > Access Control > Change Password. The Change User Password page opens.

Figure 16 Change User Password Page

2. In the Old password field, enter the current password. For example, upon initial login, enter the default password (admin).
3. In the New password field, enter a new password. If Enforce Password Strength is activated, the password must meet the following criteria:
 - Password length must be at least eight characters.
 - Password must include characters of at least three of the following character types: lower case letters, upper case letters, digits, and special characters. For purposes of meeting this requirement, upper case letters at the beginning of the password and digits at the end of the password are not counted.
 - The last five passwords you used cannot be reused.
4. Click Apply.

In addition to the Admin password, there is an additional password protected user account, “root user”, which is configured in the system. The root user password and instructions for changing this password are available from Cambium Networks Customer Support. It is strongly recommended to change this password.

Configuration

Before connection over the radio hop is established, it is of high importance that the elements are assigned a dedicated IP address, according to an IP plan for the total network.

**Note**

If connection over the hop is established with identical IP addresses, an IP address conflict will occur and remote connection to the element on the other side of the hop may be lost.

By default all elements have the same IP settings:

- IP address: 192.168.1.1
- Subnet mask: 255.255.255.0

**Note**

After the new IP address is set, the contact with the element will be lost. In order to reconnect, the PC must have an IP address within the same subnet as the element.

In addition to setting the IP addresses, the following configuration steps must be performed in order to establish basic connectivity. For a detailed description of these procedures, refer the *PTP 820G User Guide*.

- Enable the Radio Interfaces
- Set the Radio Frequencies
- Configure the License
- Unmute the Radio

Chapter 8: Specifications

Environmental Specifications for IDU

- Operating: ETSI EN 300 019-1-3 Class 3.2
- Temperature:
 - **-5°C (23°F) to 55°C (131°F)** – Temperature range for continuous operating temperature with high reliability.
 - **-25°C (-13°F) to 65°C (149°F)** – Temperature range for exceptional temperatures, tested successfully, with limited margins.



Note

Cold startup requires at least -5°C (23°F)
Humidity: 5%RH to 95%RH

Environmental Specifications for RFU

- Operating: ETSI EN 300 019-1-4 Class 4.1
- Temperature:
 - **-33°C (-27°F) to +55°C (131°F)** – Temperature range for continuous operating temperature with high reliability:
 - **-45°C (-49°F) to +60°C (140°F)** – Temperature range for exceptional temperatures; tested successfully, with limited margins:
- Humidity: 5%RH to 100%RH

Mechanical Specifications

Table 12 IDU Mechanical Specifications

IDU Dimensions	Height: 44 mm/1.73" (1RU) Width: 426 mm/16.77" Depth: 180 mm/7.08" Weight: 2.5 kg/5.5 lbs.
IDU-RFU Connection	Coaxial cable RG-223 (300 ft), Belden 9914/RG-8 (1000 ft) or equivalent, TNC connectors to the IDU, N-type connectors (male) to the RFU.

Table 13 RFU-C Mechanical Specifications

RFU-C Dimensions	Height: 200 mm/7.87"
	Width: 200 mm/7.87"
	Depth: 85 mm/3.35"
	Weight: 4kg/9 lbs.
RFU-C Standard Mounting OD Pole	50 mm-120 mm/2"-4.5" (subject to vendor and antenna size)

Power Consumption Specifications

The following table shows the maximum power consumption for PTP 820G IDU and supported RFUs. The maximum power consumption for the entire system is the sum of the IDU and the RFUs connecting to it.

Table 14 Power Consumption specifications

Configuration	Power (W)	Comments
IDU Eth-only with single RFU	23.5W	
Addition for second RFU	2.9W	
Addition for 16 E1s	11W	
RFU-C	1+0: 22	RFU only.
	1+1: 39	
	1+0: 26	RFU only.
	1+1: 43	

Chapter 9: Acceptance & Commissioning Procedures

This chapter provides Cambium Networks' recommended Acceptance and Commissioning Procedure for PTP 820. Acceptance and commissioning should be performed after initial setup is complete.

The purpose of this procedure is to verify correct installation and operation of the installed link and the interoperability with customer end equipment.

Cambium Networks' Acceptance and Commissioning procedure includes the following stages:

- Site Acceptance Procedure
- Commissioning of radio link

The Site Acceptance Procedure is a checklist that summarizes the installation requirements of the site at which the products were installed.

The commissioning tests cover the required configuration information that should be recorded, and the tests that should be performed on the radio link.

Site Acceptance Procedure

The purpose of the following procedures is to verify that all installation requirements were noted and checked.

Following this procedure will ensure proper, long-lasting, and safe operation of the product.

The checklist below summarizes the installation requirements of the site.

SITE ACCEPTANCE CHECKLIST	
1. SITE INFORMATION	
Customer:	
Radio model:	
Site name:	
Site code:	
Radio link code:	
Site address:	
2. ANTENNA MOUNTING	
Antenna mount type:	
Mount is of sufficient height to clear local obstructions	OK
Mount is safely positioned to not cause a safety hazard	OK
Mount is secure and perpendicular	OK
Mount is grounded as per site specifications	OK
All steelwork is Galvanized or Stainless Steel as appropriate	OK
SITE ACCEPTANCE CHECKLIST (continued)	
3. ANTENNA	
Antenna type (model and size):	
Antenna is securely fixed to mount	OK
Antenna is grounded as per site specifications	OK
Antenna sway braces are installed correctly (where applicable)	OK
Antenna Radome is securely fitted (where applicable)	OK
Water drain plugs are fitted and removed, as appropriate	OK
Antenna sealing O-Ring is properly fitted and not damaged	OK
Antenna/Launch unit polarization is as per link requirements	OK
4. RADIO FREQUENCY UNIT (RFU)	

Type of RFU mount:	(Direct or Remote mount)
RFU is securely mounted to the antenna or pole	OK
RFU is grounded as per installation instructions	OK
RFU's polarization is as per link requirements	OK
RFU is installed properly and has no physical damage	OK
<i>For Remote-Mount Only:</i>	
Remote mount kit is securely mounted to the pole	OK
Flexible waveguide has no physical damage and connectors are sealed	OK
All flexible waveguide bolts are secured using washers and lock-washers, as appropriate	OK
Flexible waveguide is secured to the pole	OK
5. COAX CABLE	
Overall cable length:	
Cable type:	
N-Type connectors assembled properly on the cable	OK
Cable connected securely to RFU and IDU	OK
Cable connector is weather-proofed (sealed) at the RFU	OK
At the RFU, cable has a service/drip loop to prevent moisture from entering the connector	OK
Cable is secured using suitable restraints to fixed points at regular intervals (0.5 m recommended)	OK
Cable has no sharp bends, kinks, or crushed areas. All bends are per manufacturer specifications	OK
Grounding/lightning protection is as per site specifications	OK
Lightning protection type and model:	
Cable point-of-entry to building/shelter is weather-proof	OK
Cable ends are properly labeled	OK

SITE ACCEPTANCE CHECKLIST (continued)	
6. FLEXIBLE WAVEGUIDE	
Overall flexible WG length:	
Flexible WG type:	
Flexible WG is connected securely to RFU and Antenna	OK
Flexible WG connector is weather-proofed (sealed) at the RFU	OK
At the RFU, the flexible WG has a service/drip loop to prevent moisture from entering the connector	OK
Flexible WG is secured using suitable restraints to fixed points at regular intervals (0.5 m recommended)	OK
Flexible WG has no sharp bends, kinks, or crushed areas. All bends are per manufacturer specifications	OK
Flexible WG point-of-entry to building/shelter is weather-proof	OK
Flexible WG ends are properly labeled	OK
7. INDOOR UNIT	
IDU is securely mounted to the rack	OK
IDU is located in a properly ventilated environment	OK
IDU fans are functional and air flow to the fans is not disrupted	OK
IDU and rack are grounded as per site specifications	OK
Traffic cables and connections are properly terminated as per manufacturer/cable instructions	OK
All cabling is secured, tidy, and visibly labeled	OK
8. DC POWER SUPPLY - Two Inputs	
Measured DC voltage input to the IDU:	(-40.5 to -60 VDC)
Power-Supply maximum current:	(at least 3 Ampere per carrier)
Power-Supply is properly grounded	OK
DC power backup type:	
IDU DC connector is secure and the DC input leads are correctly terminated (no bare wires are visible)	OK
IDU DC connector (+) and (GND) leads are shorted and GND is grounded	OK
9. RACK INSTALLATION	
Rack is mounted to the shelter floor with four screws	OK
Rack is mounted to the shelter wall with two screws	OK

SITE ACCEPTANCE CHECKLIST (continued)	
10. REMARKS/NOTES	
11. GENERAL INFORMATION	
Site accepted by:	Name:
	Title:
	Company:
	Signature:
	Date:
Site approved by:	Name:
	Title:
	Company:
	Signature:
	Date:

Site Acceptance Checklist Notes

The following notes provide important additional information about the Site Acceptance Checklist.

1. Antenna Mounting

- Mounting pole is of sufficient height to clear local obstructions, such as parapets, window cleaning gantries, and lift housings.
- Mounting Pole is of sufficient height, and is safely positioned, so as not to cause a safety hazard. No person should be able to walk in front of, or look directly into the path of the microwave radio beam. Where possible, the pole should be away from the edge of the building.
- Mounting pole is secure and perpendicular. A pole that is not perpendicular may cause problems during antenna alignment.
- Mounting pole is grounded as per site specifications. All operators and site owners have specific requirements regarding the grounding of installations. As a minimum, typical requirements are such that any metal structure must be connected to the existing lightning protection ground of the building. Where it extends beyond the 45 degree cone of protection of existing lightning conductors, additional lightning protectors should be installed.
- All steelwork is Galvanized or Stainless Steel, as appropriate to prevent corrosion.

2. Antenna

- Antenna is grounded as per site specifications. See the third point in the Antenna Mounting section above.
- Antenna sway braces are fitted and installed correctly, where applicable. Typically, for an antenna of 1.2 m or larger, an extra sway brace is fitted to the mounting frame of the antenna. This sway brace should not be mounted to the same pole as the antenna, but should be installed directly back to the tower or an alternative point.
- Antenna Water Drain Plugs are fitted and removed, where appropriate. Some antennas have moisture drain plugs installed at various points around the antenna. The purpose of these plugs is to allow any moisture that forms on the inside of the antenna or radome to drip out and prevent a pool within the antenna. Only the plugs at the bottom of the antenna, after installation, should be removed. All other plugs should be left in position.

3. RFU (Outdoor Unit)

- The RFU is grounded as per installation instructions. See the third point in the Antenna Mounting section above.
- The RFU polarization is as per link requirements and matches the polarization of the antenna.

4. Indoor Unit

- The main traffic connections are correctly terminated and crimped as per cable and connector manufacturer instructions. All fiber optic patch leads should be routed carefully and efficiently, using conduits to prevent damage to the cables.
- All other user terminations are secure and correctly terminated.
- All labeling is complete as per site requirements. Labeling is specific to each customer. At a site with only one installation, labeling may be unnecessary. However, at sites with multiple installations, correct and adequate labeling is essential for future maintenance operations.

Typical labeling requirements include:

- Antenna labels - for link identity and bearing

- RFU labels - for link identity, frequency, and polarization
- Coax cable labels - for link identity, close to the RFU, IDU, and either end of any joint
- IDU labels - for link identity

Radio Link Commissioning Procedure

Scope

This section describes the recommended commissioning tests for PTP 820 radio link in a 1+0 configuration. The purpose of the commissioning tests is to verify correct and proper operation of the product.

Commissioning Test

The following tests should be performed on each installed link.

Link Verification

- Received Signal Level (RSL) is up to +/- 4 dB from the expected (calculated) level at both ends of the link.
- Radio Bit Error Rate (BER) is 10E-11 or lower.
- If working with ATPC, ATPC is operating as expected (RSL = reference level).

Ethernet Line Interfaces Test

- Connect Ethernet Packet Analyzer to the GbE port. Use physical loop at remote end (or connect second analyzer). Run Packet Loss test for at least one hour (load rate as per Cambium Networks' specifications for the chosen MRMC).
- Connect Ethernet Packet Analyzer to the FE port. Use physical loop at remote end (or connect second analyzer). Run Packet Loss test for at least one hour (load rate as per Cambium Networks' specifications for the chosen MRMC).

Interoperability Verification

- Connect customer end equipment to the line interfaces, and verify correct operation.
- Further interoperability tests should be performed in accordance with the specific requirements of the connected end equipment.

Management Verification

- Launch the HTTP management and verify that you can manage the link and that you are able to perform changes to the link configuration (frequency channel, Tx power, system name, time & date, etc.)
- Verify that correct parameters are reported when performing the above.
- Verify that there are no active alarms on the link.
- If the management station is located at a remote site (Network Operation Center), verify that the management station can manage the link and receive traps.

PTP 820 Commissioning Log

The Commissioning Log is an integral part of the commissioning procedure and should be filled in for each installed link.

The Commissioning Log gathers all relevant information regarding the installed link and contains a checklist of all recommended commissioning tests.

Maintaining the Commissioning Log is important for tracking your installations, and to provide essential data for Cambium Networks.

Upon completing the Commissioning Log, send the log to Cambium Networks' support center at support@cambium.com.

PTP 820 LINK COMMISSIONING LOG		
1. GENERAL INFORMATION		
Customer:		
Radio model:		
Configuration:		
Radio link code:		
Site 1 name & add:		
Site 2 name & add:		
2. RFU	Site 1	Site 2
RFU model:		
RFU p/n:		
RFU s/n:		
RFU SW:		
IDU model:		
IDU p/n:		
IDU s/n:		
IDU SW:		
Tx frequency (MHz):		
Rx frequency (MHz):		
Link ID:		
Tx power (dBm):		
ATPC on/off:		
ATPC ref level:		
RFU Polarization:		

3. ANTENNA AND RFU MOUNT	Site 1	Site 2
Antenna vendor and model:		
Antenna size:		
Mounting type:		
Mounting losses:		
4. LINK PARAMETERS	Site 1	Site 2
Link distance:		
Rain zone:		
Expected RSL (dBm):		
Expected Diversity RSL (dBm):		
RSL Main (dBm):		
RSL Diversity (dBm):		
Deviation from exp?		
RSL \leq 4 dB?		
5. COMMISSIONING TESTS	Site 1	Site 2
Line loopback:	Pass	Pass
RFU loopback:	Pass	Pass
Radio BER:	Pass	Pass
FE test:	Pass	Pass
GbE test:	Pass	Pass
6. MANAGEMENT CONFIGURATION	Site 1	Site 2
Eth IP Address:		
Eth IP mask:		
Default router:		
In-band VLAN		
7. REMARKS/NOTES		
8. INSTALLATION INFORMATION		
Installed by:	Name:	
	Company:	
	Date:	

	Signature:
Commissioned by:	Name:
	Company:
	Date:
	Signature: