



QUICK START GUIDE

cnMaestro c4000 Controller



Accuracy

While reasonable efforts have been made to assure the accuracy of this document, Cambium Networks assumes no liability resulting from any inaccuracies or omissions in this document, or from use of the information obtained herein. Cambium Networks reserves the right to make changes to any products described herein to improve reliability, function, or design, and reserves the right to revise this document and to make changes from time to time in content hereof with no obligation to notify any person of revisions or changes. Cambium Networks does not assume any liability arising out of the application or use of any product, software, or circuit described herein; neither does it convey license under its patent rights or the rights of others. It is possible that this publication may contain references to, or information about Cambium Networks products (machines and programs), programming, or services that are not announced in your country. Such references or information must not be construed to mean that Cambium Networks intends to announce such Cambium Networks products, programming, or services in your country.

Copyrights

This document, Cambium Networks products, and 3rd Party software products described in this document may include or describe copyrighted Cambium Networks and other 3rd Party supplied computer programs stored in semiconductor memories or other media. Laws in the United States and other countries preserve for Cambium Networks, its licensors, and other 3rd Party supplied software certain exclusive rights for copyrighted material, including the exclusive right to copy, reproduce in any form, distribute and make derivative works of the copyrighted material. Accordingly, any copyrighted material of Cambium Networks, its licensors, or the 3rd Party software supplied material contained in the Cambium Networks products described in this document may not be copied, reproduced, reverse engineered, distributed, merged or modified in any manner without the express written permission of Cambium Networks. Furthermore, the purchase of Cambium Networks products shall not be deemed to grant either directly or by implication, estoppel, or otherwise, any license under the copyrights, patents or patent applications of Cambium Networks or other 3rd Party supplied software, except for the normal non-exclusive, royalty free license to use that arises by operation of law in the sale of a product.

Restrictions

Software and documentation are copyrighted materials. Making unauthorized copies is prohibited by law. No part of the software or documentation may be reproduced, transmitted, transcribed, stored in a retrieval system, or translated into any language or computer language, in any form or by any means, without prior written permission of Cambium Networks.

License Agreements

The software described in this document is the property of Cambium Networks and its licensors. It is furnished by express license agreement only and may be used only in accordance with the terms of such an agreement.

High Risk Materials

Cambium and its supplier(s) specifically disclaim any express or implied warranty of fitness for any high risk activities or uses of its products including, but not limited to, the operation of nuclear facilities, aircraft navigation or aircraft communication systems, air traffic control, life support, or weapons systems (“High Risk Use”). Any High Risk is unauthorized, is made at your own risk and you shall be responsible for any and all losses, damage or claims arising out of any high risk use.

Introduction

Thank you for purchasing Cambium Networks cnMaestro c4000 Controller. This Quick Start Guide is provided to assist operators in acquiring a high-level understanding of the cnMaestro c4000 Controller hardware, installation methods, initial login procedures, and safety/warranty information.



Product Description

cnMaestro c4000 Controller is On-Premises hardware appliance for onboarding, management and monitoring of Cambium products and can be used as a GRE tunnel concentrator for cnPilot device.

Product Safety information







Warning

To prevent loss of life or physical injury, observe the following safety guidelines. In no event shall Cambium Networks be liable for any injury or damage caused during the installation of cnMaestro c4000 Controller platform. Ensure that only qualified personnel install.

Electrical Safety Information

1. Compliance with manufacturer's label for voltage, frequency, and current requirements. Connecting to a different power source than those specified may result in improper operation, damage to equipment or pose a fire hazard if the limitations are not followed.
2. There are no serviceable parts inside this equipment. Service should be provided only by a qualified service technician.
3. This equipment is provided with a detachable power cord which has an integral safety ground wire intended for connection to a grounded safety outlet.
 - a. Do not substitute the power cord with one that is not the provided approved type. Never use an adapter plug to connect to a 2-wire outlet as this will defeat the continuity of the grounding wire.
 - b. The equipment requires the use of the ground wire as a part of the safety certification, modification or misuse can provide a shock hazard that can result in serious injury or death.
 - c. Contact a qualified electrician or the manufacturer if there are questions about the installation prior to connecting the equipment.
 - d. Protective earthing is provided by Listed AC adapter. Building installation shall provide appropriate short-circuit backup protection.
 - e. Protective bonding must be installed in accordance with local national wiring rules and regulations.

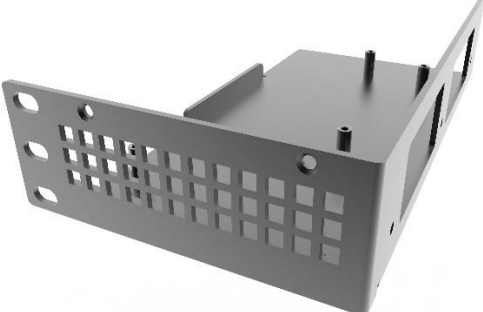
Package Contents



SL No.	Item	Image
1	c4000 Controller	 <p>The image shows the CamBium cnMaestro c4000 Controller, a black, rectangular device. On the front panel, there are several ports and indicators: a power button, a storage indicator light, a status indicator light, a reset button, and a console port. The CamBium logo and 'cnMaestro c4000' are printed on the front.</p>
2	Adapter Top cover	 <p>The image shows the Adapter Top cover, a black, rectangular metal component with a central cutout and mounting tabs on the sides.</p>
3	Left side Mounting Bracket	 <p>The image shows the Left side Mounting Bracket, a black metal component with a grid of ventilation holes on the front and mounting tabs on the sides.</p>
4	Right Side Mounting Bracket	 <p>The image shows the Right Side Mounting Bracket, a black metal component with a grid of ventilation holes on the front and mounting tabs on the sides.</p>
5	Console Cable	 <p>The image shows the Console Cable, a black cable with a RJ45 connector on one end and a DB9 connector on the other.</p>

SL No.	Item	Image
6	Ethernet Cable	
7	M2 Screws (Qty. 11)	
8	M3 CSK Screw (Qty.12)	
9	Power Adapter	

Mounting Instructions

Rack Mount

<p>Step 1:</p> <p>Fix the right-side mounting bracket to cnMaestro c4000 Controller using 3x M2 screws.</p>	
---	--

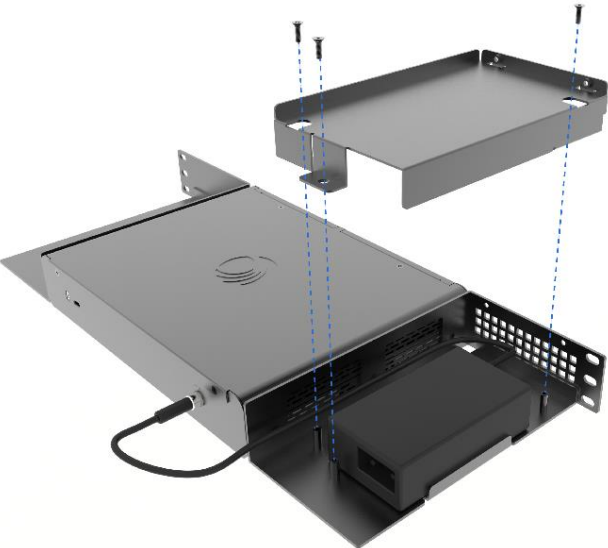
<p>Step 2: Fix the Left-side mounting bracket to cnMaestro c4000 Controller using 3x M2 screws.</p>	
<p>Step 3: Place the power adapter on the Left-side mounting bracket.</p>	
<p>Step 4: Place the adapter top cover on the Left-side mounting bracket holding the power adaptor inside by using 3x M2 screws from the top.</p>	

Step 5:

Using 2x M2 screws, assemble the adaptor top cover to the Left-side mounting bracket from the front as shown in figure.



Step 6:

If you are using a universal 19-inch cabinet, snap a TAR M6 square cage nut into the top and bottom holes of the location where you will be installing the rail plate as shown.



cnMaestro c4000 Controller Hardware Overview

cnMaestro c4000 Controller interfaces overview

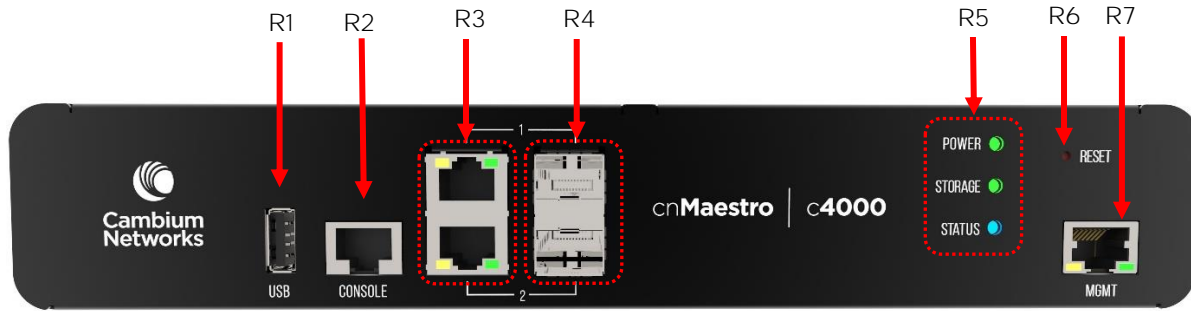

Figure 1: cnMaestro c4000 Controller Front View

Item	Component	Qty
R1	USB 2.0 Type A Port	1
R2	Console Port	1
R3	1 Gigabit Ethernet Interfaces (Data Port)	2
R4	1 Gigabit SFP Ports (Data Port)	2
R5	Multi-purpose LEDs	3
R6	Reset Button	1
R7	Management Port	1



Figure 2: cnMaestro c4000 Controller Back View

Item	Component	Qty
R8	Kensington Lock	1
R9	DC Power In	1

cnMaestro c4000 Controller LED details

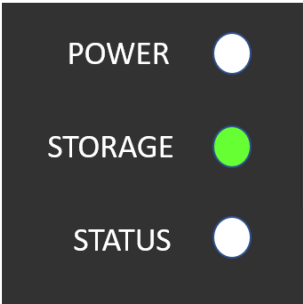
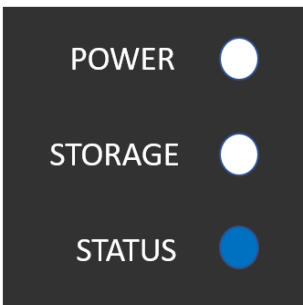
LED Name	LED	Color	Behaviour	Status Indication
Power		Green	Steady On	Power On
Storage		Green	Blinking	Represents Storage Activity
Status		Amber	Steady On	Device is booting state
		Blue	Steady On	Successful boot of device
		Blue and Amber	Blinking	Factory Reset in progress

cnMaestro c4000 Controller Reset

Action	Behaviour
Press and Release	Reboot
Press and Hold for 10 seconds	Factory reset

cnMaestro c4000 Controller Specifications

Category	Specification
Power Supply	115vac/230VAC
MTBF (Hours)	320,415 hours (GB, 30C)
Weight	2.3 kg
Dimensions	255mm x 191.2 mm x 44 mm
CPU Speed	C2758, 2.4GHz
Rack Mountable	Yes
Temperature Ranges	0 - 40C
Operating Humidity	95%@40C
Storage Temperature	-20°C to - 80°C
Memory	8GB
CPU Cores	8

Initial Setup and Software Upgrade

Power ON the cnMaestro c4000 Controller. POWER LED will glow after powering ON and wait for 2 minutes to boot up the device properly.

- The controller comes with a default factory image.
- To upgrade the controller with latest software image, setup the management port connectivity as shown below:

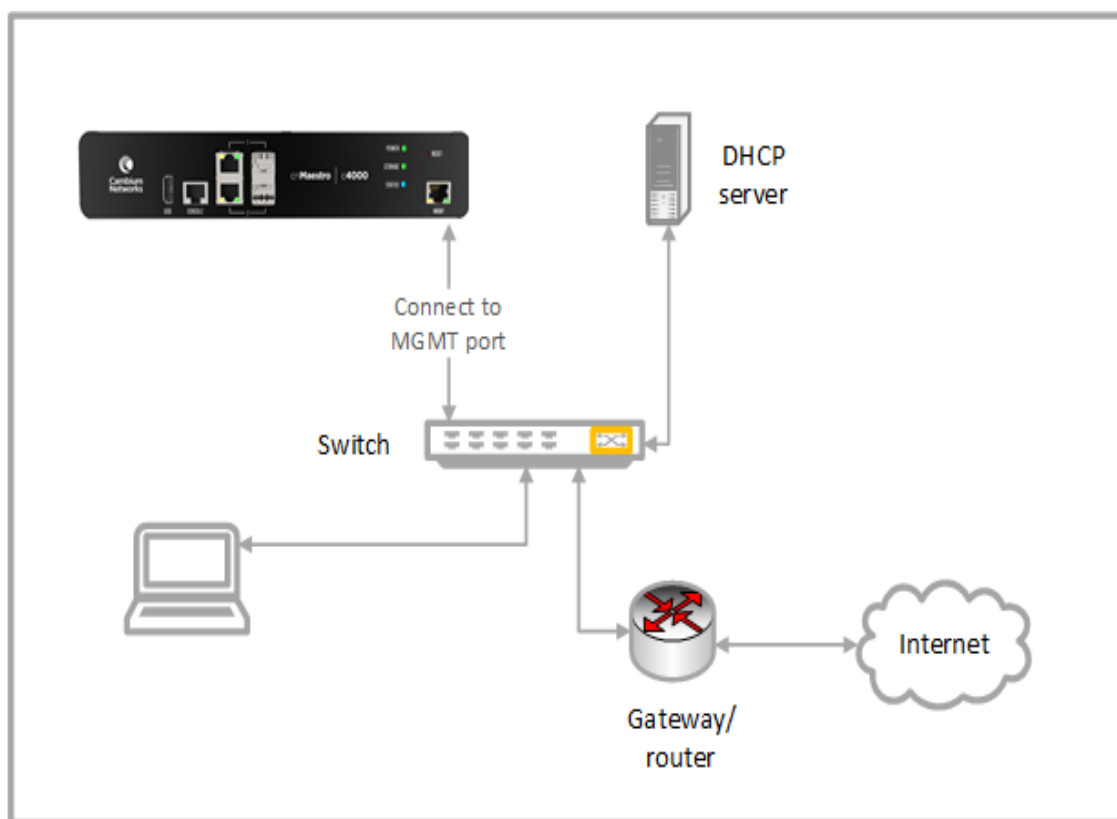

Figure 3: Installing cnMaestro c4000 Controller

Login to Web UI

- Open the browser and login to controller UI as `http(s)://<IP address>` with default credentials as below:
 - Username: admin
 - Password: admin



Note

cnMaestro c4000 Controller will try to get a DHCP IP. In case of DHCP failure the default fallback IP is 192.168.0.1.

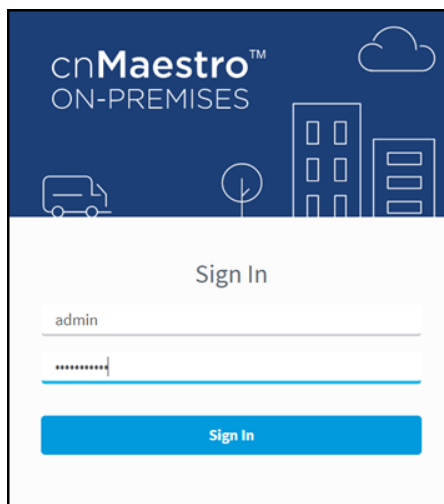

Configure country

After login a pop-up window will appear to configure country. This is mandatory to continue configuring system as per the requirements.

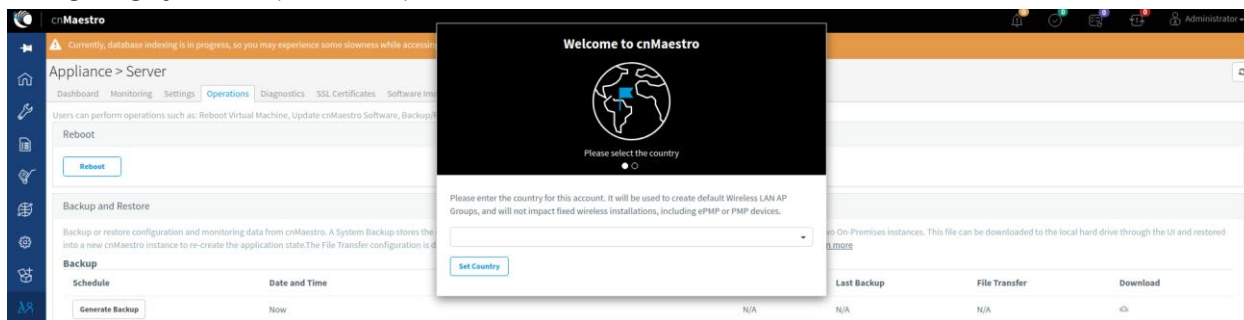

Change default password

After login, a window will appear prompting the user to change default password.

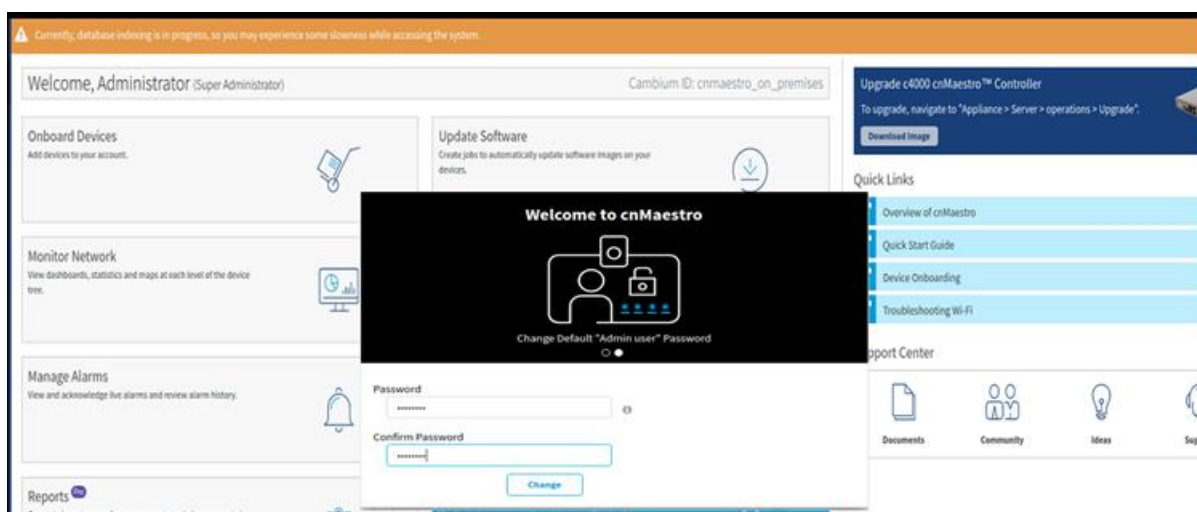

Login to web UI with new password

It will redirect to login page again. Login with default username and new password.

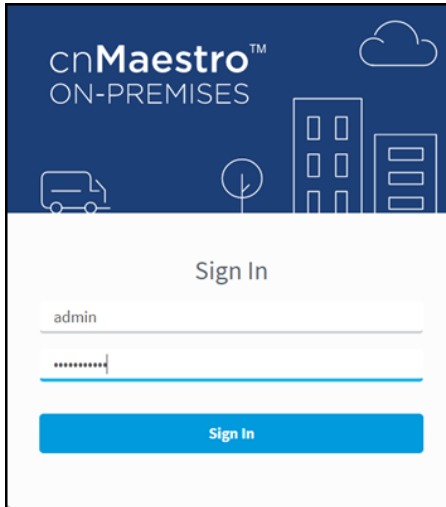

Default software version



Note

The default software version on the cnMaestro c4000 controller is 1.0-a30.

To view the default software version in the UI:

Navigate to Appliance > Server > Operations page. You can view the active partition of controller showing version as 1.0-a30 on the bottom of the page.

Software upgrade

1. Navigate to the home page of cnMaestro c4000 controller UI.

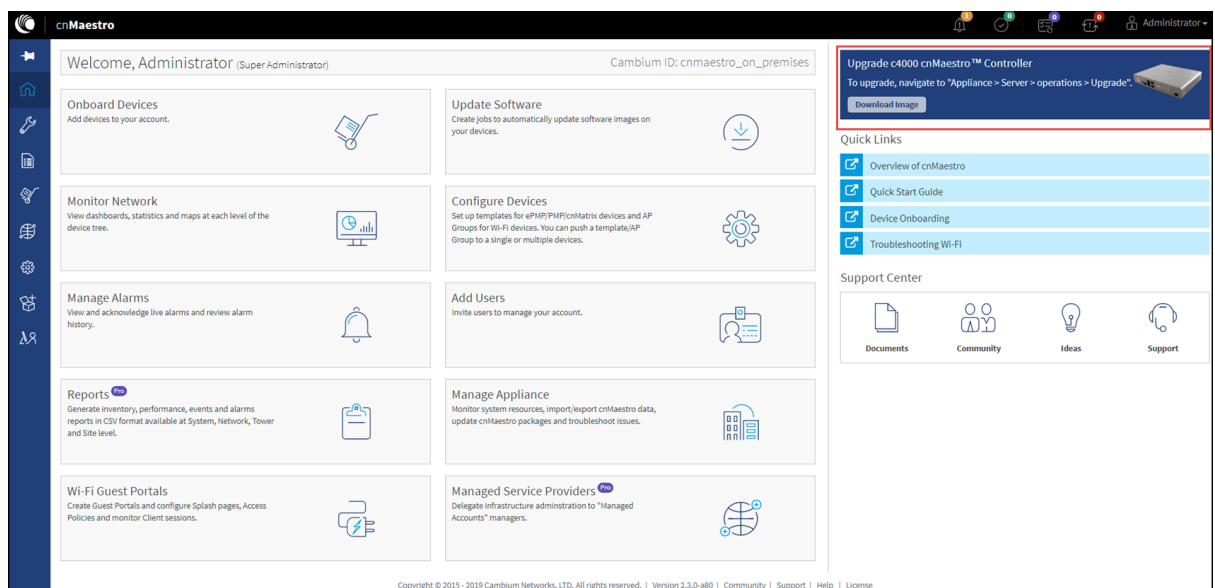

2. Click on Download Image button.

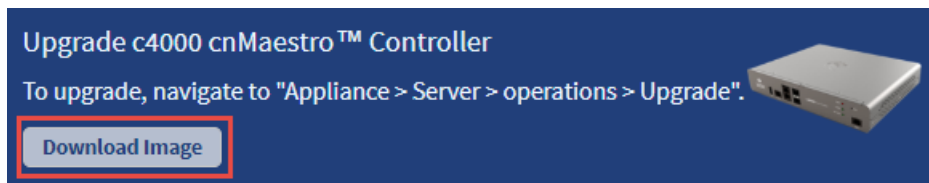

It directs user to Cambium Support page. The user can login to the Support Site and download the cnMaestro c4000 Controller image.

3. Once the download is complete, navigate to Appliance > Server > Operations page in the UI.
4. Navigate to File and click Copy File button.

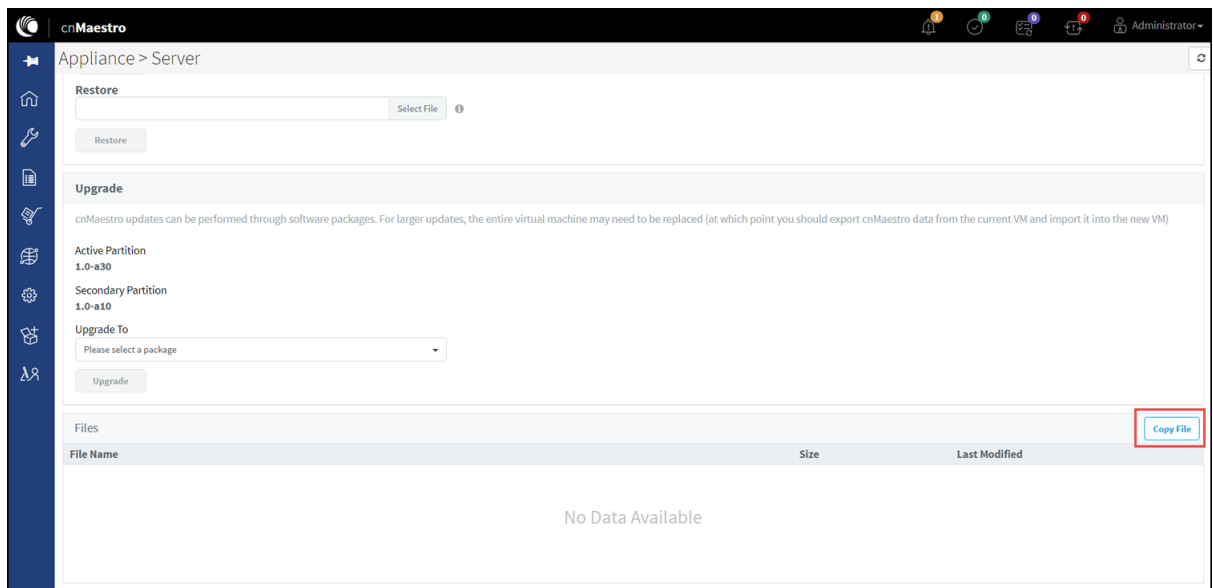

5. Copy File window will pop-up. Choose Local radio button.

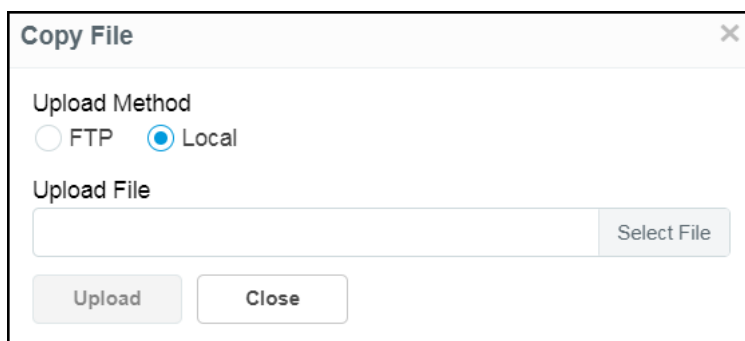

6. Click Select File to browse and select the downloaded cnMaestro c4000 Controller image.

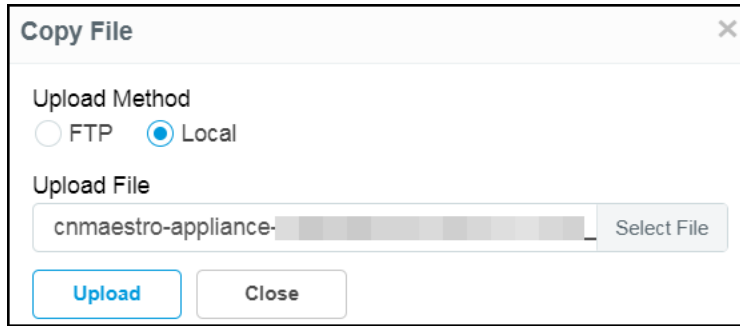

7. Click Upload button to upload the selected cnMaestro c4000 Controller image.

You can view the status of upload in the UI as displayed below:

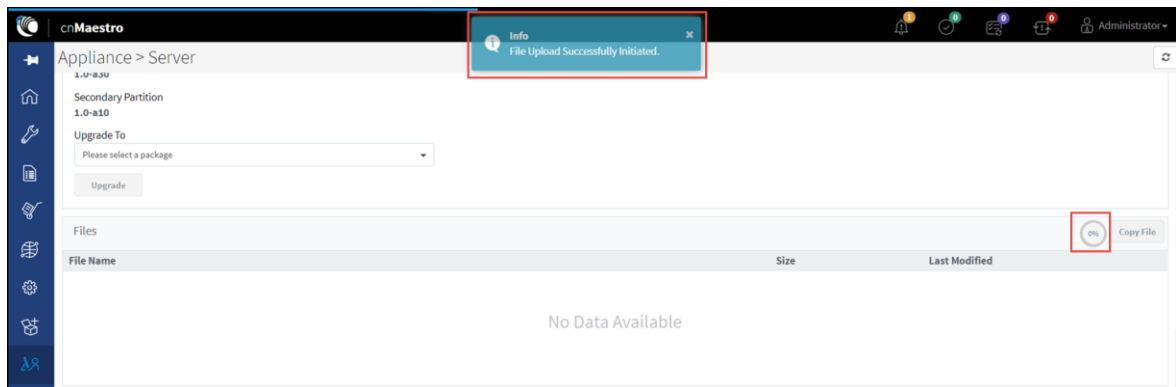

8. Once the upload is successful, the cnMaestro c4000 Controller image file will be displayed under File Name in the UI.

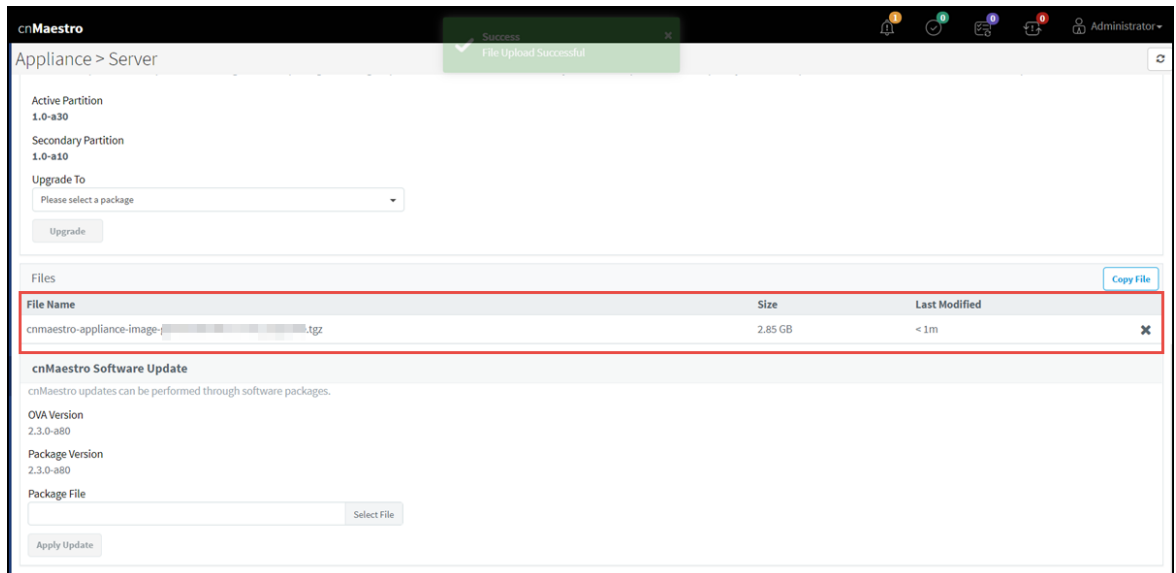

9. Under Upgrade, choose the uploaded cnMaestro c4000 Controller image from the drop-down list.

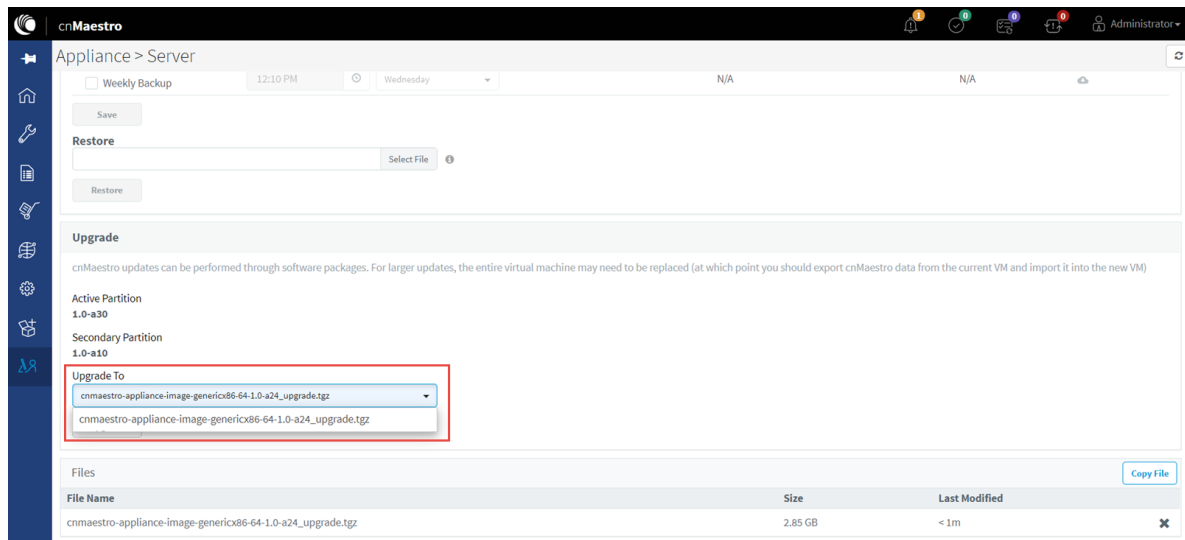

10. Click Upgrade button.

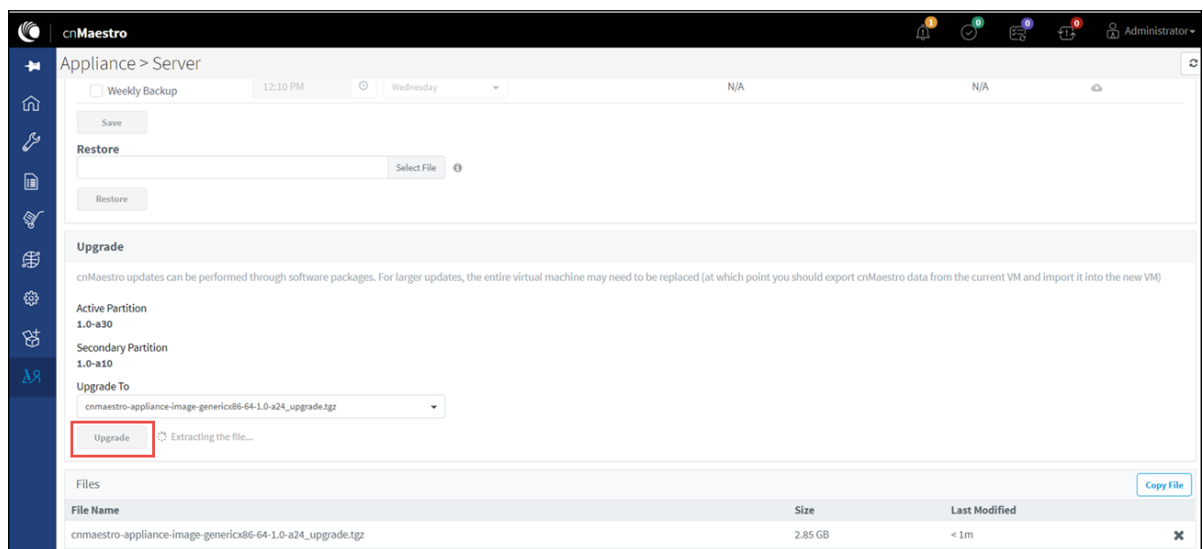

11. You can also view the status of upgrade as shown below:

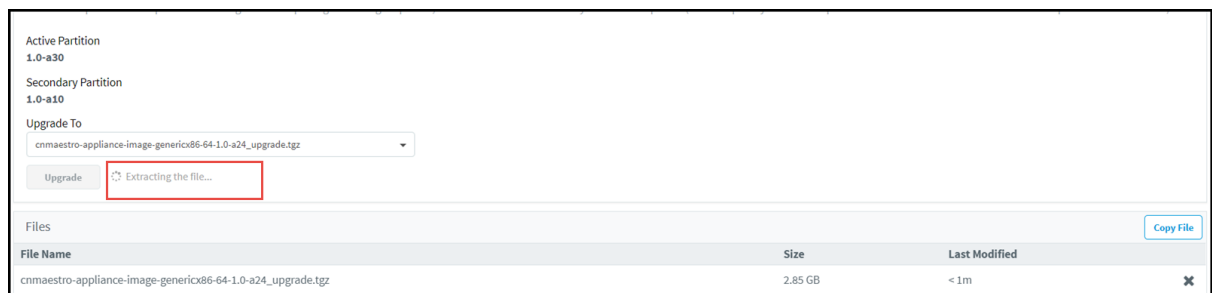

12. Once the upgrade is successful, click on the link next to Upgrade button for rebooting the device.

cnMaestro

Appliance > Server

Weekly Backup 12:23 PM Wednesday N/A N/A

Save

Restore Select File

Restore

Upgrade

cnMaestro updates can be performed through software packages. For larger updates, the entire virtual machine may need to be replaced (at which point you should export cnMaestro data from the current VM and import it into the new VM)

Active Partition
1.0-a30

Secondary Partition
1.0-a10

Upgrade To
cnmaestro-appliance-image-generic86-64-1.0-a30_upgrade.tgz

Upgrade Upgrade process has been completed. [Reboot](#) the device.

Files [Copy File](#)

File Name	Size	Last Modified
extract	4.00 KB	0d 0h 2m
cnmaestro-appliance-image-generic86-64-1.0-a30_upgrade.tgz	2.68 GB	< 1m

Cambium Networks

Cambium Networks provides professional grade fixed wireless broadband and microwave solutions for customers around the world. Our solutions are deployed in thousands of networks in over 153 countries, with our innovative technologies providing reliable, secure, cost-effective connectivity that’s easy to deploy and proven to deliver outstanding performance.

Our award-winning Point to Point (PTP) radio solutions operate in licensed, unlicensed and defined use frequency bands including specific FIPS 140-2 solutions for the U.S. Federal market. Ruggedized for 99.999% availability, our PTP solutions have an impeccable track record for delivering reliable high-speed backhaul connectivity even in the most challenging non-line-of-sight RF environments.

Our flexible Point-to-Multipoint (PMP) solutions operate in the licensed, unlicensed and federal frequency bands, providing reliable, secure, cost effective access networks. With more than three million modules deployed in networks around the world, our PMP access network solutions prove themselves day-in and day-out in residential access, leased line replacement, video surveillance and smart grid infrastructure applications.

Cambium Networks solutions are proven, respected leaders in the wireless broadband industry. We design, deploy and deliver innovative data, voice and video connectivity solutions that enable and ensure the communications of life, empowering personal, commercial and community growth virtually everywhere in the world.

User Guides	https://support.cambiumnetworks.com/files
Technical training	https://learning.cambiumnetworks.com
Support website	https://www.cambiumnetworks.com/support/
Main website	http://www.cambiumnetworks.com
Sales enquiries	solutions@cambiumnetworks.com
Support enquiries	https://support.cambiumnetworks.com
Telephone number list	http://www.cambiumnetworks.com/contact-us/
Address	Cambium Networks Limited, Linhay Business Park, Eastern Road, Ashburton, Devon, TQ13 7UP United Kingdom



www.cambiumnetworks.com

Cambium Networks and the stylized circular logo are trademarks of Cambium Networks, Ltd. All other trademarks are the property of their respective owners.