



USER GUIDE

cnPilot Home Router

System Release 4.7.2



## **Accuracy**

Cambium reserves the right to make changes to any products described herein to improve reliability, function, or design, and reserves the right to revise this document and to make changes from time to time in content hereof with no obligation to notify any person of revisions or changes. Cambium recommends reviewing the Cambium Networks website for the latest changes and updates to products. Cambium does not assume any liability arising out of the application or use of any product, software, or circuit described herein; neither does it convey license under its patent rights or the rights of others. It is possible that this publication may contain references to, or information about Cambium products (machines and programs), programming, or services that are not announced in your country. Such references or information must not be construed to mean that Cambium intends to announce such Cambium products, programming, or services in your country.

## **Copyrights**

This document, Cambium products, and 3<sup>rd</sup> Party software products described in this document may include or describe copyrighted Cambium and other 3<sup>rd</sup> Party supplied computer programs stored in semiconductor memories or other media. Laws in the United States and other countries preserve for Cambium, its licensors, and other 3<sup>rd</sup> Party supplied software certain exclusive rights for copyrighted material, including the exclusive right to copy, reproduce in any form, distribute and make derivative works of the copyrighted material. Accordingly, any copyrighted material of Cambium, its licensors, or the 3<sup>rd</sup> Party software supplied material contained in the Cambium products described in this document may not be copied, reproduced, reverse engineered, distributed, merged or modified in any manner without the express written permission of Cambium. Furthermore, the purchase of Cambium products shall not be deemed to grant either directly or by implication, estoppel, or otherwise, any license under the copyrights, patents or patent applications of Cambium or other 3<sup>rd</sup> Party supplied software, except for the normal non-exclusive, royalty free license to use that arises by operation of law in the sale of a product.

## **Restrictions**

Software and documentation are copyrighted materials. Making unauthorized copies is prohibited by law. No part of the software or documentation may be reproduced, transmitted, transcribed, stored in a retrieval system, or translated into any language or computer language, in any form or by any means, without prior written permission of Cambium.

## **License Agreements**

The software described in this document is the property of Cambium and its licensors. It is furnished by express license agreement only and may be used only in accordance with the terms of such an agreement.

## **High Risk Materials**

Cambium and its supplier(s) specifically disclaim any express or implied warranty of fitness for any high-risk activities or uses of its products including, but not limited to, the operation of nuclear facilities, aircraft navigation or aircraft communication systems, air traffic control, life support, or weapons systems (“High Risk Use”).

This product is not restricted in the EU. Any High Risk is unauthorized, is made at your own risk and you shall be responsible for any and all losses, damage or claims arising out of any High-Risk Use.

© 2020 Cambium Networks Limited. All rights reserved

# Contents

---

<b>Contents</b> .....	<b>3</b>
<b>About This User Guide</b> .....	<b>8</b>
Contacting Cambium Networks .....	9
Purpose .....	9
Cross references .....	9
Feedback .....	9
Declaration of Conformity .....	10
Part 15 FCC Rules .....	10
Class B Digital Device or Peripheral .....	10
GNU GPL Information .....	10
Conventions, warnings, Attention, and notes .....	10
Conventions .....	10
Warnings .....	11
Attention .....	11
Notes .....	11
<b>Chapter 1: Product Description</b> .....	<b>12</b>
cnPilot Home Router Specifications .....	13
LED Indicators and Interfaces(r195P) .....	13
LED Indicators and Interfaces (r190V/r190W/r200/r200P/r195W) .....	15
LED Indicators and Interfaces (r190V/r190W/r200/r200P) .....	16
LED indicators and interfaces (r201/r201P/r201W) .....	18
Hardware installation .....	19
Procedure 1: Configuring the Router .....	19
<b>Chapter 2: Basic Settings</b> .....	<b>21</b>
Web Management Interface .....	21
EZ UI .....	21
Logging in from the LAN port .....	25
Logging in from the WAN port .....	26

Parental Control .....	27
Accessing and Configuring cnPilot Home Router via cnMaestro .....	28
Managing device via cnMaestro .....	28
Performing Speed Test .....	29
Configuring via Voice Commands .....	29
Making a Call .....	34
Direct IP calls .....	34
Call Hold .....	34
Blind Transfer .....	34
Attended Transfer .....	35
Conference .....	35
<b>Chapter 3: Advanced Configuration .....</b>	<b>36</b>
Two-Level Management .....	36
Setting the Time Zone .....	37
Status .....	38
Configuring an Internet Connection .....	42
Custom Factory Default Configuration .....	44
Configuring as Range Extender / Wi Fi Repeater .....	48
Repeater configuration .....	48
Base AP configuration for repeater mode .....	48
Repeater AP configuration .....	49
Network .....	54
WAN .....	54
IPv6 address configuration .....	70
LAN .....	75
Wireless .....	85
Basic .....	85
Wireless Security .....	88
WMM .....	91
WDS .....	91

WPS .....	92
Station Info .....	94
Advanced .....	95
Parental Control .....	96
How to Configure .....	97
Manual Configuration .....	100
SIP .....	100
SIP Settings .....	101
Dial Rule .....	103
Adding one Dial Plan .....	104
Dial Plan Syntactic .....	104
Blacklist .....	105
Call Log .....	107
VoIP QoS .....	109
FXS1 .....	109
SIP Account .....	109
Audio Configuration .....	110
Supplementary Service Subscription .....	112
Advanced .....	113
Preferences .....	115
Regional .....	116
Features and Call Forward .....	118
Miscellaneous .....	119
FXS2 .....	120
Security .....	121
Filtering Setting .....	121
Content Filtering .....	122
Application .....	123
UPnP .....	123
IGMP .....	123

Storage .....	123
Disk Management .....	123
FTP Setting .....	125
Smb Setting .....	126
Administration .....	126
Management .....	127
Firmware Upgrade .....	133
Provision .....	133
SNMP .....	136
TR-069 .....	136
Diagnosis .....	154
Operating Mode .....	157
System Log .....	157
Logout .....	157
Reboot .....	158
<b>Chapter 4: Troubleshooting .....</b>	<b>159</b>
Configuring PC to get IP Address automatically .....	159
Cannot connect to the Web GUI .....	159
Forgotten Password .....	159
cnMaestro On-boarding troubleshooting .....	159
<b>Appendix: Third Party Software .....</b>	<b>162</b>
Appendix: Part Numbers .....	162
Appendix: Part Numbers .....	162
Part Numbers for cnPilot r195P Home Router .....	163
Part Numbers for cnPilot r195W Home Router .....	163
Part Numbers for cnPilot r200, r200P Home Routers .....	164
Part Numbers for cnPilot R201, R201P Home Routers .....	164
Part Numbers for r201W Home Router .....	165
Part Numbers for cnPilot r190W Home Router .....	165
Part Numbers for cnPilot r190V Home Router .....	165

Glossary .....166

# About This User Guide

---

Thank you for choosing Cambium cnPilot Home and Small Business Wi-Fi Router with ATA (optional) and PoE (optional).

This manual provides basic information about how to install and deploy the cnPilot Home Routers.

For remote configuration and deployment, an Internet connection is required.

The cnPilot Home Router is a managed device (that yet can act as a stand-alone router if desired). In addition to Wi-Fi, this product provides high quality voice calls (VoIP models only) as well as the optional ability to power Cambium's ePMP series subscriber module or the PMP450 series subscriber module by supporting Cambium's (Canopy) PoE. For voice calls, the product is fully compatible with the SIP industry standard and can interoperate with many other SIP devices and softwares.





This guide contains the following chapters:

- Chapter 1: Product Description
- Chapter 2: Basic Settings
- Chapter 3: Advanced Configuration
- Chapter 4: Troubleshooting Guide

## Contacting Cambium Networks

Product Details	<a href="https://www.cambiumnetworks.com/products/wifi/">https://www.cambiumnetworks.com/products/wifi/</a>
Quick Start Guide	<a href="https://www.cambiumnetworks.com/products/wifi/">https://www.cambiumnetworks.com/products/wifi/</a>
User Guide	<a href="https://support.cambiumnetworks.com/files/r-series/">https://support.cambiumnetworks.com/files/r-series/</a>
Release Notes	<a href="https://support.cambiumnetworks.com/files/r-series/">https://support.cambiumnetworks.com/files/r-series/</a>
Software Resources	<a href="https://support.cambiumnetworks.com/files/r-series/">https://support.cambiumnetworks.com/files/r-series/</a>
Knowledge Base (KB) Articles	<a href="https://help.cambiumnetworks.com/hc/en-us/sections/206524647-cnPilot-R-series-R201-R201P-">https://help.cambiumnetworks.com/hc/en-us/sections/206524647-cnPilot-R-series-R201-R201P-</a>
Community	<a href="http://community.cambiumnetworks.com/t5/cnPilot-R-Series-Home-Small/bd-p/cnPilot">http://community.cambiumnetworks.com/t5/cnPilot-R-Series-Home-Small/bd-p/cnPilot</a>
Support	<a href="https://www.cambiumnetworks.com/support/">https://www.cambiumnetworks.com/support/</a>
Warranty	<a href="https://www.cambiumnetworks.com/support/warranty/">https://www.cambiumnetworks.com/support/warranty/</a>
Repair Queries	<a href="https://support.cambiumnetworks.com">https://support.cambiumnetworks.com</a>
Feedback	For feedback, e-mail to <a href="mailto:support@cambiumnetworks.com">support@cambiumnetworks.com/</a>

## Purpose

Cambium disclaims all liability whatsoever, implied or express, for any risk of damage, loss or reduction in system performance arising directly or indirectly out of the failure of the customer, or anyone acting on the customer's behalf, to abide by the instructions, system parameters, or recommendations made in this document.

## Cross references

References to external publications are shown in italics. Other cross references, emphasized in blue text in electronic versions, are active links to the references.

This document is divided into numbered chapters that are divided into sections. Sections are not numbered but are individually named at the top of each page and are listed in the table of contents.

## Feedback

We appreciate feedback from the users of our documents. This includes feedback on the structure, content, accuracy, or completeness of our documents. Send feedback to: [support@cambiumnetworks.com](mailto:support@cambiumnetworks.com).

# Declaration of Conformity

## Part 15 FCC Rules

This device complies with Part 15 of the FCC Rules. Operation is subject to the following two conditions:

- This device may not cause harmful interference, and
- This device must accept any interference received, including interference that may cause undesired operation.

## Class B Digital Device or Peripheral

This equipment has been tested and found to comply with the limits for a Class B digital device, pursuant to Part 15 of the FCC Rules. These limits are designed to provide reasonable protection against harmful interference in a residential installation. This equipment can generate, use and radiate radio frequency energy. If not installed and used in accordance with the instruction manual, may cause harmful interference to radio communications. However, there is no guarantee that interference does not occur in an installation.



### Note

Changes or modifications not expressly approved by the party responsible for compliance could void the user's authority to operate the equipment.

If this equipment does cause harmful interference to radio or television reception, which can be determined by turning the equipment OFF and ON, the user is encouraged to try to correct the interferences by one or more of the following measures:

- Reorient or relocate the receiving antenna.
- Increase the separation between the equipment and receiver.
- Connect the equipment into an outlet on a circuit different from that to which the receiver is connected.
- Consult the dealer or an experienced radio/TV technician for help.

## GNU GPL Information

cnPilot Home Router firmware contains third-party software under the GNU General Public License (GPL). Refer the GPL for exact terms and conditions of the license. Important regulatory information.

## Conventions, warnings, Attention, and notes

The following describes how conventions, warnings, attention, and notes are used in this document and in all documents of the Cambium Networks document set.

### Conventions

The following convention is used throughout this User Guide:

cnPilot Home Router: Cambium cnPilot Home and Small Business Wireless Router family (cnPilot r190V/r190W/r195W/r200/r200P/r201/r201P/r201W Home Router models)

## Warnings

Warnings precede instructions that contain potentially hazardous situations. Warnings are used to alert the reader to possible hazards that could cause loss of life or physical injury. A warning has the following format:



### Warning

Warning text and consequence for not following the instructions in the warning.

## Attention

Attention precedes instructions and are used when there is a possibility of damage to systems, software, or individual items of equipment within a system. However, this damage presents no danger to personnel. Attention has the following format:



### Attention

Attention text and consequence for not following the instructions.

## Notes

A note means that there is a possibility of an undesirable situation or provides additional information to help the reader understand a topic or concept. A note has the following format:



### Note

Note text.

# Chapter 1: Product Description

---

This chapter describes the following sections:

- [cnPilot Home Router Specifications](#)
- [LED Indicators and Interfaces \(r190V/r190W/r200/r200P/r195W\)](#)
- [LED Indicators and Interfaces \(r190V/r190W/r200/r200P\)](#)
- [LED Indicators and Interfaces \(r201/r201P/r201W\)](#)
- [Hardware Installation](#)



## Note

This product meets the UL/cUL 62368 /IEC 62368 edition 2 specification.

## cnPilot Home Router Specifications

Features	r190V	r190W	r200P	r200	r201	r201P	r201W	r195W	r195P
WAN	1xFE				1xGE				
LAN	3xFE	4xFE			4xGE				
Wi-Fi 2.4GHz	2X2 802.11 b/g/n								
Wi-Fi 5GHz	X				2X2 5GHz 802.11ac (867 Mbps)				
USB	X	X	1X USB 2.0				X	1X USB 2.0	
VoIP	2xFXS <sup>1</sup>	X	2xFXS <sup>1</sup>				X	X	2xFXS <sup>1</sup>
Cambium PoE Out (30V)	X		Yes <sup>2</sup>	X	X	Yes <sup>3</sup>	X	X	Yes
Power Adapter	12V/1A	5V/1A	12V/3A	12V/2A	12V/2A	12V/3A	12V/2A	12V/1A	12V/3A
cnMaestro Managed	✓								
RAM	128MB		64MB		256MB			64 MB	128MB
Flash	16MB								32MB

## LED Indicators and Interfaces(r195P)

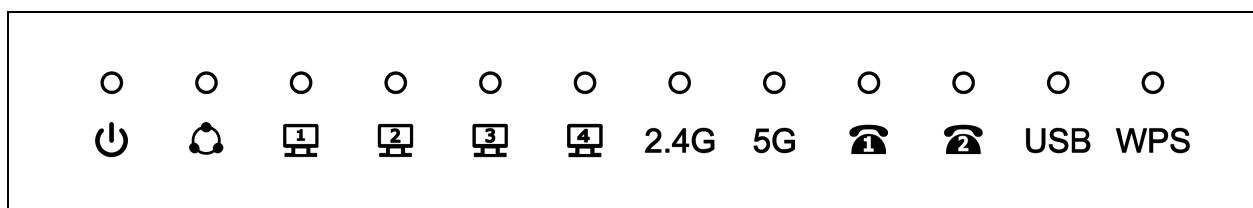

Figure 1: cnPilot r195P Home Router LED indicators

<sup>1</sup>A maximum of four devices may be connected to each FXS port.

<sup>2</sup>One PMP or ePMP device at a time may be powered by the Power-over-Ethernet (PoE) port.

<sup>3</sup>One PMP or ePMP device at a time may be powered by the Power-over-Ethernet (PoE) port.

LED	Status	Explanation
WPS	Blinking on 5 GHz (Blue)	Wireless client is connected, data transmission in progress
	On (Blue)	2.4G or 5G WPS is enabled.
	Off	Power is Off or WPS disabled.
USB	Blinking on 5 GHz (Blue)	Data transmission in progress
	On (Blue)	USB disk connected successfully
	Off	NA
FXS	Off	Unregistered
	On	Registered
	Blinking on 1 Hz	In use
2.4G	Blinking (Green)	2.4G is connected, and there is data transmitted
	On (Green)	Wireless access point is ready
	Off	2.4G WiFi off or system is powered off
5G	Blinking (Green)	5G is connected, and there is data transmitted
	On (Green)	Wireless access point is ready
	Off	5G WiFi off or system is powered off
WAN	Blinking (Green)	There is data being transmitted
	On (Green)	Network is connected (physical connection established), no data transmission
	Off	System is powered off or the network port is not connected to the network device
LAN (1-4)	Blinking (Green)	There is data being transmitted
	On (Green)	Network is connected (physical connection established), no data transmission
	Off	System is powered off or the network port is not connected to the network device
POWER	On (Green)	System is powered ON
	Off	System is powered OFF

## Rear panel of cnPilot r195P Home Router

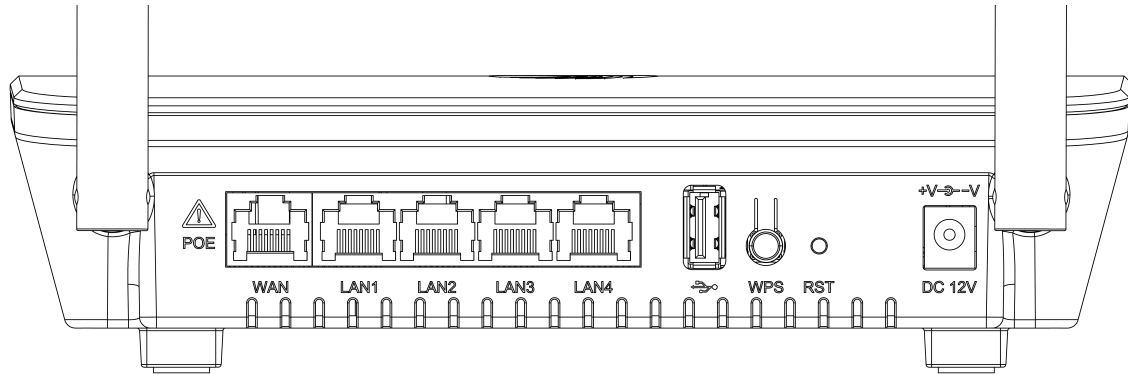

Table 1: cnPilot r195P Home Router interfaces

Interface	Description
POWER	Connector for a power adapter
Phone1/2	ATA Analog phone connector
USB	USB interface
WAN	Connector for accessing the Internet
LAN (1/2/3/4)	Connectors for local networked devices

## LED Indicators and Interfaces (r190V/r190W/r200/r200P/r195W)

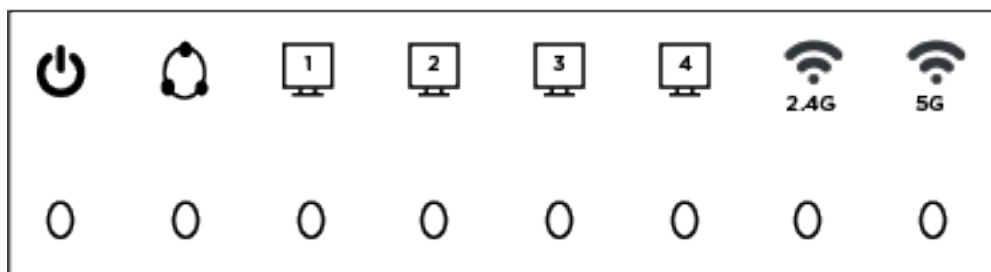

Figure 2: cnPilot LED indicators

LED	Status	Explanation
2.4G	Blinking (Green)	2.4G is connected, and there is data transmitted
	On (Green)	Wireless access point is ready
	Off	2.4G WiFi off or system is powered off

LED	Status	Explanation
5G	Blinking (Green)	5G is connected, and there is data transmitted
	On (Green)	Wireless access point is ready
	Off	5G WiFi off or system is powered off
WAN	Blinking (Green)	There is data being transmitted
	On (Green)	Network is connected (physical connection established), no data transmission
	Off	System is powered off or the network port is not connected to the network device
LAN (1-4)	Blinking (Green)	There is data being transmitted
	On (Green)	Network is connected (physical connection established), no data transmission
	Off	System is powered off or the network port is not connected to the network device
POWER	On (Green)	System is powered ON
	Off	System is powered OFF

## LED Indicators and Interfaces (r190V/r190W/r200/r200P)

### Front Panel of cnPilot r200/r200P Home Router

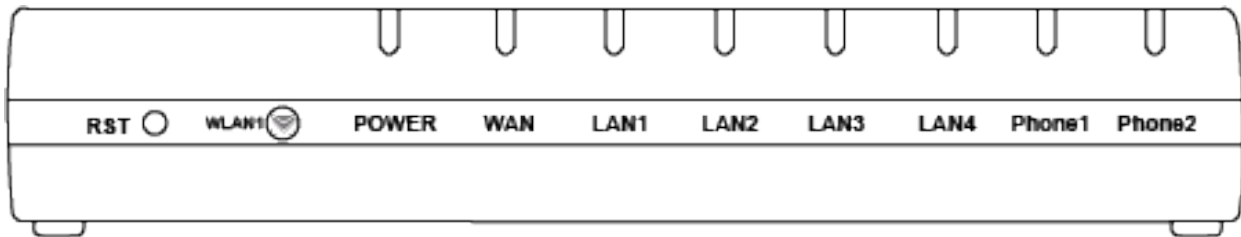

Table 2 :cnPilot r200/r200P LED indicators

LED	Status	Explanation
Phone1/2	Blinking (Green)	Not registered
	On (Green)	Registered



LED	Status	Explanation
LAN 1/2/3/4	On (Green)	Port is connected at 100 Mbps
	Off	The port is disconnected
	Blinking (Green)	Transmitting data
WAN	On (Green)	Port is connected with 100 Mbps
	Off	The port is disconnected
	Blinking (Green)	Blinks while transmitting data
POWER	On (Green)	The router is powered on and running normally
	Off	The router is powered off
WLAN	On (Green)	Wireless access point is ready
	Blinking (Green)	Blinks while wireless traffic goes through

### Front Panel of cnPilot r190V/r190W Home Router

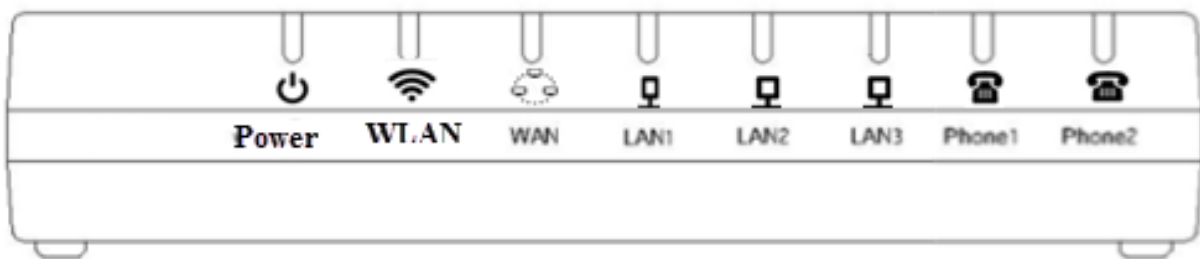

Table 3 :cnPilot r190V/r190W LED indicators

LED	Status	Explanation
Power	On	Power is ON/Device is ready
	Blinking on 10Hz	Firmware upgrade
	Blinking on 1Hz	No IP Address for both PPPoE or DHCP mode
WAN/LAN	On	Link is Up
	Blinking	Blinks while transmitting data
	Off	Disconnected
FXS	Off	Unregistered
	On	Registered
	Blinking on 1 Hz	In use

## Rear Panel of cnPilot r190V/r190W/r200/r200P Home Router

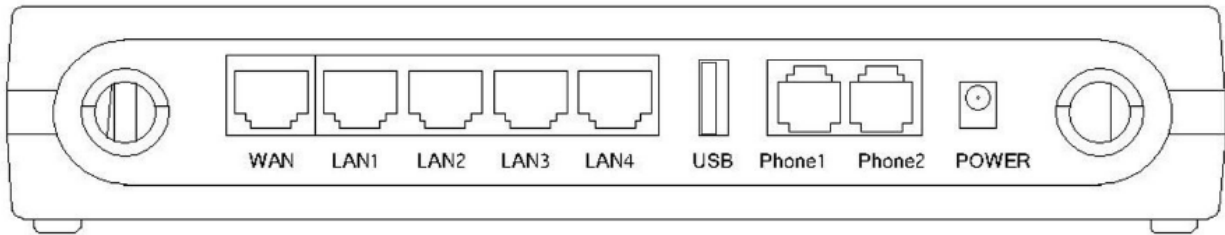
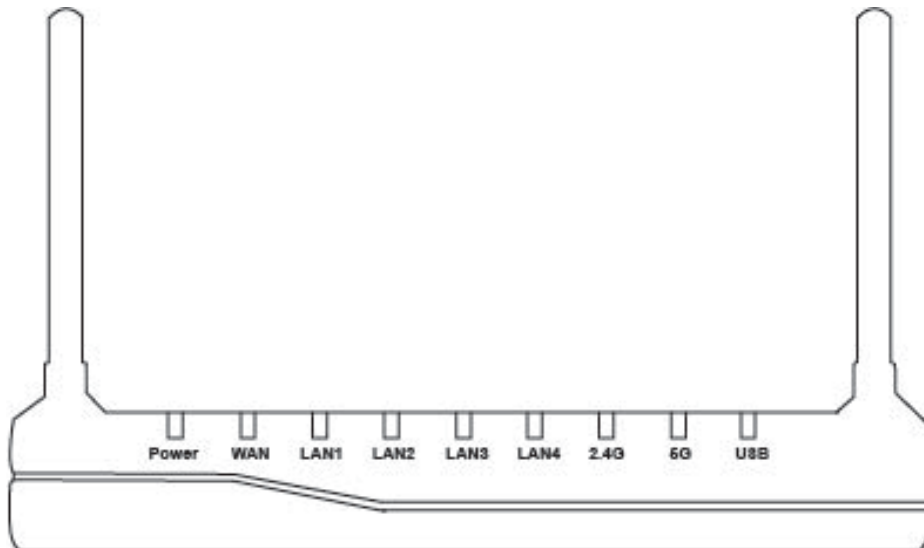

Table 4 : cnPilot r190V/r190W/r200/r200P interfaces Home Routers

Interface	Description
POWER	Connector for a power adapter
Phone1/2	ATA Analog phone connector
USB	USB interface
WAN	Connector for accessing the Internet
LAN (1/2/3/4)	Connectors for local networked devices

## LED indicators and interfaces (r201/r201P/r201W)

Table 5 :cnPilot r201/r201P/r201W LED indicators



LED	Status	Explanation
USB	On (Green)	Connected
	Off	Disconnected

LED	Status	Explanation
2.4G/5G	Blinking (Green)	The port is passing data
	On (Green)	The port is connected
WAN	Off	The port is disconnected
	Blinking (Green)	The data is transmitting
	On (Green)	The port is connected at 100/1000 Mbps
LAN 1/2/3/4	Off	The port is disconnected
	Blinking (Green)	The port is transmitting data
POWER	ON (Green)	Router is powered on and running normally
	Off	The router is powered off

Table 6 :cnPilot r201/r201P/r201W interfaces

Interface	Description
ON/OFF	Power Switch
POWER	Connector for a power adapter
USB	USB interface
LAN (1/2/3/4)	Connectors for local networked devices
WAN	Connector for accessing the Internet

## Hardware installation

Before configuring your router, please see the procedure below for instructions on connecting the cnPilot Home Router in your network.



### Note

In order to ensure that the equipment is operated in accordance with applicable regulations, it is the responsibility of the operator of the device to ensure that the most recent Firmware updates are applied. Download the latest Firmware and install it in the device before deploying the cnPilot device. Instructions for installing Firmware are provided in the latest Firmware updates and are available on our support site: <https://support.cambiumnetworks.com>.

## Procedure 1: Configuring the Router

1. Connect analog phone to ATA Port with an RJ11 cable.
2. Connect the WAN port to the Internet via your network's modem/switch/router/ADSL equipment using an Ethernet cable.
3. Connect one end of the power cord to the power port of the device. Connect the other end to the wall outlet.

4. Push the ON/OFF button to power on the router (If available).
5. Check the Power, WAN, and LAN LEDs to confirm network connectivity.

**Warning**

Do not attempt to use unsupported power adapters and do not remove power during configuring or updating the cnPilot Home Router device. Using other power adapters may damage the cnPilot Home Router and will void the manufacturer warranty.

**Warning**

Changes or modifications not expressly approved by the party responsible for compliance can void the user's authority to operate the equipment.

This equipment has been tested and found to comply with the limits for a Class B digital device, pursuant to Part 15 of the FCC Rules. These limits are designed to provide reasonable protection against harmful interference in a residential installation. This equipment generates, uses and can radiate radio frequency energy and, if not installed and used in accordance with the instructions, may cause harmful interference to radio communications. However, there is no guarantee that interference will not occur in a particular installation.

If this equipment does cause harmful interference to radio or television reception, which can be determined by turning the equipment off and on, the user is encouraged to try to correct the interference by one or more measures.

# Chapter 2: Basic Settings

This chapter covers:

- Web Management Interface
- Accessing and Configuring cnPilot Home Router via cnMaestro
- Configuring via Voice Commands

## Web Management Interface

cnPilot Home Routers feature a web browser-based interface that may be used to configure and manage the device. See below for information.



**Note**  
By default, only https access is allowed. Any attempt to access the device UI over http will now be automatically redirected to https.

## EZ UI

cnPilot Home Routers provides an additional simplified management interface for home users. The home users can connect to any of the LAN port of the device and access the EZ UI by entering <https://mywifi.net> in the browser.

Home users needs to provide the default **Basic User** credentials as **useradmin/admin**.



**Note**  
Please check with your ISP in case the basic user credentials have been changed for improved security.

Figure 1: EZ UI

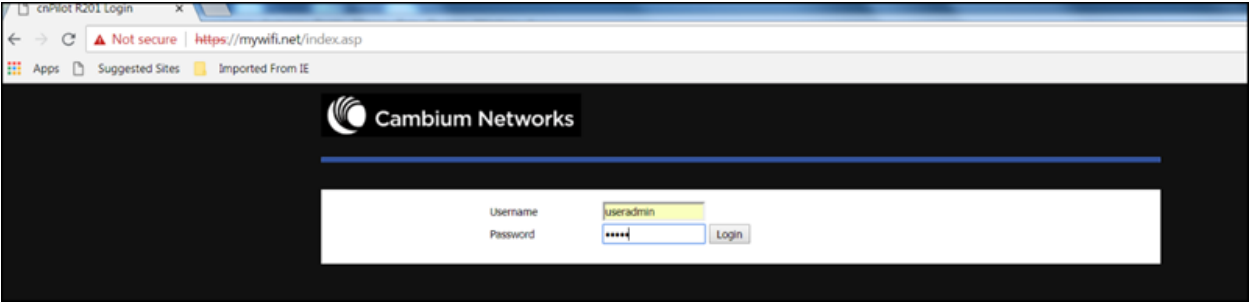

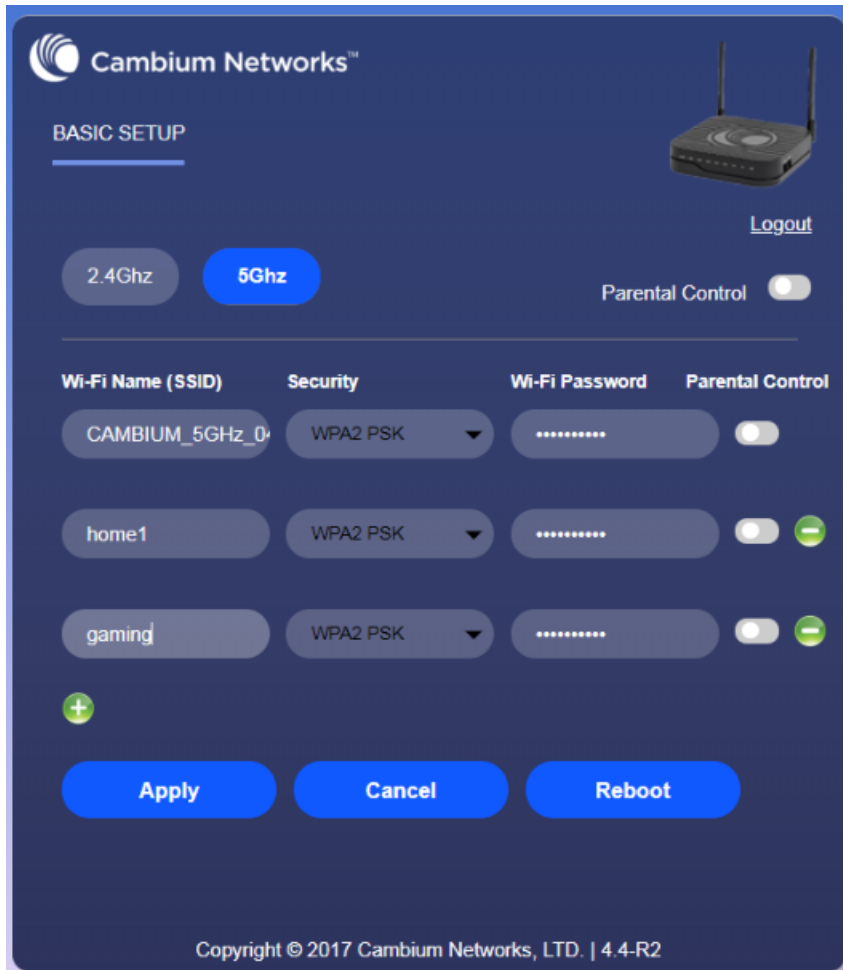

The ISP allows the home user to access the EZ UI through a wireless client connected to the cnPilot Home Router. Using the EZ UI, the user can easily change the basic device configurations such as Wi-Fi names, Wi-Fi passwords and parental control.

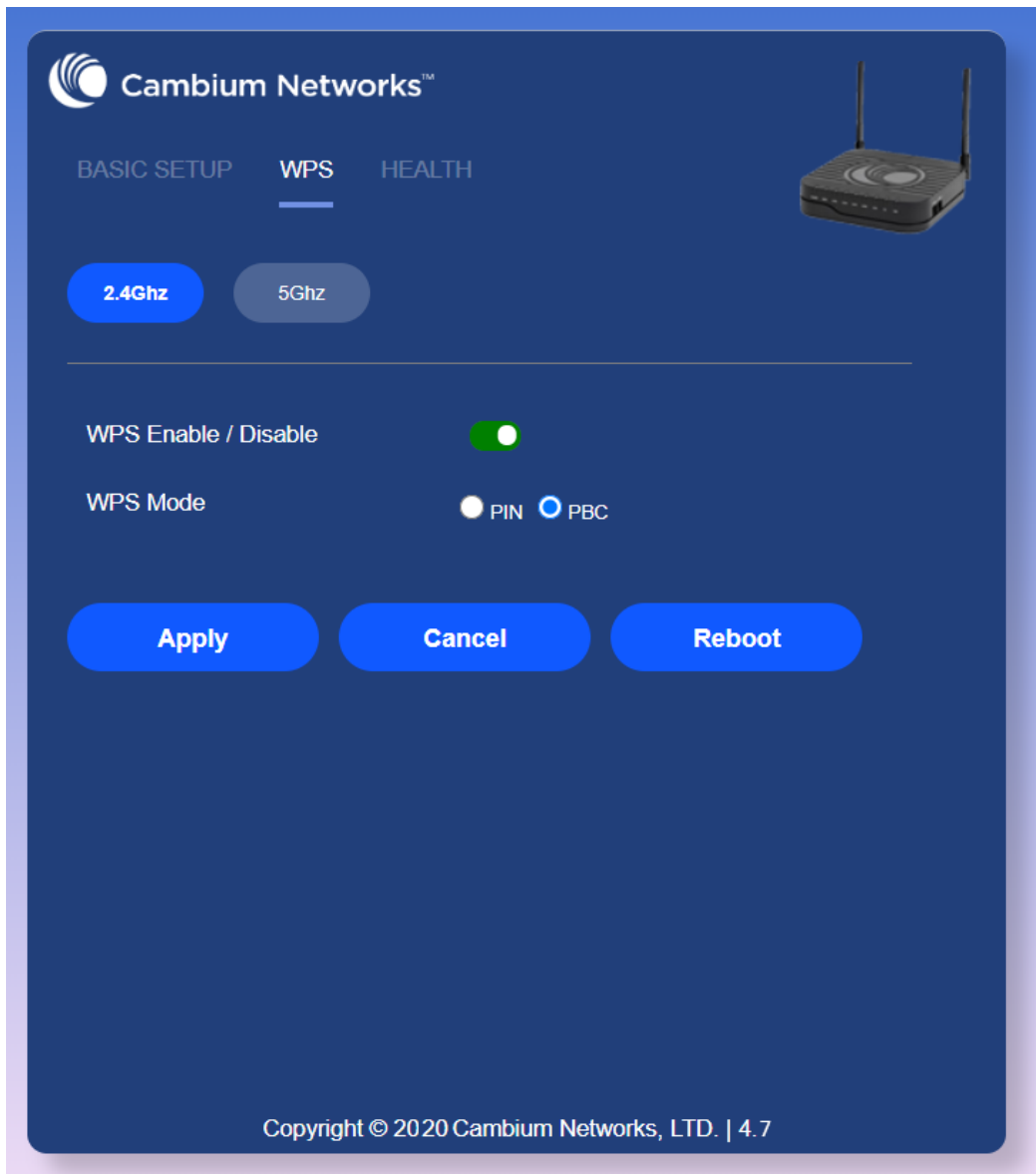

The EZ-UI now has a new WPS tab, which provides easy procedure to make network connection between wireless station and wireless access point with the encryption of WPA and WPA2.

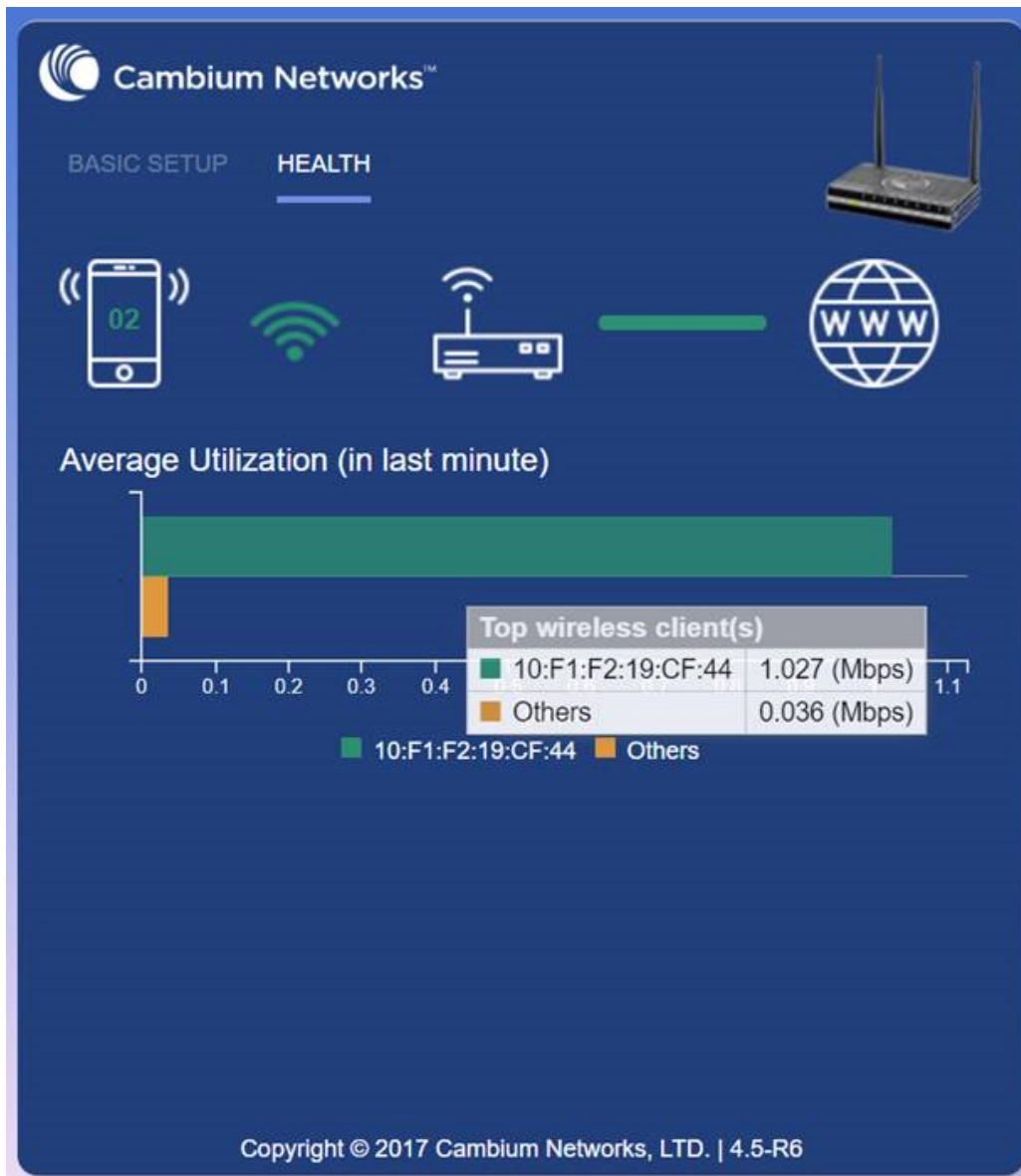

The EZ-UI now has a new HEALTH tab, which shows the overall health of the home network. It helps isolate problems if any and provide basic insight into the bandwidth utilization.



**Note**

Option to turn Off EZ UI - an option is provided to disable EZ-UI and revert to the conventional Basic User mode UI.



**Daylight Saving Time**

Daylight Saving Time

---

**System Log Setting**

**Syslog Setting**

Syslog Enable

Syslog Level

Remote Syslog Enable

Remote Syslog Server

---

**Factory Defaults Setting**

**Factory Defaults Setting**

Factory Defaults Lock

---

**EZ UI setting**

**EZ UI setting**

EZ UI setting

---

**Factory Defaults**

Reset to Factory Defaults

## Logging in from the LAN port

Ensure that your PC is connected to the router's LAN port correctly.



### Note

You may either set up your PC to get an IP dynamically from the router or set up the IP address of the PC to be the same subnet as the default IP address of router is 192.168.11.1. For more information, refer Configuring PC to get IP Address automatically.



### Note

Management access from a wireless client is enabled by default. Refer Enabling Management access for wireless clients on "How to enable management access for wireless clients".

Open a web browser on your PC and type **https://192.168.11.1/**. The following window appears to enter Username and Password.

Figure 2 : Login Prompt - LAN Port

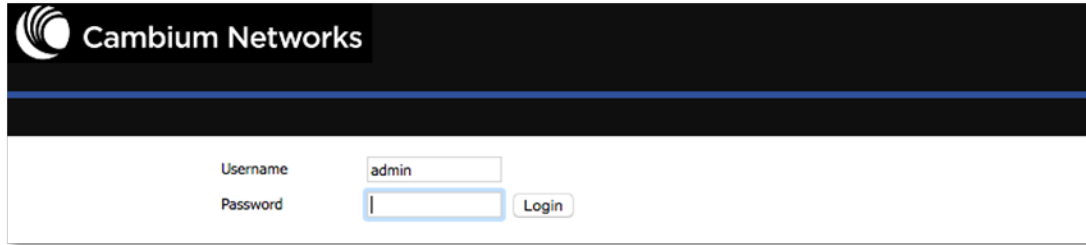

For administrator mode operation, type **admin/admin** for Username/Password and click **Login** to begin configuration. For user mode operation, please type **user/user** for Username/Password and click **Login** to begin configuration.



#### Note

If you are unable to access the web configuration, please see Configuring PC to get IP Address automatically for more information.

The web management interface automatically logs out the user after 5 minutes of inactivity.

## Logging in from the WAN port



#### Note

By default, the web access from WAN interface is disabled from 4.3.3 release onwards for security reasons for cnPilot r190/r200/r201. Users can enable this from GUI (via LAN client).

For r195W WAN access is enabled by default, however login is not allowed if default admin credentials are configured on the device. cnPilot r195W Home Router UI can be accessed via WAN by setting non default admin credentials.

Ensure that your PC is connected to the router's WAN port correctly.

Obtain the IP addresses of WAN port using Voice prompt or by logging into the device web management interface via a LAN port and navigating to **Status** page.

Open a web browser on your PC and type **https://<IP address of WAN port>**. The following login page will be opened to enter username and password.

Figure 3: Login Prompt - WAN Port

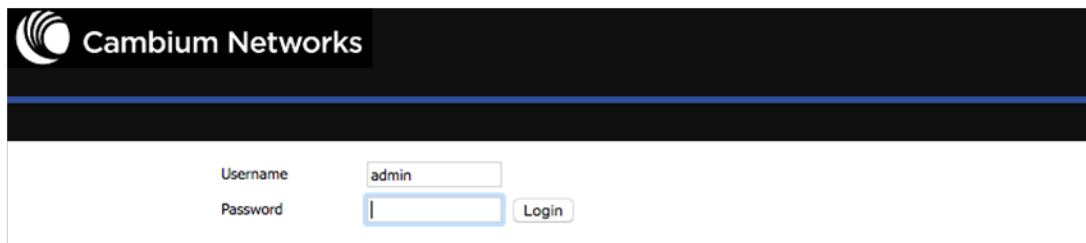

For administrator mode operation, type **admin/admin** for Username/Password and click **Login** to begin configuration. For user mode operation, type **user/user** for Username/Password and click Login to begin configuration.



### Note

If you fail to access to the web configuration, see Chapter 4: Troubleshooting Guide for more information.

The web management interface automatically logs out the user after 5 minutes of inactivity.

## Parental Control

cnPilot Home Routers provide parental control feature for home users. Parental control allows home users to restrict access to unlawful/adult content over their WiFi network. This feature is based on external DNS filtering (like OpenDNS).

Parental Control feature enable/disable is only available via EZ UI. To enable parental control feature, tap on the **Parental Control** button.

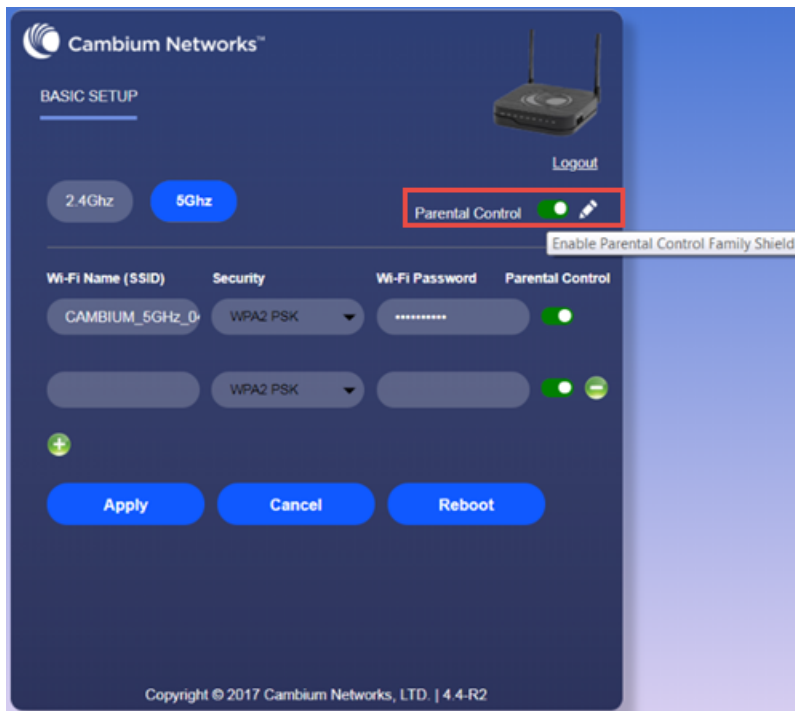

To configure cnPilot Home Router with the DNS server IP(s) provided by the Parental control service provider:

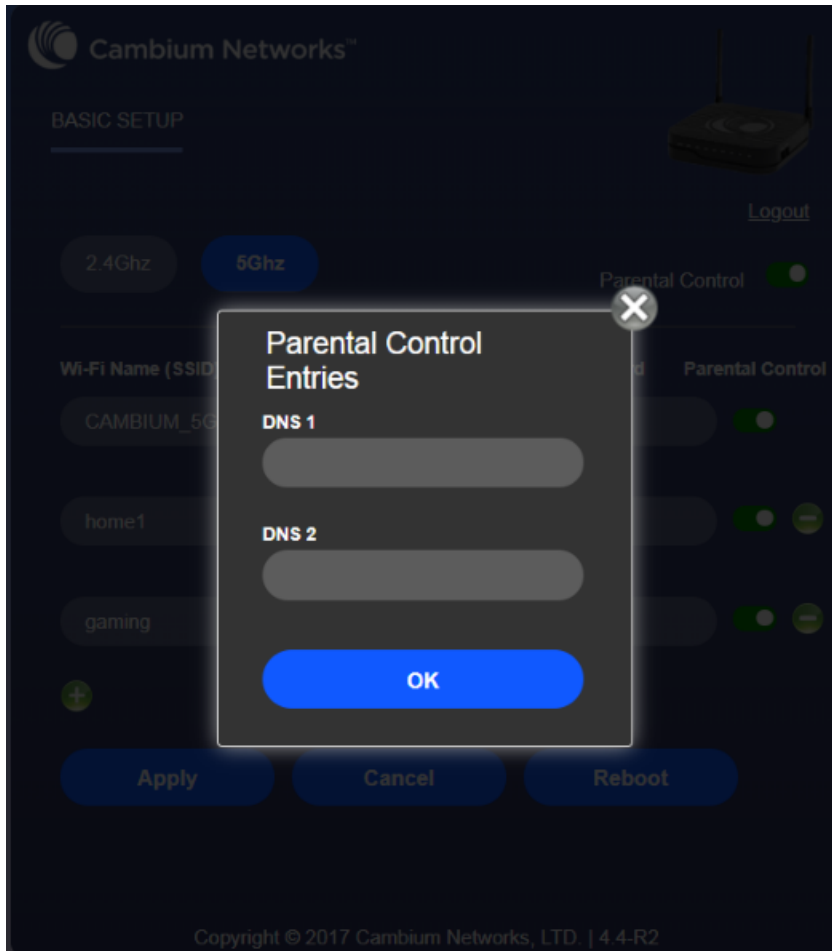

Parental control feature can be applied only to a specific WiFiName/SSID while the other SSIDs can be free from any such restrictions. Once the device is setup for Parental control service, any DNS request from its clients will be forwarded to the external DNS servers configured for filtering/restricting the content.

When Parental control is enabled, it is applied to all the LAN clients and it cannot be disabled for specific LAN ports.

## Accessing and Configuring cnPilot Home Router via cnMaestro

cnMaestro, Cambium's next generation network management system is the recommended method for managing Cambium's cnPilot Home Routers. As Cambium develops new features, you may find the latest information on operating these features at the Cambium Community Forum.

Register at Cambium's support forum (<http://community.cambiumnetworks.com/>) for instructions, discussions, and helpful tips on managing cnPilot Home Routers.

## Managing device via cnMaestro

cnMaestro is a suite of cloud-based tools for network management: inventory management, onboarding devices, daily operations and maintenance. cnMaestro offers full visibility across the entirety of a network.

## Preparing the device

The prerequisites at device side are:

1	Power on the <b>cnPilot Home Router</b> and configure the IP Address using either the DHCP or Static mode.
2	Check for the Internet connectivity. This is required, as the device needs to communicate with the cnMaestro Server hosted in the AWS.
3	Allow the IP Addresses of the devices in the Firewall Server using an ACL. Also, enable the protocols like HTTP/HTTPS and SSL.  This is required as the device communicates with the cnMaestro Server using web sockets and for security reasons SSL certificates are exchanged between the device and the cnMaestro Serve
4	Devices with default configuration can configure to <a href="https://cloud.cambiumnetworks.com">https://cloud.cambiumnetworks.com</a> . Users may choose to configure alternate On-Premises IP address/URL.



### Note

In 4.6 release, the following options are introduced under **cnMaestro Configuration** page:

- **IPv6 Preferred** - if a router is deployed in a mixed environment (IPv4 and IPv6), this option allows user to onboard their device using IPv6
- **Use Management Interface** - in a multi WAN configuration, this option allows the user to choose the management WAN as the channel for cnMaestro communication.

For more information on Onboarding cnPilot Wi-Fi routers, refer [cnMaestro User Guide](#).

## Performing Speed Test

The cnPilot Home Routers support speed test service and it can be triggered from cnMaestro On-Premises server.



### Note

The port that is used for Wi-Fi performance in cnMaestro On-Premises is 18301 (UDP and TCP).

The cnMaestro On-Premises supports the speed test feature from 1.5.1 release onwards. For more information, refer *Wi-Fi performance* in [On-Premises User Guide](#).

## Configuring via Voice Commands

cnPilot Home Routers may be configured by navigating the unit's voice menu. This option is only available on models with VoIP support. By using your phone and dialing a sequence of commands, the device may be configured for operation. Each device configuration section may be accessed by entering a certain operation code, as shown in following table.

Table 7 :Voice Menu Setting Options

Operation code	Menu Navigation	
<p>1</p> <p>Network configuration</p>	<p>Pick up phone and press “****” to start IVR</p> <p>Choose “1”.</p> <p>Prompts “Please enter password”, user needs to input password and press “#” key, if user wants to configure Network.</p> <p>The different options are described below:</p> <p>The unit reports “Operation Successful” if the changes are successful. The cnPilot Home Router returns to the prompt “please enter your option ...”</p> <p>To quit, enter “*”</p>	
<p>1</p> <p>Network configuration</p>	<p>1. WAN Port Connection Type</p>	<p>Pick up phone and press “****” to start IVR</p> <p>Choose “1”, and cnPilot Home Router reports the current WAN port connection type.</p> <p>Prompt “Please enter password”, user needs to input password and press “#” key, if user wants to configuration WAN port connection type.</p> <p>The password in IVR is same as web management interface login, the user may use phone keypad to enter password directly.</p> <p>For example: WEB login password is “admin”, so the password in IVR is “admin”. The user may “23646” to access and then configure the WAN connection port. The unit reports “Operation Successful” if the password is correct.</p> <p>Prompt “Please enter password”, user needs to input password and press “#” key if user wants to configuration WAN port connection type.</p> <p>Choose the new WAN port connection type (1) DHCP or (2) Static.</p> <p>The unit reports “Operation Successful” if the changes are successful. The cnPilot Home Router returns to the prompt “please enter your option ...”</p> <p>To quit, enter “*”</p>
	<p>2. WAN Port IP Address</p>	<p>Pick up phone and press “****” to start IVR</p> <p>Choose “2”, and cnPilot Home Router</p>

Operation code	Menu Navigation	
		<p>reports current WAN Port IP Address</p> <p>Input the new WAN port IP address and press “#” key:</p> <p>Use “*” to replace “.”, for example user can input 192*168*20*168 to set the new IP address 192.168.20.168</p> <p>Press # key to indicate that you have finished</p> <p>Report “operation successful” if user operation is fine.</p> <p>To quit, enter “***”.</p>
<p>1</p> <p>Network configuration</p>	<p>3. WAN Port Subnet Mask</p>	<p>Pick up phone and press “****” to start IVR</p> <p>Choose “3”, and cnPilot Home Router reports current WAN port subnet mask.</p> <p>Input a new WAN port subnet mask and press # key:</p> <p>Use “*” to replace “.”, user can input 255*255*255*0 to set the new WAN port subnet mask 255.255.255.0.</p> <p>Press “#” key to indicate that you have finished.</p> <p>Report “operation successful” if user operation is fine.</p> <p>To quit, enter “***”.</p>
	<p>4. Gateway</p>	<p>Pick up phone and press “****” to start IVR</p> <p>Choose “4”, and cnPilot Home Router reports current gateway</p> <p>Input the new gateway and press “#” key:</p> <p>Use “*” to replace “.”, user can input 192*168*20*1 to set the new gateway 192.168.20.1.</p> <p>Press “#” key to indicate that you have finished.</p> <p>Report “operation successful” if user operation is fine.</p> <p>To quit, press “***”.</p>
	<p>5. DNS</p>	<p>Pick up phone and press “****” to start IVR</p>

Operation code	Menu Navigation	
		<p>Choose "5", and cnPilot Home Router reports current DNS</p> <p>Input the new DNS and press # key:</p> <p>Use "*" to replace ".", user can input 192*168*20*1 to set the new gateway 192.168.20.1.</p> <p>Press "#" key to indicate that you have finished.</p> <p>Report "operation successful" if user operation is fine.</p> <p>If you want to quit, press "***".</p>
<p>2</p> <p>Phone Port Configuration</p>	<p>Pick up phone and press "****" to start IVR</p> <p>Choose "2", and cnPilot Home Router reports the current Phone port connection type.</p> <p>Prompt "Please enter password", user needs to input password and press "#" key, if user wants to configuration Phone port connection type.</p> <p>Prompt "Please enter password", user needs to input password and press "#" key if user wants to configuration WAN port connection type.</p> <p>To quit, enter "**"</p>	
<p>3</p> <p>Factory Reset</p>	<p>Pick up phone and press "****" to start IVR</p> <p>Choose "3", and cnPilot Home Router reports "Factory Reset"</p> <p>Prompt "Please enter password", the method of inputting password is the same as operation 1.</p> <p>If you want to quit, press "**".</p> <p>Prompt "operation successful" if password is right and then cnPilot Home Router will be in factory default configuration.</p> <p>Press "7" reboot to make changes effective.</p>	
<p>4</p> <p>Reboot</p>	<p>Pick up phone and press "****" to start IVR</p> <p>Choose "4", and cnPilot Home Router reports "Reboot".</p> <p>Prompt "Please enter password", the method of inputting password is same as operation 1.</p> <p>cnPilot Home Router reboots if password is right and operation is fine.</p>	
<p>5</p>	<p>Pick up phone and press "****" to start IVR.</p> <p>Choose "5", and cnPilot Home Router reports "WAN Port Login".</p> <p>Prompt "Please enter password", the method of inputting password is</p>	



Operation code	Menu Navigation
WAN Port Login	<p>same as operation 1.</p> <p>If user wants to quit, press “*”.</p> <p>Report “operation successful” if user operation is fine.</p>
6 WEB Access Port	<p>Pick up phone and press “****” to start IVR.</p> <p>Choose “6”, and cnPilot Home Router reports “WEB Access Port”.</p> <p>Prompt “Please enter password”, the method of inputting password is same as operation 1.</p> <p>Report “operation successful” if user operation is ok.</p> <p>Report the current WEB Access Port.</p> <p>Set the new WEB access port and press “#” key.</p> <p>Report “operation successful” if user operation is successful.</p>
7 Firmware Version	<p>Pick up phone and press “****” to start IVR.</p> <p>Choose “7” and cnPilot Home Router reports the current Firmware version.</p>



#### Note

While using Voice menu, press \* (star) to return to Main menu.

If any changes made in the IP assignment mode, the router must be rebooted for the settings to take effect.

While entering an IP address or subnet mask, use "\*" (star) to enter "." (Dot) and use "#" (hash) key to finish entering IP address or subnet mask.

For example, to enter the IP address 192.168.20.159 by keypad, press these keys: 192\*168\*20\*159, use the #(hash) key to indicate that you have finished entering the IP address.

Use the # (hash) key to indicate that you have finish entering the IP address or subnet mask.

While assigning an IP address in Static IP mode, setting the IP address, subnet mask and default gateway is required to complete the configuration. If in DHCP mode, please make sure that a DHCP server is available in your existing broadband connection to which WAN port of cnPilot Home Router is connected.

The default LAN port IP address of cnPilot Home Routers is 192.168.11.1 and this address should not be assigned to the WAN port IP address of cnPilot Home Router in the same network segment of LAN port.

The password can be entered using phone keypad, the mapping table between number and letters as follows:

To input: D, E, F, d, e, f -- press '3'

To input: G, H, I, g, h, i -- press '4'

To input: J, K, L, j, k, l -- press '5'  
To input: M, N, O, m, n, o -- press '6'  
To input: P, Q, R, S, p, q, r, s -- press '7'  
To input: T, U, V, t, u, v -- press '8'  
To input: W, X, Y, Z, w, x, y, z -- press '9'  
To input all other characters in the administrator password-----press 'O',  
E.g. password is 'admin-admin', press '236460263'

## Making a Call

### Calling phone or extension numbers

To make a phone or extension number call:

- Both ATA and the other VoIP device (i.e., another ATA or other SIP products) must have public IP addresses, or
- Both ATA and the other VoIP device (i.e., another ATA or other SIP products) are on the same LAN using private or public IP addresses, or
- Both ATA and the other VoIP device (i.e., another ATA or other SIP products) can be connected through a router using a public or private IP addresses.

To make a call, first pick up the analog phone or turn on the speakerphone on the analog phone, enter the extension or phone number directly, end with #.

### Direct IP calls

Direct IP calling allows two phones, that is, an ATA with an analog phone and another VoIP Device, to talk to each other without a SIP proxy. VoIP calls can be made between two phones if:

- Both ATA and the other VoIP device (i.e., another ATA or other SIP products) have public IP addresses, or
- Both ATA and the other VoIP device (i.e., another ATA or other SIP products) are on the same LAN using private or public IP addresses, or
- Both ATA and the other VoIP device (i.e., another ATA or other SIP products) can be connected through a router using public or private IP addresses.

To make a direct IP call, first pick up the analog phone or turn on the speakerphone on the analog phone, Input the IP address directly, with the end "#".

### Call Hold

While in conversation, pressing the "\*77" to put the remote end on hold, then you will hear the dial tone and the remote party will hear hold tone at the same time.

Pressing the "\*77" again to release the previously hold state and resume the bi-directional media.

### Blind Transfer

Assume that call party A and party B are in conversation. Party A wants to Blind Transfer B to C:

Party A dials “\*78” to get a dial tone, then dials party C’s number, and then press immediately key # (or wait for 4 seconds) to dial out.

A can hang up.

## Attended Transfer

Assume that call party A and B are in a conversation. A want to Attend Transfer B to C:

- Party A dials “\*77” to hold the party B, when hear the dial tone, A dials C’s number, then party A and party C are in conversation.
- Party A dials “\*78” to transfer to C, then B and C now in conversation.
- If the transfer is not completed successfully, then A and B are in conversation again.

## Conference

Assume that call party A and B are in a conversation. A want to add C to the conference:

- Party A dials “\*77” to hold the party B, when hear the dial tone, A dial C’s number, then party A and party C are in conversation.
- Party A dials “\*88” to add C, then A and B, for conference.

# Chapter 3: Advanced Configuration

---

This chapter guides users to execute advanced (full) configuration through admin mode operation.

This chapter covers:

- Two-Level Management
- Setting the Time Zone
- Status
- Configuring an Internet Connection
- Custom Factory Default Configuration
- Configuring as Range Extender / Wi Fi Repeater
- Wireless
- SIP
- FXS1
- FXS2
- Security
- Application
- Administration
- System Log
- Logout
- Reboot

## Two-Level Management

This section explains how to setup a password for an administrator or user and how to adjust basic and advanced settings.

cnPilot Home Router supports two-level management: administrator and user. For administrator mode operation, please type “admin/admin” on Username/Password and click Login button to begin configuration. For user mode operation, please type “user/user” on Username/Password and click Login button to begin configuration.



### Note

It is highly recommended to change the admin/user passwords to non-default values.

## Setting the Time Zone

**Time/Date Setting**

**NTP Settings**

NTP Enable Enable

Current Time 1970 - 01 - 01 . 08 : 01 :  
13

Sync with host

NTP Settings (GMT+08:00) China Coast, Hong Kong

Primary NTP Server

Secondary NTP Server

NTP synchronization(1 - 1440m)

**Daylight Saving Time**

Daylight Saving Time Disable

Table 8 :Setting time zone

Field Name	Description
NTP Enable	Enable NTP (Network Time Protocol) to automatically retrieve time and date settings for the device.
Current Time	When NTP Enable is set to “Disable”, manually configure the time and date via the Current Time parameter.
Sync with host	Press <input type="button" value="Sync with host"/> button to synchronize the host PC date, time and time zone.
Primary NTP Server	Primary and secondary NTP server address for clock synchronization. A valid NTP server must be reachable for full NTP functionality.
Secondary NTP Server	
NTP Synchronization (1-1440m)	The synchronization period with NTP (1-1440 minutes), default is 60.

# Status

**Status** | Network | Wireless | SIP | FXS1 | FXS2 | Security | Application | Storage

Basic | LAN Host | Syslog

---

**Product Information**

**Product Information**

Product Name	cnPilot R.200P
Internet(WAN) MAC Address	00:04:56:04:27:89
PC(LAN) MAC Address	00:04:56:04:27:88
Hardware Version	V1.3
Loader Version	V3.07(Aug 20 2015 17:38:07)
Firmware Version	4.3-R1(201601131522)
Device-Agent Version	2.13
Serial Number	400FRG088N4X

---

**SIP Account Status**

**SIP Account Status**

FXS 1 SIP Account Status	Disable
Primary Server	0.0.0.0
Backup Server	0.0.0.0
FXS 2 SIP Account Status	Disable
Primary Server	0.0.0.0
Backup Server	0.0.0.0

---

**FXS Port Status**

**FXS Port Status**

FXS 1 Hook State	On
FXS 1 Port Status	Idle
FXS 2 Hook State	On
FXS 2 Port Status	Idle

**FXS Port Status**

FXS Port Status

FXS 1 Hook State	On
FXS 1 Port Status	Idle
FXS 2 Hook State	On
FXS 2 Port Status	Idle

**Network Status**

Active WAN Interface

Connection Type	DHCP
IP Address	192.168.210.230 <input type="button" value="Renew"/>
Link-Local IPv6 Address	
Subnet Mask	255.255.255.0
Default Gateway	192.168.210.254
Primary DNS	8.8.8.8
Secondary DNS	8.8.4.4
IPv6 PD Prefix	
IPv6 Domain Name	
IPv6 Primary DNS	
IPv6 Secondary DNS	
WAN Port Status	1000Mbps Full

1. TR069, VOICE, INTERNET, WAN Status

#### TR069\_VOICE\_INTERNET Vlan Status

Connection Type	DHCP
MAC Address	00:04:56:04:27:89
IP Address	10.110.134.15
Subnet Mask	255.255.255.0
Default Gateway	10.110.134.254
Primary DNS	10.110.12.30
Secondary DNS	10.110.12.31

#### VPN Status

VPN Type	Disable
Initial Service IP	
Virtual IP Address	

#### LAN Port Status

IP Address	192.168.11.1
Subnet Mask	255.255.255.0
LAN1	Link Down
LAN2	Link Down
LAN3	100Mbps Full
LAN4	Link Down



## Wireless Info

### Wireless 2.4GHz

Radio On/Off	On
Network Mode	11b/g/n
Current Channel	1
Channel Bandwidth	40MHz

### CAMBIUM\_2.4GHz\_042788

BSSID	00:04:56:04:27:88
Number of Device	0

### SSID2

BSSID	00:04:56:04:27:89
Number of Device	0

### SSID3

BSSID	00:04:56:04:27:8A
Number of Device	0

### SSID4

BSSID	00:04:56:04:27:8B
Number of Device	0

## System Status

### System Status

Current Time	2016-01-19 05:47:28
Elapsed Time	1 Min

Status	Network	Wireless	SIP	FXS1	FXS2	Security	Application	Storage	Administration
Basic	LAN Host	Syslog							

Refresh Clear Save

```

Manufacturer:CAMBIUM NETWORKS
ProductClass:cnPilot R200P
SerialNumber:
BuildTime:201711212052
IP:192.168.11.1
HWVer:V1.3
SWVer:4.3.4-R5
<Tue Nov 21 07:04:20 2017> DEV_MANAGER[13914]: Not able to find [ device_id ] in keystore
<Tue Nov 21 07:04:20 2017> DEV_MANAGER[13914]: Required on-boarding credentials not configured, cann...
<Tue Nov 21 07:04:20 2017> DEV_MANAGER[13914]: Unable to discover cnMaestro URL (re-discover in 68 s...
<Tue Nov 21 07:04:20 2017> DEV_MANAGER[13914]: Attempting (re)connection in 68 seconds
<Tue Nov 21 07:05:29 2017> DEV_MANAGER[13914]: Not able to find [ device_id ] in keystore
<Tue Nov 21 07:05:29 2017> DEV_MANAGER[13914]: Required on-boarding credentials not configured, cann...
<Tue Nov 21 07:05:29 2017> DEV_MANAGER[13914]: Unable to discover cnMaestro URL (re-discover in 73 s...
<Tue Nov 21 07:05:29 2017> DEV_MANAGER[13914]: Attempting (re)connection in 73 seconds
<Tue Nov 21 07:06:43 2017> DEV_MANAGER[13914]: Not able to find [ device_id ] in keystore
<Tue Nov 21 07:06:43 2017> DEV_MANAGER[13914]: Required on-boarding credentials not configured, cann...
<Tue Nov 21 07:06:43 2017> DEV_MANAGER[13914]: Unable to discover cnMaestro URL (re-discover in 65 s...
<Tue Nov 21 07:06:43 2017> DEV_MANAGER[13914]: Attempting (re)connection in 65 seconds
<Tue Nov 21 07:07:49 2017> DEV_MANAGER[13914]: Not able to find [ device_id ] in keystore
<Tue Nov 21 07:07:49 2017> DEV_MANAGER[13914]: Required on-boarding credentials not configured, cann...
<Tue Nov 21 07:07:49 2017> DEV_MANAGER[13914]: Unable to discover cnMaestro URL (re-discover in 76 s...
<Tue Nov 21 07:07:49 2017> DEV_MANAGER[13914]: Attempting (re)connection in 76 seconds
<Tue Nov 21 07:09:06 2017> DEV_MANAGER[13914]: Not able to find [ device_id ] in keystore
<Tue Nov 21 07:09:06 2017> DEV_MANAGER[13914]: Required on-boarding credentials not configured, cann...
<Tue Nov 21 07:09:06 2017> DEV_MANAGER[13914]: Unable to discover cnMaestro URL (re-discover in 303 ...
<Tue Nov 21 07:09:06 2017> DEV_MANAGER[13914]: Attempting (re)connection in 5 minutes
<Tue Nov 21 07:14:10 2017> DEV_MANAGER[13914]: Not able to find [ device_id ] in keystore
<Tue Nov 21 07:14:10 2017> DEV_MANAGER[13914]: Required on-boarding credentials not configured, cann...
<Tue Nov 21 07:14:10 2017> DEV_MANAGER[13914]: Unable to discover cnMaestro URL (re-discover in 341 ...
<Tue Nov 21 07:14:10 2017> DEV_MANAGER[13914]: Attempting (re)connection in 5 minutes

```

Table 9 :Status > Basic Page

Description
This webpage shows the status information about the Product, Network, and System including Product Information, SIP Account Status, FXS Port Status, Network Status and Wireless Info.

## Configuring an Internet Connection

In **Network > WAN** page, WAN connections may be inserted or deleted. For more information on *Internet Connection setting*, refer the Configuring an internet connection.

Status	Network	Wireless	SIP	FXS1	FXS2	Security	Application	Storage	Administration	
WAN	LAN	VPN	Port Forward	DMZ	DDNS	QoS	MAC Clone	Port Setting	Routing	Advance

**INTERNET**

**WAN**

Connect Name: 1\_TR069\_VOICE\_INTERNET\_R\_VID\_ [Delete Connect]

Service: TR069\_VOICE\_INTERNET

IP Protocol Version: IPv4

WAN IP Mode: Static

NAT Enable: Enable

VLAN Mode: Disable

VLAN ID: 1 (1-4094)

Static

IP Address: 192.34.30.69

Subnet Mask: 255.255.255.248

Default Gateway: 192.34.30.65

DNS Mode: Manual

Primary DNS Address: 66.185.0.68

Secondary DNS Address:

Port Bind

Port\_1     Port\_2     Port\_3     Port\_4

Wireless(SSID1)     Wireless(SSID2)     Wireless(SSID3)     Wireless(SSID4)

Note : WAN connection can not be shared between the binding port , and finally bound port WAN connections bind operation will wash away before the other WAN connection to the port binding operation !

**Help**

**WAN IP Mode:**

*Static IP* - Set the IP Address, Subnet Mask and Default Gateway that you have gotten from you ISP provider.

*DHCP* - You will get an IP Address,Subnet Mask and Default Gateway from some DHCP Server.

*PPPoE* - Set the PPPoE Account and PPPoE Password that you have gotten from your ISP provider.

Table 10 :Configuring an internet connection

Field Name	Description
Connect Name	Use keywords to indicate WAN port service model
Service	Chose the service mode for the created connection
IP Protocol Version	IPv4 and IPv6 are supported
WAN IP Mode	Choose Internet connection mode, DHCP, PPPoE, Static or Bridge
NAT Enable	Enable or disable NAT
VLAN ID	 <div style="background-color: #e6f2ff; padding: 5px; border: 1px solid #ccc;"> <p><b>Note</b></p> <p>Multiple WAN connections may be created with the same VLAN ID.</p> </div>
DNS Mode	<p>Select DNS mode, options are <b>Auto</b> and <b>Manual</b>:</p> <ul style="list-style-type: none"> <li>When DNS mode is Auto, the device under LAN port will automatically obtain the preferred DNS and alternate DNS.</li> </ul>

Field Name	Description
	<ul style="list-style-type: none"> <li>When DNS mode is Manual, the user should manually configure the preferred DNS and alternate DNS.</li> </ul>
Primary DNS	Enter the preferred DNS address
Secondary DNS	Enter the secondary DNS address
DHCP	(displayed when WAN IP Mode is set to DHCP)
DHCP Renew	Refresh the DHCP IP
DHCP Vendor (Option60)	<ul style="list-style-type: none"> <li>Specify the DHCP Vendor field</li> <li>Display the vendor and product name</li> </ul>

## Custom Factory Default Configuration

The cnPilot Home Router supports Custom Factory Default Configuration. This feature is available from release 4.5-R7 onwards. This feature allows user to generate their own customized default configuration file for the device(s). After the installation, this customized default configuration gets applied to the device each time after the device is factory reset. A TFTP server and SNMP browser are required to configure custom factory default. Recommended tool for TFTP server is **tftpd64** and for SNMP browser is **iReasoning MIB**. This setting can be done from either WAN or LAN. To configure factory default from WAN, select **Enable** from Remote **SNMP login** drop-down as show in following figure:

The screenshot shows the Cambium Networks web interface. At the top, there is a navigation bar with tabs for Status, Network, Wireless 2.4GHz, Wireless 5GHz, SIP, FXS1, FXS2, Security, Application, Storage, and Administration. The Administration tab is selected. Below this, there are sub-tabs for Management, Firmware Upgrade, Scheduled Tasks, Certificates, Provision, SNMP, TR069, Rflow, cnMaestro, and Diagnosis. The SNMP Configuration page is displayed, showing various settings. The 'Remote SNMP login' dropdown menu is highlighted with a red box and set to 'Enable'. Other settings include 'SNMP Service' (Enable), 'Trap Server Address', 'Read Community Name' (public), 'Write Community Name' (private), 'Trap Community' (trap), and 'Trap period interval(sec)' (300). A 'Help' section on the right explains that this setting allows the device to be managed by the Manager which is set in the SNMP Manager IP. At the bottom, there are 'Save', 'Cancel', and 'Reboot' buttons.

To load the customized default configuration file, perform the below steps:

1. Build your customized default configuration file by configuring a router through GUI.
2. Save the configuration and reboot the router.

3. Login to the router and export the configuration.
4. Load the exported configuration file and copy to the TFTP server.  
This becomes the custom default configuration.
5. Download **cambium-ata-mib** file from Cambium Networks support website:  
<https://support.cambiumnetworks.com/files/r-series/>
6. Open MIB browser and load **cambium-ata-mib** file.
7. On the left pane, expand **downloadConfig**.

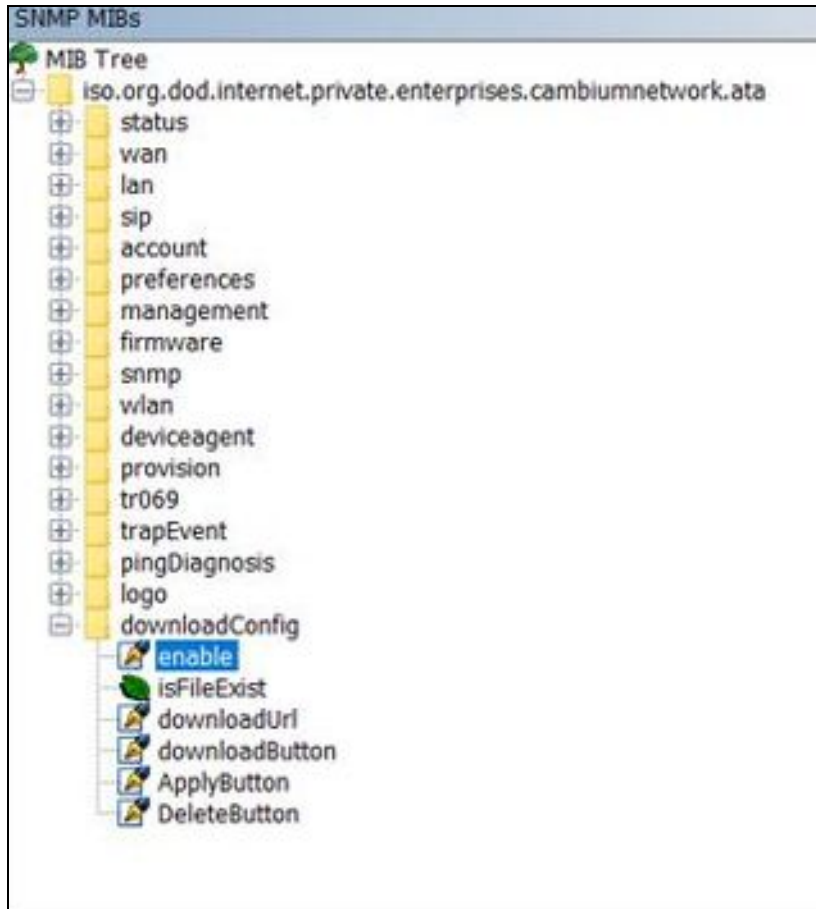

8. Double-click **enable** and type **1** in **value** to enable custom configuration file as factory default configuration.

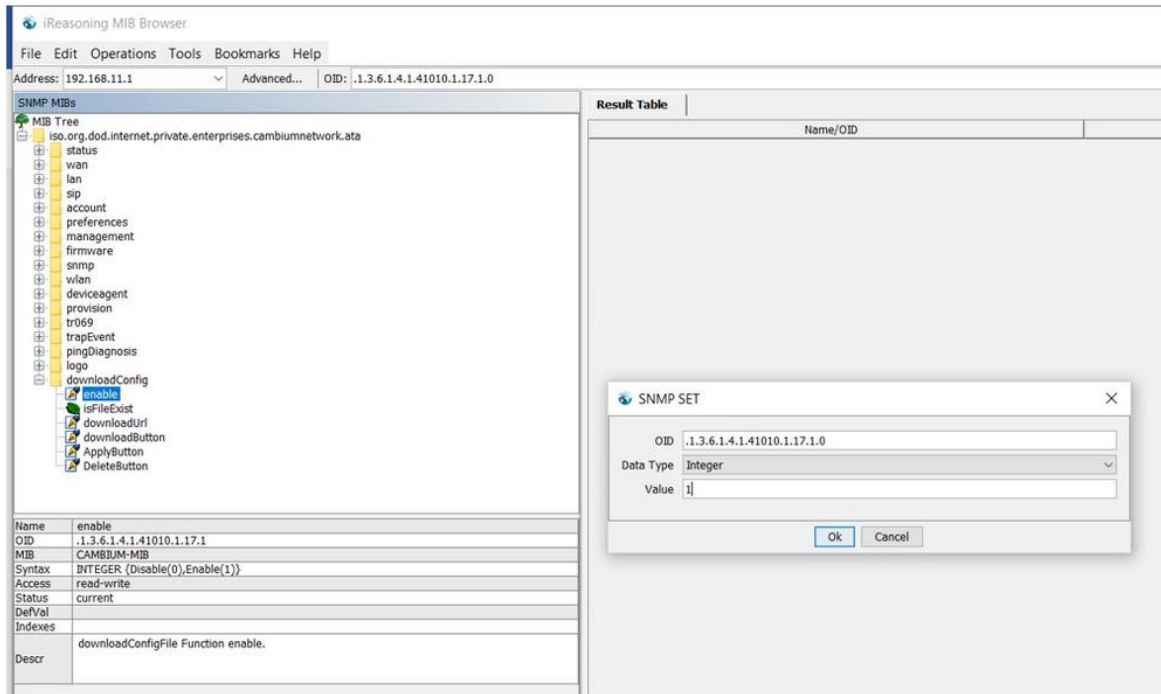

9. Double-click **downloadUrl** and provide the tftp custom configuration file location in **Value**.

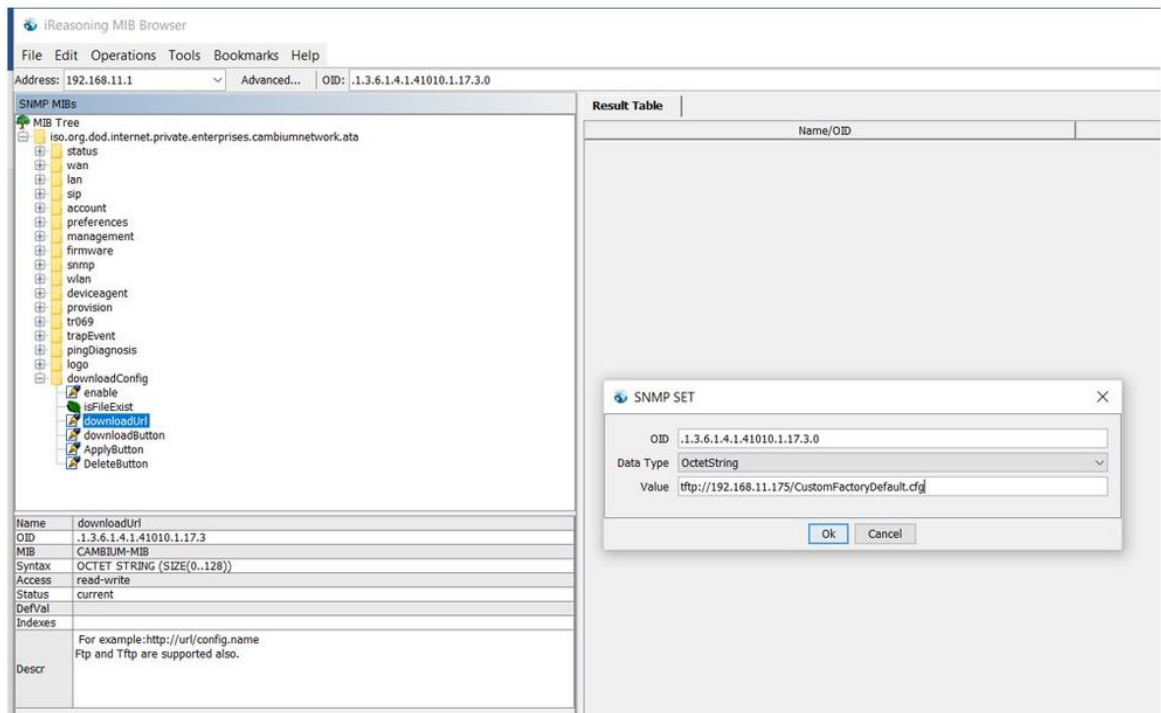

10. Double-click **downloadButton** and type **1** in **Value**.

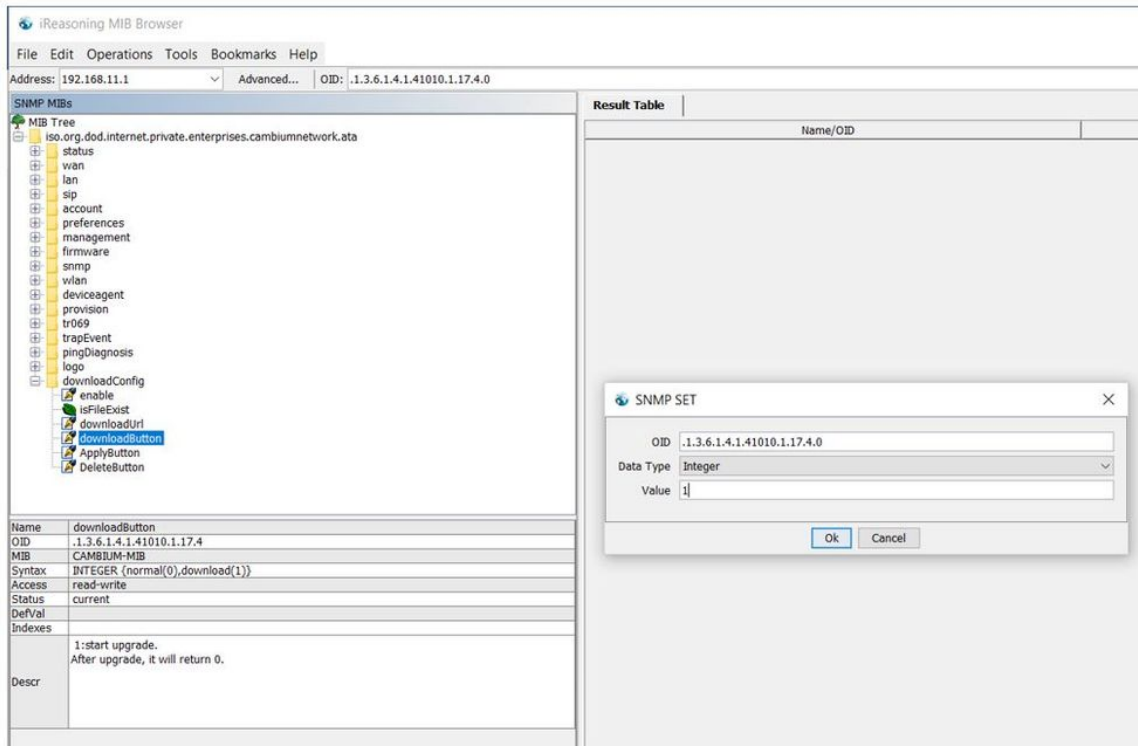

11. Double-click on **ApplyButton** and type 1 in Value.

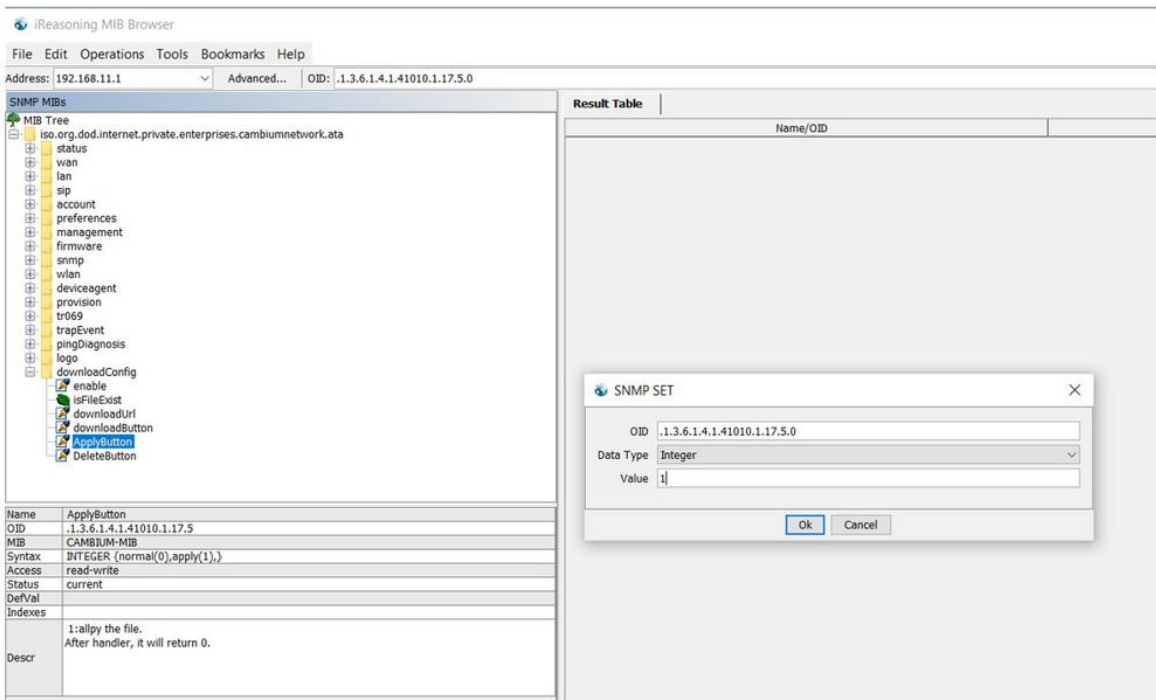

12. Reboot the router.

Router saves this configuration file as default factory settings. After reboot, router starts with this configuration.

To go back to Cambium Networks default factory reset settings, double-click **DeleteButton**, type **7** in **Value** and reboot the router. After reboot, router starts with Cambium Networks default factory reset settings.

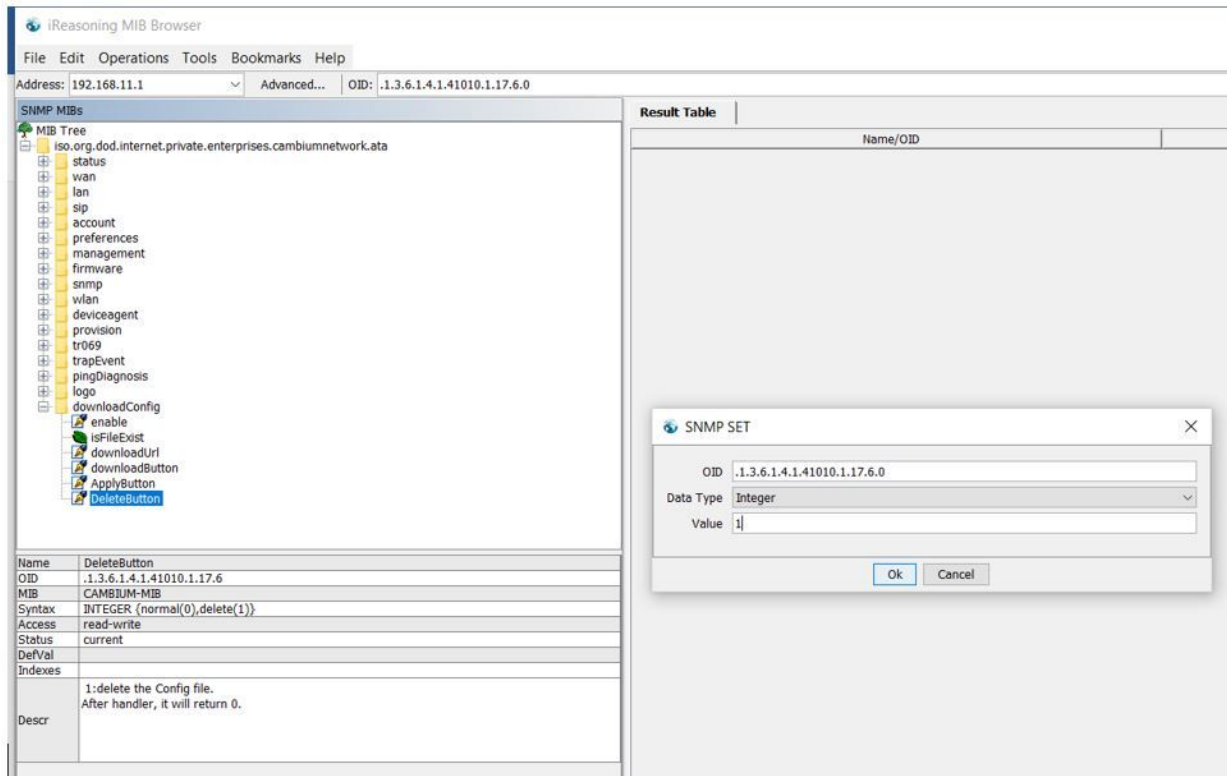

## Configuring as Range Extender / Wi Fi Repeater

cnPilot Home Router devices can be configured as wireless repeater and used as range extender. This feature can be used to extend the wireless networks in a big homes or places where the wireless coverage provided by the Base AP to be extended. This feature is also important for small and medium business establishments with only one internet drop point that can be used to connect only one Access Point and using the Repeater functionality internet coverage that can be extended to other areas.

### Repeater configuration

The first AP with wired internet link on WAN port is referred to as the **Base AP**. The AP that extends the internet link as a wireless extender, with no physical WAN port connection, is referred to as a **Repeater AP**. The Repeater AP connects with Base AP over the air. User devices are able to connect to Repeater and the Base SSIDs.

### Base AP configuration for repeater mode

Any R-series AP can act as a Base AP and can provide connectivity to another R-series Repeater AP. There is no special configuration required on the Base AP. Secure PSK based SSID - preferably on 5 GHz and configured with WPA2-PSK that can be used by the extender AP to connect.



## Repeater AP configuration

cnPilot R-series AP can be configured as Repeater AP and they can connect with the Base AP as WiFi extender to increase the coverage of existing Base AP's.

### Repeater AP configuration

1. Under **Wireless Network**, select **Repeater** from **Wireless Connection Mode** drop-down.

The screenshot shows the configuration interface for the Wireless 5GHz network. The 'Wireless Connection Mode' is set to 'Repeater'. The 'Network Mode' is '11vht AC/AN/A'. The 'Multiple SSID' is 'CAMBIUM\_5GHz\_0F04'. The 'Max Client' is set to 16. The 'Radio On/Off' is 'Radio On'. The 'Frequency (Channel)' is 'Auto'. The 'HT Physical Mode' is 'Auto'. The 'Repeater' tab is highlighted in the top navigation bar.

After configuring Wireless Connection Mode as Repeater, a new **Repeater** tab is added in the existing tabs under Wireless 2.4GHz or Wireless 5 GHz where the Repeater mode is selected.

The screenshot shows the configuration interface for the Wireless 5GHz network. The 'Wireless Connection Mode' is set to 'Repeater'. The 'Network Mode' is '11vht AC/AN/A'. The 'Multiple SSID' is 'NORTHSTAR5'. The 'Max Client' is set to 16. The 'Radio On/Off' is 'Radio On'. The 'Frequency (Channel)' is 'Auto'. The 'HT Physical Mode' is 'Auto'. The 'Repeater' tab is highlighted in the top navigation bar.

2. Click on the **Repeater** tab and check the available SSIDs with their Authentication and Encryption mode. Select SSID of your Base AP and press **Connect** to initiate the Repeater connection with Base AP.

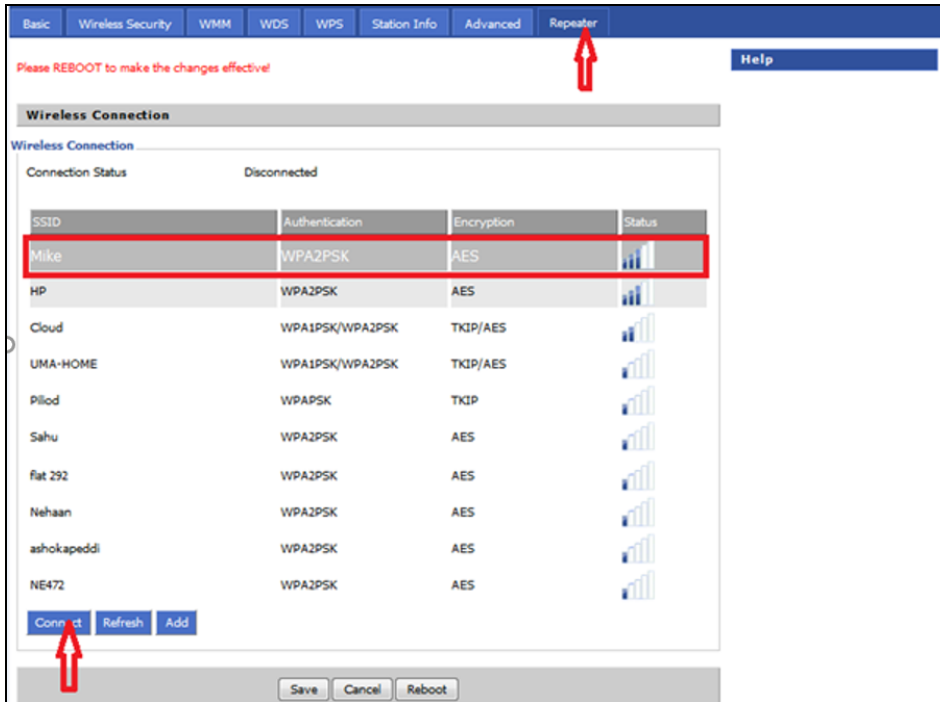

3. After selecting the Base AP SSID in the list of Available SSIDs, click **Connect**, an option to select **Authentication mode**, **Encryption type** and a text box to enter the password for the selected SSID are displayed.

After entering all the information click **OK** to make the Repeater mode connection with selected SSID.

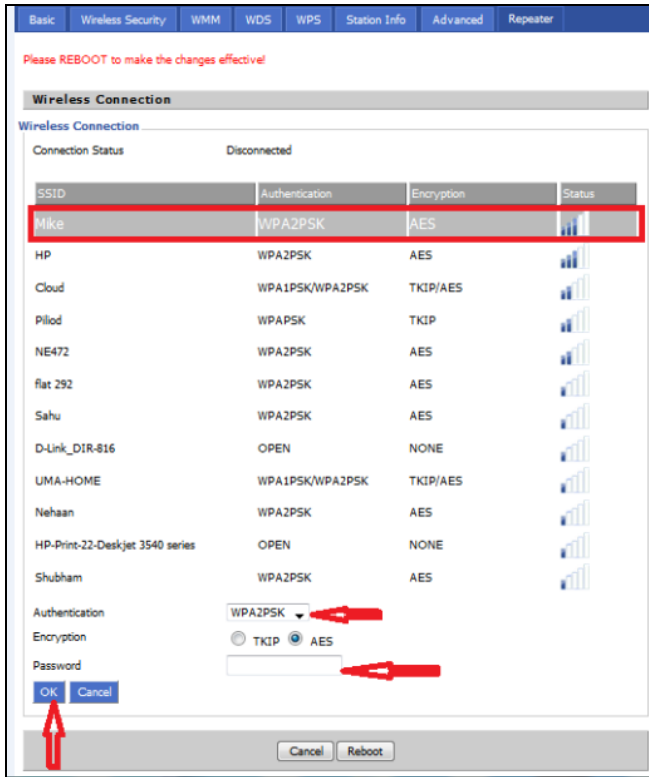

The Repeater link comes up. Verify the Connection Status as **Connected** and it also shows the name of SSID where it is connected.

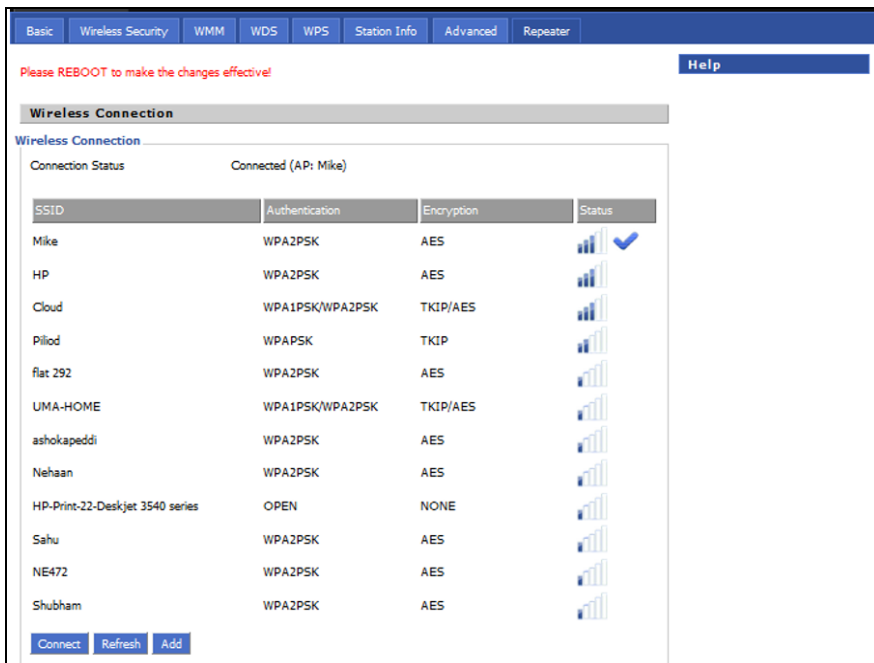

- Click **Save** to save the configurations and reboot the AP. After rebooting the Repeater AP, check that the Repeater Link is up with the Base AP SSID previously selected automatically.

Wireless Connection			
SSID	Authentication	Encryption	Status
Mike	WPA2PSK	AES	
HP	WPA2PSK	AES	
Cloud	WPA1PSK/WPA2PSK	TKIP/AES	
Pillod	WPA2PSK	TKIP	
NE472	WPA2PSK	AES	
Nehaan	WPA2PSK	AES	
ashokapeddi	WPA2PSK	AES	
UMA-HOME	WPA1PSK/WPA2PSK	TKIP/AES	
HP_202	WPA2PSK	AES	
Shubham	WPA2PSK	AES	
Sahu	WPA2PSK	AES	

## Repeater AP LAN IP/WAN IP changes

If both Base AP and Repeater AP has same LAN IP/range as **192.168.11.xx**, then Repeater AP's LAN IP range automatically changes to **192.168.12.xx** and Repeaters LAN IP will be 192.168.12.1. Repeater AP's WAN Port/internet port gets IP address from the configured LAN DHCP server of the Base AP.



### Note

If R-series device is configured as a Repeater, it changes from 192.168.11.x pool on the LAN side to 192.168.12.x pool. This sticks around unless we factory reset the Repeater AP. It is recommended not to swap the Base and Repeater AP configurations across devices. And if that is really required the user **MUST** factory reset the Repeater AP before using it elsewhere.

In the above configuration method, the repeater is in DHCP/NAT mode, hence the wireless client gets 192.168.12.x IP. Only limitation of this method is, any shared network resources, like printers, Sonos, NAS etc must be connected only to the primary/base AP in order to be accessible from all the clients. Clients/Devices connected to the Repeater AP cannot be accessed from client in the primary/base AP.

To unify all clients under a single subnet, configure the repeater AP with 2 WAN profiles:

1. Wan profile 1 : Service: Internet\_Voice WAN IP Mode: Bridge
2. Wan profile 2 : Service: Management WAN IP Mode: NAT/DHCP, also enable **Use Management Interface** under **Administration > cnMaestro**.

With this configuration all base and repeater's client is in single subnet **192.168.11.x** and able to access share resources.

Status **Network** Wireless 2.4GHz Wireless 5GHz SIP FXS1 FXS2 Security Application Storage Administration

WAN LAN IPv6 Advanced IPv6 LAN VPN Port Forward DMZ DDNS QoS Port Setting Routing Advance

Please REBOOT to make the changes effective!

**INTERNET**

**WAN**

Connect Name: 1\_VOICE\_INTERNET\_B\_VID [Delete Connect]

Service: VOICE\_INTERNET

IP Protocol Version: IPv4

WAN IP Mode: Bridge

Bridge Type: IP Bridge

DHCP Service Type: Pass Through

VLAN Mode: Disable

VLAN ID: 1 (1-4094)

Port Bind:

Port\_1  Port\_2  Port\_3  Port\_4

Wireless(SSID)  Wireless(SSID1)  Wireless(SSID2)  Wireless(SSID3)

Note: A port can be mapped to only a single WAN profile. If a port is selected in multiple WAN profiles then, only the most recent selection is retained.

**Help**

**WAN IP Mode:**

*Static IP* - Set the IP Address, Subnet Mask and Default Gateway that you have gotten from you ISP provider.

*DHCP* - You will get an IP Address,Subnet Mask and Default Gateway from some DHCP Server.

*PPPoE* - Set the PPPoE Account and PPPoE Password that you have gotten from your ISP provider.

*Route Mode* - To enable Route mode, please turn off 'NAT Enable'. Route Mode must not be used with Multi WAN configuration.

Status **Network** Wireless 2.4GHz Wireless 5GHz SIP FXS1 FXS2 Security Application Storage Administration

WAN LAN IPv6 Advanced IPv6 LAN VPN Port Forward DMZ DDNS QoS Port Setting Routing Advance

Please REBOOT to make the changes effective!

**INTERNET**

**WAN**

Connect Name: 2\_MANAGEMENT\_R\_VID [Delete Connect]

Service: MANAGEMENT

IP Protocol Version: IPv4

WAN IP Mode: DHCP

MAC Address Clone: Disable

NAT Enable: Enable

Overwrite NAT IP: [ ]

VLAN Mode: Disable

VLAN ID: 1 (1-4094)

DNS Mode: Auto

Primary DNS: [ ]

Secondary DNS: [ ]

DHCP

DHCP Renew: [Renew]

DHCP Vendor(Option 60): CAMBIUM-cnPilot R201P

**Help**

**WAN IP Mode:**

*Static IP* - Set the IP Address, Subnet Mask and Default Gateway that you have gotten from you ISP provider.

*DHCP* - You will get an IP Address,Subnet Mask and Default Gateway from some DHCP Server.

*PPPoE* - Set the PPPoE Account and PPPoE Password that you have gotten from your ISP provider.

*Route Mode* - To enable Route mode, please turn off 'NAT Enable'. Route Mode must not be used with Multi WAN configuration.

Status Network Wireless 2.4GHz Wireless 5GHz SIP FXS1 FXS2 Security Application Storage Administration

Management Firmware Upgrade Scheduled Tasks Certificates Provision SNMP TR069 Rflow cnMaestro Diagnosis

Operating Mode

Please REBOOT to make the changes effective!

**cnMaestro Configuration**

**Configuration**

Remote Management  Disable  Enable

IPv6 Preferred  Disable  Enable

Use Management Interface  Disable  Enable

cnMaestro URL

Connection Status **Connecting to cloud.cambiumnetworks.com in 1 minute**

**Credentials**

Cambium ID

Onboarding Key

AccountID

Save Cancel Reboot

**Help**

**cnMaestro Configuration:**  
Device can be managed remotely using Cambium Remote Management server

## Repeater mode best practices

1. If both Base AP and Repeater AP are dual band, then configure the Repeater AP to connect on 5 GHz and provide Client Connectivity or User Wireless Connectivity on 2.4 GHz/5 GHz.
2. Place the Repeater AP well within the range of the Base AP for a stable Repeater link.
3. The same radio on the Repeater AP, can be used to connect to the Base AP as extender and provide Wireless User Connectivity also. However with reduced bandwidth available for user traffic.
4. Creating multi hops of Repeater mode degrades performance, increase latency and it is not recommended.

## Network

You can configure the WAN port, LAN port, DDNS, Multi WAN, DMZ, MAC Clone, Port Forward and other parameters in this section of the web management interface.

### WAN

This page allows you to set WAN configuration with different modes. Use the Connection Type drop down list to choose one WAN mode and then the corresponding page will be displayed.



#### Note

By default, Management access over WAN is disabled for security concerns and can be enabled if required. For more information, refer Enabling Management access for wireless clients.

By default, SNMP access over WAN interface is disabled for security concerns and can be enabled if required. For more information, refer Enabling SNMP access over WAN.

## WAN Settings

Table 11 :Connect name

Content	Define	Description
Connect Name	1_MANAGEMENT_VOICE_INTERNET_R_VID	WAN Connection name
Delete Connect		To delete the selected connection name.
Service	VOICE	The connection solely supports VOICE service
	MANAGEMENT	The connection supports management applications i.e. TR069, WEB, SNMP and Provision
	INTERNET	The connection solely supports internet service
	MANAGEMENT_INTERNET	The connection supports management and internet applications
	MANAGEMENT_VOICE	The connection supports management and voice applications
	VOICE_INTERNET	The connection supports voice and internet applications
	MANAGEMENT_VOICE_INTERNET	The connection supports management, voice and internet applications
	Other	The connection support STB (Set Top Box).
IP Protocol Version	IPv4	Use protocol version Ipv4 for WAN Interface
	Ipv6	Use protocol version Ipv6 for WAN Interface
WAN IP Mode	STATIC	Set the IP address, Subnet Mask and Default Gateway from ISP provider
	DHCP	Provides IP address, Subnet Mask and Default Gateway from DHCP server
	PpoE	Set the PpoE account and PpoE password received from ISP provider
	Bridge	To enable Route Mode, please turn off 'NAT Enable'. Route Mode must not be used with Multi WAN Configuration
MAC Address Clone		Clone third party device MAC Address
NAT Enable		Enable Network Address Translation
Owerwrite NAT IP	<IP Address>	Overwrite NAT IP with given IP

Content	Define	Description
VLAN Mode	Enable	Enable VLAN Mode
	Trunk	Enable Trunk
VLAN ID	1-4094	Specify required VLAN ID
DNS Mode	Manual	Configure DNS servers manually
	Auto	Configure DNS servers automatically
DHCP Renew		Renew your DHCP IP
DHCP Vendor (Option 60)		Configure required DHCP Vendor Class name
Port Bind	LAN 1-4	Bind 1 or more LAN ports to the INTERNET WAN profile
	SSID 1-4	Bind 1 or more SSIDs to the INTERNET WAN profile

For example:

1\_TR069\_R\_VID\_2 (First Interface, Service is TR069, NAT Mode, VLAN ID is 2).

2\_INTERNET\_B\_VID (Second Interface, Service is INTERNET, Bridge Mode, VLAN is disabled).

## Overview

Multi WAN is used to implement the distribution of different kinds of services, and device's Multi WAN supports the distribution of data services, voice services and management services. By setting different VLANs, different kinds of data is distributed to the corresponding networks.

For example, INTERNET and Other VLAN supports data transmission, VOICE VLAN supports voice transmission and TR069 VLAN supports WEB, Telnet and TR069 services transmission.

Figure 1: Multi VLAN



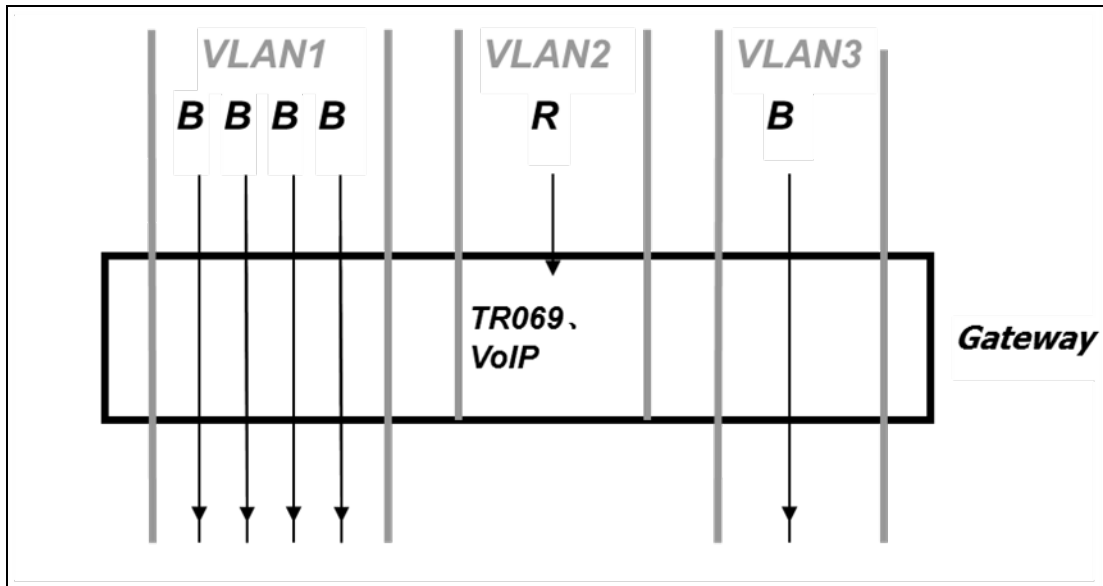

There are several advanced functions available when using Multi WAN setting:

- PPPoE Bridge allows PPPoE-only packets to pass, which can prohibit Layer 2 packets from flooding the device LAN ports.
- Hardware Bridge operates as a Layer 2 Switch to increase throughput between WAN and LAN.
- VLAN Trunk allows tagged packets to be switched to LAN ports directly.
- IPTV may be supported with other VLAN-configured LAN ports.
- Multiple WAN link (i.e. Connect Name) can be configured with same VLAN ID.

Figure 2 : Multi WAN network

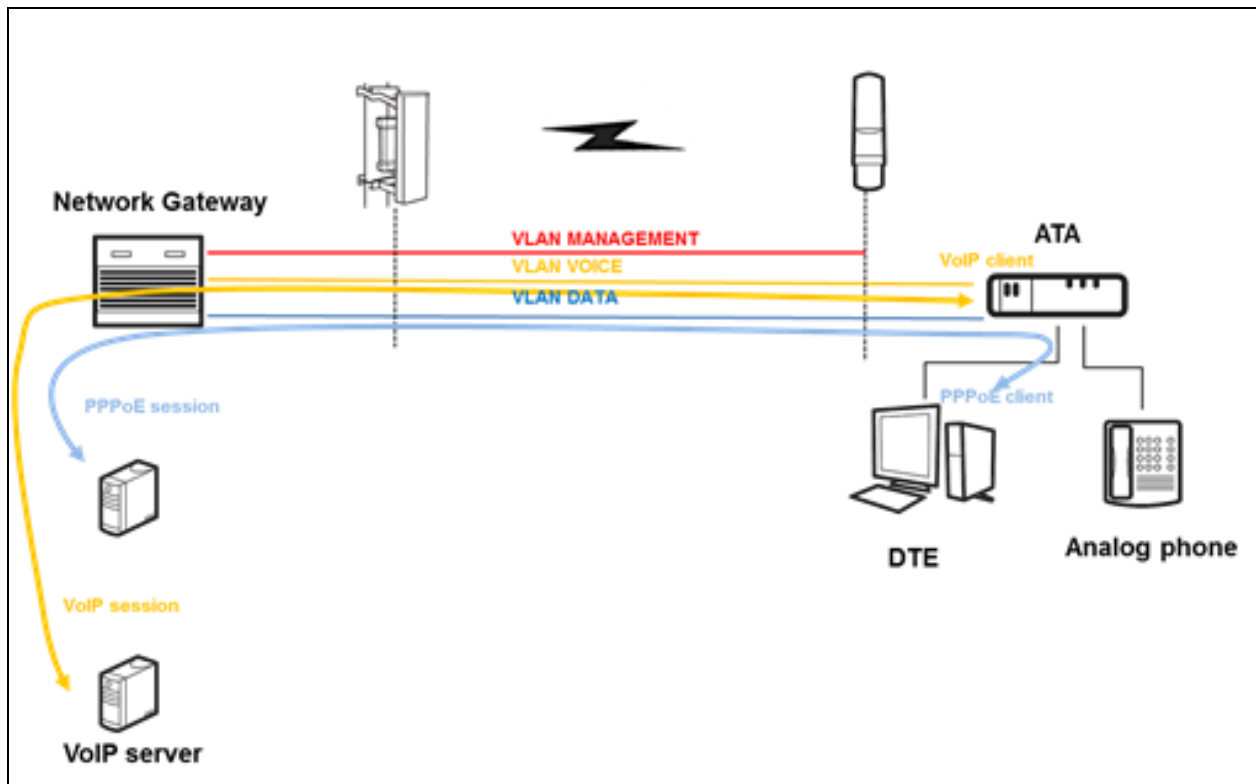

## Change in Port Binding behaviour

Starting version 4.4 of the Cambium cnPilot R-series software a fix was introduced related to the port binding. This change requires, that users creating non-default WAN INTERNET profiles, **MUST** explicitly select/bind one or more LAN ports and/or SSIDs, to the created INTERNET WAN profile as per need. Software before 4.4 had an issue, where in such situations all ports/WLANs were automatically bound to such an INTERNET WAN profile created by the users.

Users running 4.3.4 or lower software and upgrading to 4.4 or newer software, **MUST** ensure that they update their port binding configuration by explicitly selecting one or more LAN ports and/or SSIDs, before upgrading, to avoid problems related to Internet access from LAN/WLAN clients.

Customers using default WAN profile remain unaffected. Also, customers using non-default WAN profile who have explicitly bound their required LAN ports and/or SSIDs to their INTERNET WAN profile will experience no problems after upgrade.

When creating a new INTERNET WAN profile please select one or more LAN ports and/or SSIDs as shown below:

Status	Network	Wireless 2.4GHz	Wireless 5GHz	SIP	FXS1	FXS2	Security	Application		
WAN	LAN	IPv6 Advanced	IPv6 LAN	VPN	Port Forward	DMZ	DDNS	QoS	Port Setting	Router

**INTERNET**

**WAN**

Connect Name: New Connection Delete Connect

Service: INTERNET

IP Protocol Version: IPv4

WAN IP Mode: DHCP

MAC Address Clone: Disable

NAT Enable: Enable

Overwrite NAT IP:

VLAN Mode: Disable

VLAN ID:  (1-4094)

DNS Mode: Auto

Primary DNS:

Secondary DNS:

DHCP

DHCP Renew:

DHCP Vendor(Option 60):

**Port Bind** (bordered in red)

<input checked="" type="checkbox"/> Port_1	<input checked="" type="checkbox"/> Port_2	<input type="checkbox"/> Port_3	<input type="checkbox"/> Port_4
<input checked="" type="checkbox"/> Wireless(SSID)	<input checked="" type="checkbox"/> Wireless(SSID1)	<input type="checkbox"/> Wireless(SSID2)	<input type="checkbox"/> Wireless(SSID3)

## Static IP

This configuration may be utilized when a user receives a fixed public IP address or a public subnet, namely multiple public IP addresses from the Internet providers. In most cases, a Cable service provider will offer a fixed public IP, while a DSL service provider will offer a public subnet. If you have a public subnet, you can assign an IP address to the WAN interface.

Table 12 :Internet

<b>Static</b>	
IP Address	<input type="text" value="192.34.30.69"/>
Subnet Mask	<input type="text" value="255.255.255.248"/>
Default Gateway	<input type="text" value="192.34.30.65"/>
DNS Mode	<input type="text" value="Manual"/>
Primary DNS Address	<input type="text" value="66.185.0.68"/>
Secondary DNS Address	<input type="text"/>
<b>Content</b>	<b>Define</b>
IP Address	The IP address of Internet port
Subnet Mask	The subnet mask of Internet port
Default Gateway	The default gateway of Internet port
DNS Mode	Select DNS mode, options are Auto and Manual.
Primary DNS Address	The primary DNS of Internet port
Secondary DNS Address	The secondary DNS of Internet port

## DHCP

The DHCP feature allows the cnPilot Home Router to obtain an IP address automatically from a DHCP server. In this case, it is not necessary to assign an IP address to the client manually.

INTERNET	
<b>WAN</b>	
Connect Name	1_MANAGEMENT_VOICE_INTERNET_B_VID <span>Delete Connect</span>
Service	MANAGEMENT_VOICE_INTERNET
IP Protocol Version	IPv4
WAN IP Mode	DHCP
MAC Address Clone	Disable
NAT Enable	Enable
Overwrite NAT IP	
VLAN Mode	Disable
VLAN ID	1 (1-4094)
DNS Mode	Auto
Primary DNS	15.1.1.2
Secondary DNS	
DHCP	
DHCP Renew	<span>Renew</span>
DHCP Vendor(Option 60)	CAMBIUM-cnPilot R200f
Port Bind	
<input checked="" type="checkbox"/> Port_1	<input checked="" type="checkbox"/> Port_2
<input checked="" type="checkbox"/> Port_3	<input checked="" type="checkbox"/> Port_4
<input checked="" type="checkbox"/> Wireless(SSID)	<input checked="" type="checkbox"/> Wireless(SSID1)
<input checked="" type="checkbox"/> Wireless(SSID2)	<input checked="" type="checkbox"/> Wireless(SSID3)
<p>Note: A port can be mapped to only a single WAN profile. If a port is selected in multiple WAN profiles then, only the most recent selection is retained.</p>	
<p><i>Static IP</i> - Set the IP Address, Subnet Mask and Default Gateway that you have gotten from you ISP provider.</p>	
<p><i>DHCP</i> - You will get an IP Address,Subnet Mask and Default Gateway from some DHCP Server.</p>	
<p><i>PPPoE</i> - Set the PPPoE Account and PPPoE Password that you have gotten from your ISP provider.</p>	

Table 13 :DHCP

Field Name	Description
DNS Mode	Select DNS mode, options are Auto and Manual.
Primary DNS Address	Primary DNS of Internet port.
Secondary DNS Address	Secondary DNS of Internet port.
DHCP Renew	Refresh the DHCP IP address
DHCP Vendor (Option60)	Specify the DHCP Vendor field. Display the vendor and product name.

## PPPoE

PPPoE stands for Point-to-Point Protocol over Ethernet. It relies on two widely accepted standards: PPP and Ethernet. It connects users through an Ethernet to the Internet with a common broadband medium, such as a single DSL line, wireless device or cable modem. All the users over the Ethernet can share a common connection.

PPPoE is used for most of DSL modem users. All local users can share one PPPoE connection for accessing the Internet. Your service provider will provide you information about username, password, and authentication mode.

INTERNET

**WAN**

Connect Name	1_MANAGEMENT_VOICE_INTERNET_R_VID ▾	<input type="button" value="Delete Connect"/>
Service	MANAGEMENT_VOICE_INTERNET ▾	
IP Protocol Version	IPv4 ▾	
WAN IP Mode	PPPoE ▾	
MAC Address Clone	Disable ▾	
NAT Enable	Enable ▾	
Overwrite NAT IP	<input type="text"/>	
VLAN Mode	Disable ▾	
VLAN ID	1 <small>(1-4094)</small>	
DNS Mode	Auto ▾	
Primary DNS	<input type="text"/>	
Secondary DNS	<input type="text"/>	
<b>PPPoE</b>		
PPPoE Account	<input type="text"/>	
PPPoE Password	••••••••	
Confirm Password	••••••••	
Service Name	<input type="text"/>	
	Leave empty to autodetect	
Operation Mode	Keep Alive ▾	
Keep Alive Redial Period(0-3600s)	5	

Table 14 :PPPoE

Field Name	Description
PPPoE Account	Enter a valid username provided by the ISP
PPPoE Password	Enter a valid password provided by the ISP.
Confirm Password	Enter your PPPoE password again.
Service Name	Enter a service name for PPPoE authentication. If it is left empty, the service name is auto detected.
Operation Mode	Select the mode of operation, options are Keep Alive, On Demand and Manual:  When the mode is Keep Alive, the user sets the 'keep alive redial period' values range from 0 to 3600s, the default setting is 5 minutes;  When the mode is On Demand, the user sets the 'on demand idle time' value in the range of 0-60 minutes, the default setting is 5

Field Name	Description
	minutes; <div style="border: 1px solid black; padding: 5px; margin: 5px 0;">             Operation Mode <span style="float: right;">On Demand ▾</span>              On Demand Idle Time(0-60m) <span style="float: right;">5</span> </div> When the mode is Manual, there are no additional settings to configure
Keep Alive Redial Period	Set the interval to send Keep Alive messaging.

## Bridge Mode

Bridge Mode under Multi WAN is different with traditional bridge setting. Bridge mode employs no IP addressing and the device operates as a bridge between the WAN port and the LAN port. Route Connection must be built to give IP address to local service on device.

Following is an example of bridge mode:

1. TR069\_VOICE\_INTERNET\_R\_VID\_ is router connection for local service.
2. Other\_B\_VID\_ is bridge connection for host of LAN port.

**INTERNET**

**WAN**

Connect Name: 1\_MANAGEMENT\_VOICE\_INTERNET\_R\_VID ▾ Delete Connect

Service: MANAGEMENT\_VOICE\_INTERNET ▾

IP Protocol Version: IPv4 ▾

WAN IP Mode: Bridge ▾

Bridge Type: IP Bridge ▾

DHCP Service Type: Pass Through ▾

VLAN Mode: Disable ▾

VLAN ID: 1 (1-4094)

Port Bind

Port\_1     
  Port\_2     
  Port\_3     
  Port\_4  
 Wireless(SSID1)   
  Wireless(SSID2)   
  Wireless(SSID3)   
  Wireless(SSID4)

Note : WAN connection can not be shared between the binding port , and finally bound port WAN connections bind operation will wash away before the other WAN connection to the port binding operation !

Table 15 : Bridge Mode

Field Name	Description
<b>Bridge Type</b>	
IP Bridge	Allow all Ethernet packets to pass. PC can connect to upper network directly.
PPPoE Bridge	Only Allow PPPoE packets pass. PC needs PPPoE dial-up software.
Hardware IP Bridge	Packets pass through hardware switch with wired speed. Does not support wireless port binding.
<b>DHCP Service Type</b>	
Pass Through	DHCP packets can be forwarded between WAN and LAN, DHCP server in gateway will not allocate IP to clients of LAN port.
DHCP Snooping	When gateway forwards DHCP packets form LAN to WAN it will add option82 to DHCP packet, and it will remove option82 when forwarding DHCP packet from the WAN interface to the LAN interface. Local DHCP service will not allocate IP to clients of LAN port.
Local Service	Gateway will not forward DHCP packets between LAN and WAN, it also blocks DHCP packets from the WAN port. Clients connected to the LAN port can get IP from DHCP server run in gateway.
<b>VLAN Mode</b>	
Disable	The WAN interface is untagged. LAN is untagged.
Enable	The WAN interface is tagged. LAN is untagged.
Trunk	Only valid in bridge mode. All ports, including WAN and LAN, belong to this VLAN id and all ports are tagged with this VLAN id. Tagged packets can pass through WAN and LAN.
VLAN ID	Set the VLAN ID.
	 <div style="border: 1px solid black; background-color: #e1f5fe; padding: 5px; display: inline-block;"> <p><b>Note</b> Multiple WAN connections may be created with the same VLAN ID.</p> </div>
802.1p	Set the priority of VLAN, Options are 0-7.

## Q-in-Q

Q-in-Q tunneling allow service providers to create a Layer 2 Ethernet connection between two customer sites. Providers can segregate different customers' VLAN traffic on a link (for example, if the customers use overlapping VLAN IDs) or bundle different customer VLANs into a single service VLAN. Data centers can use Q-in-Q tunneling to isolate customer traffic within a single site or to enable customer traffic flows between cloud data centers in different geographic locations. Q-in-Q tunneling adds a service VLAN tag (802.1Q based) before the customer's 802.1Q VLAN tags.

In Q-in-Q tunneling, as a packet travels from a customer VLAN (C-VLAN) to a service provider's or data center VLAN (S-VLAN), another 802.1Q tag for the appropriate S-VLAN is added before the C-VLAN tag. The C-VLAN tag remains and is transmitted through the network. As the packet leaves the S-VLAN in the downstream direction, the S-VLAN 802.1Q tag is removed.

Figure 3 : Q-in-Q Frame Format



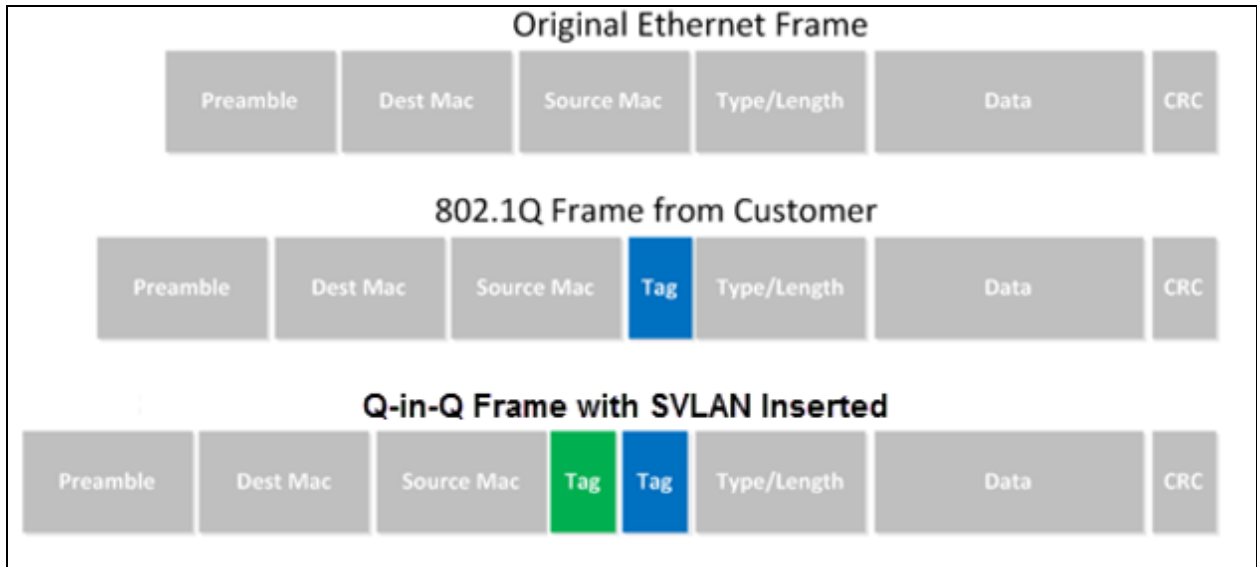
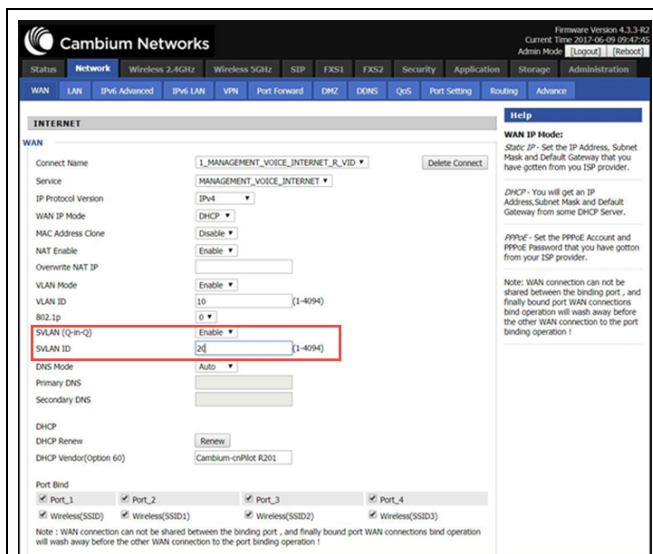

Table 16 :Q-in-Q



Field Name	Description
VLAN Mode	Enable VLAN Mode.
SVLAN(Q-in-Q)	Enable Q-in-Q feature.
SVLAN ID	Enter a value for SVLAN ID (1-4094).



**Note**

Ensure that **Hardware NAT Enable** option is disabled in the LAN page for R201/R201P/R201W models. The Hardware NAT Enable option is available only for R201 models. See the following image:

WAN	LAN	IPv6 Advanced	IPv6 LAN	VPN	Port Forward	DMZ	DDNS	QoS	Port Setting	Routing	Advance	
<b>PC Port(LAN)</b>											<b>Help</b>	
<b>PC Port(LAN)</b>											<b>PC Port(LAN):</b>	
Local IP Address											192.168.11.1	
Local Subnet Mask											255.255.255.0	
Local DHCP Server											Enable ▾	
DHCP Start Address											192.168.11.2	
DHCP End Address											192.168.11.254	
DNS Mode											Manual ▾	
Primary DNS											192.168.11.1	
Secondary DNS											8.8.8.8	
Client Lease Time(0-86400s)											86400	
											DHCP Client List	
DHCP Static Allotment												
NO.											MAC	IP Address
Delete Selected											Add	Edit
DNS Proxy											Enable ▾	
Hardware NAT Enable											Disable ▾	
											<b>PC Port(LAN):</b>	
											<i>NAT</i> - The product will be same as a router.	
											<i>Bridge</i> - The LAN port is same as WAN port.	
											<i>Local DHCP Server</i> - It will assign IP Addressed set here to devices connect to the LAN port.	

## Route Mode

Route Mode is an additional mode of operation for the device. In order to setup Route Mode operation, NAT Enable must be turned off. This feature cannot be used with Multi-WAN configuration.

INTERNET

**WAN**

Connect Name	1_MANAGEMENT_VOICE_INTERNET_R_VID ▾	Delete Connect
Service	MANAGEMENT_VOICE_INTERNET ▾	
IP Protocol Version	IPv4 ▾	
WAN IP Mode	DHCP ▾	
MAC Address Clone	Disable ▾	
NAT Enable	Disable ▾	
Route Enable	Disable ▾	
Overwrite NAT IP	Disable <input type="text"/> Enable <input type="text"/>	
VLAN Mode	Disable ▾	
VLAN ID	1 (1-4094)	
DNS Mode	Auto ▾	
Primary DNS	<input type="text"/>	
Secondary DNS	<input type="text"/>	
DHCP		
DHCP Renew	<input type="button" value="Renew"/>	
DHCP Vendor(Option 60)	<input type="text" value="Cambium-cnPilot R201"/>	
Port Bind		
<input checked="" type="checkbox"/> Port_1	<input checked="" type="checkbox"/> Port_2	<input checked="" type="checkbox"/> Port_3 <input checked="" type="checkbox"/> Port_4

NAT Enable	Disable ▾	
Route Enable	Disable ▾	
Overwrite NAT IP	Disable <input type="text"/> Enable <input type="text"/>	
VLAN Mode	Disable ▾	





**NAT Enable** must be Disabled for **Route Enable** to setup.

## MAC Clone

Some ISPs will require you to register your MAC address. If you do not wish to re-register your MAC address, you can have the router clone the MAC address that is registered with your ISP. To use the Clone Address button, the computer accessing the web management interface will have the MAC address automatically entered in the Clone WAN MAC field.

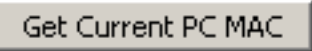
Status	Network	Wireless 2.4GHz	Wireless 5GHz	SIP	FXS1	FXS2	Security	Application	Storage	Administration	
WAN	LAN	IPv6 Advanced	IPv6 LAN	VPN	Port Forward	DMZ	DDNS	QoS	Port Setting	Routing	Advance
<b>INTERNET</b>											
<b>WAN</b>											
Connect Name	1_MANAGEMENT_VOICE_INTERNET_R_VID			Delete Connect							
Service	MANAGEMENT_VOICE_INTERNET										
IP Protocol Version	IPv4										
WAN IP Mode	DHCP										
MAC Address Clone	Enable										
MAC Address				Get Current PC MAC							
NAT Enable	Enable										
Overwrite NAT IP											
VLAN Mode	Disable										
VLAN ID	1			(1-4094)							
DNS Mode	Auto										
Primary DNS	172.16.5.200										
Secondary DNS											
DHCP											
DHCP Renew	Renew										
DHCP Vendor(Option 60)	Cambium-cnPilot R201P										
Port Bind											
<input checked="" type="checkbox"/> Port_1	<input checked="" type="checkbox"/> Port_2	<input checked="" type="checkbox"/> Port_3	<input checked="" type="checkbox"/> Port_4								
<input checked="" type="checkbox"/> Wireless(SSID)	<input checked="" type="checkbox"/> Wireless(SSID1)	<input checked="" type="checkbox"/> Wireless(SSID2)	<input checked="" type="checkbox"/> Wireless(SSID3)								
<b>Help</b>											
<b>WAN IP Mode:</b>											
<i>Static IP</i> - Set the IP Address, Subnet Mask and Default Gateway that you have gotten from you ISP provider.											
<i>DHCP</i> - You will get an IP Address,Subnet Mask and Default Gateway from some DHCP Server.											
<i>PPPoE</i> - Set the PPPoE Account and PPPoE Password that you have gotten from your ISP provider.											

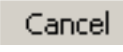
Table 17 :MAC clone

Procedure
1. Press the button  gets PC's MAC address
2. Press the button  to save your changes if users don't want to use MAC clone, press the button  to cancel the changes
3. Press the button  to make the changes effective.

### Fast Bridge Setting

Step 1	Login to the web management interface of the cnPilot Home Router. Navigate to Page <b>Administration &gt; Operating Mode</b> . Set <b>Operating mode</b> to <b>Basic Mode</b> . Click <b>Save</b> .
--------	---

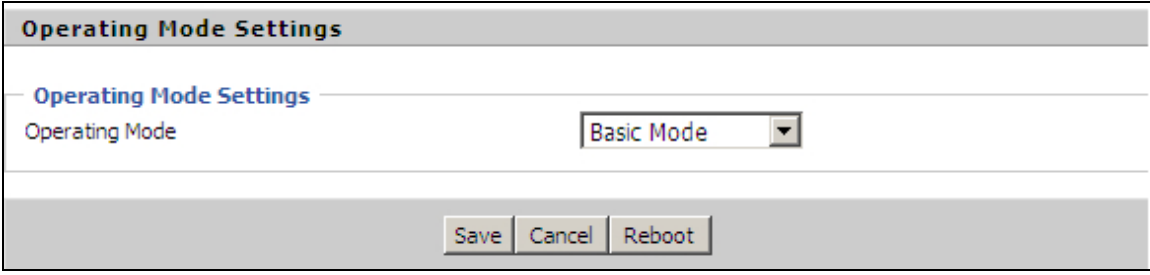
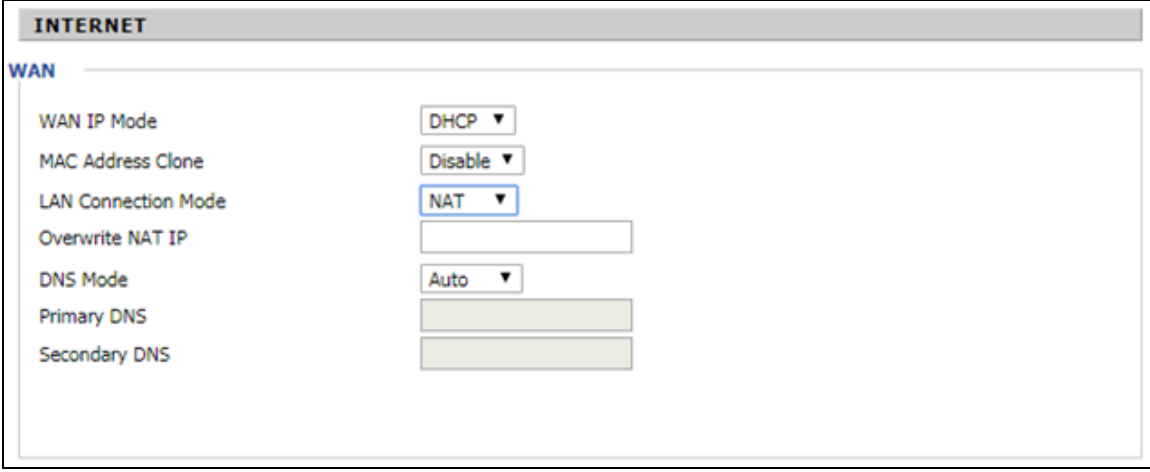
	
<p>Step 2</p>	<p>Open <b>Network &gt; WAN</b> change NAT Enable to Disable. Click <b>Save</b> and then <b>Reboot</b>. The device is now operating in Bridge mode.</p> 
<p>Step 3</p>	<p>Log into the device. Below is example of Page <b>Status &gt; Basic</b> displaying device configuration.</p>

<b>TR069_VOICE_INTERNET Vlan Status</b>	
Connection Type	DHCP
MAC Address	00:21:F2:14:08:13
IP Address	192.168.10.225
Subnet Mask	255.255.255.0
Default Gateway	192.168.10.1
Primary DNS	192.168.10.1
Secondary DNS	
<b>Other Vlan Status</b>	
Connection Type	Bridge
MAC Address	
IP Address	
Subnet Mask	
Default Gateway	
Primary DNS	
Secondary DNS	
<b>VPN Status</b>	
VPN Type	Disable
Initial Service IP	
Virtual IP Address	
<b>PC Port Status</b>	
IP Address	192.168.0.1
Subnet Mask	255.255.255.0
Port Status	Link Down

## IPv6 address configuration

The **cnPilot Home Router** devices support IPv6 addressing starting from Firmware version 4.3.

This section covers:

- Introduction to Ipv6
- Enabling IPv6
- Configuring IPv6
- Viewing WAN port status
- Ipv6 DHCP configuration for LAN/WLAN clients
- LAN DHCPv6

## Introduction to Ipv6

DHCPv6 protocol is used to automatically provision/configure Ipv6 capable end points in a local network. In addition to acquiring an Ipv6 IP address for the WAN interface and its associated LAN/WLAN clients, the cnPilot Home Router devices are also capable of prefix delegation.

The cnPilot Home Router devices support the following types of modes of Ipv6 addresses:

- Stateless DHCPv6
- Statefull DHCPv6

Table 18 :Ipv6 Modes

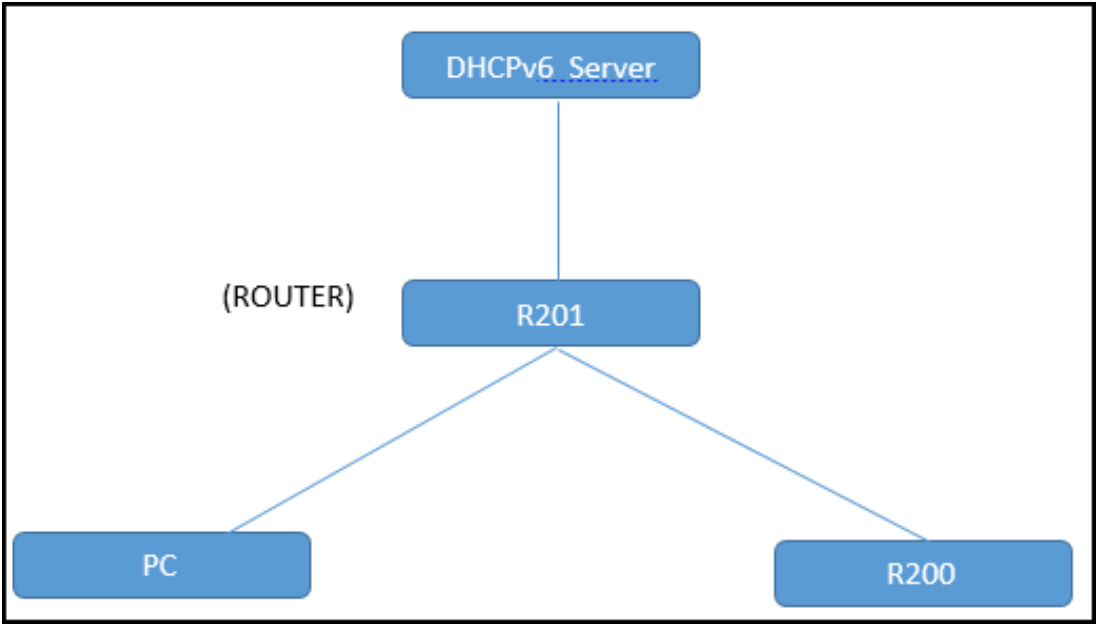
Mode	Description
Stateless	<p>In Stateless DHCPv6 mode, the cnPilot Home Router listen for ICMPv6 Router Advertisements messages which are periodically sent out by the routers on the local link or requested by the node using a Router Advertisements solicitation message. The device derives a unique Ipv6 address using prefix receives from the router and its own MAC address.</p>  <pre> graph TD     Server[DHCPv6 Server] --- R201[R201]     R201 --- PC[PC]     R201 --- R200[R200]     </pre>
Statefull	<p>In Statefull DHCPv6 mode, the client works exactly as Ipv4 DHCP, in which hosts receive both their Ipv6 addresses and additional parameters from the DHCP server.</p>

## Enabling IPv6

To enable Ipv6 functionality:

1. Navigate to **Network > IPv6** Advanced page.
2. Select **Enable** from the IPv6 Enable drop-down list.
3. Click **Save**.

Table 19 :Enabling IPv6

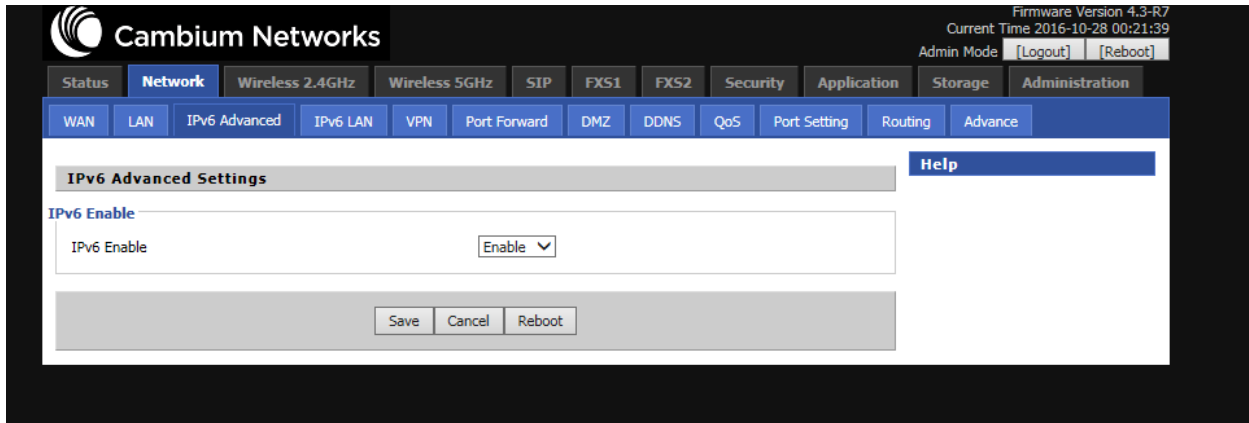

## Configuring IPv6

### Configuring Statefull IPv6

Navigate to **Network** > **WAN** page. The following window is displayed:

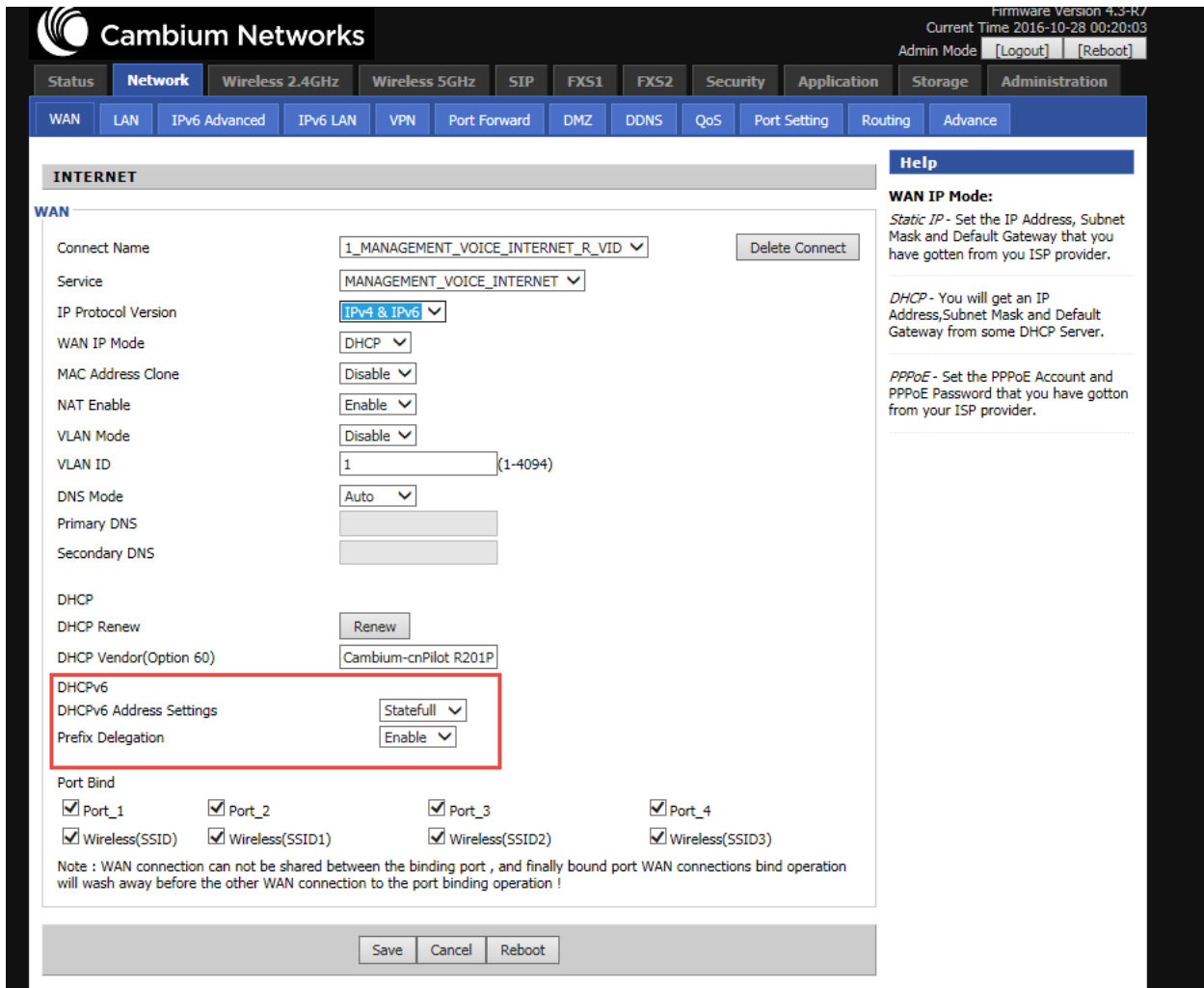

Table 20 :Configuring Statefull Ipv6



Field Name	Description
IP Protocol Version	Enable IPv4 and IPv6 option.
WAN IP Mode	Set it to <b>DHCP</b> .
NAT Enable	Select <b>Enable</b> .
DHCPv6 Address Settings	Set it to <b>Statefull</b> mode.
Prefix Delegation	Select <b>Enable</b> .

## Configuring Stateless Ipv6

To configure Stateless Ipv6, see the following image:

The screenshot shows the Cambium Networks web interface for configuring WAN settings. The 'INTERNET' tab is selected, and the 'WAN' section is expanded. The 'DHCPv6' section is highlighted with a red box, showing the following settings:

- DHCPv6 Address Settings: Stateless
- Prefix Delegation: Enable

Other visible settings include:

- Connect Name: 1\_MANAGEMENT\_VOICE\_INTERNET\_R\_VID
- Service: MANAGEMENT\_VOICE\_INTERNET
- IP Protocol Version: IPv4 & IPv6
- WAN IP Mode: DHCP
- MAC Address Clone: Disable
- NAT Enable: Enable
- VLAN Mode: Disable
- VLAN ID: 1 (1-4094)
- DNS Mode: Auto
- DHCP Renew: Renew
- DHCP Vendor(Option 60): Cambium-cnPilot R201P

At the bottom, there are 'Save', 'Cancel', and 'Reboot' buttons. A note at the bottom states: "Note : WAN connection can not be shared between the binding port , and finally bound port WAN connections bind operation will wash away before the other WAN connection to the port binding operation !"

Table 21 :Configuring Stateless Ipv6

Field Name	Description
IP Protocol Version	Enable Ipv4 and Ipv6 option.
WAN IP Mode	Set it to DHCP.
NAT Enable	Select Enable.
DHCPv6 Address Settings	Set it to stateless mode.
Prefix Delegation	Select Enable.

## Viewing WAN port status

To view the status of WAN port:

Navigate to Status page.

The screenshot displays the router's status page, divided into two main sections: FXS Port Status and Network Status.

**FXS Port Status**

FXS 1 Hook State	On
FXS 1 Port Status	Idle
FXS 2 Hook State	On
FXS 2 Port Status	Idle

**Network Status**

**Internet Port Status**

Connection Type	DHCP
IP Address	<input type="button" value="Renew"/>
Link-Local IPv6 Address	fe80::204:56ff:fe04:b001/64
IPv6 Address	<b>fec0::102/64</b>
Subnet Mask	255.255.255.0
Default Gateway	
Primary DNS	
Secondary DNS	
IPv6 PD Prefix	2001:db8:5eeb::/48
IPv6 Domain Name	domain.example
IPv6 Primary DNS	fec0::105
IPv6 Secondary DNS	fec0::106
WAN Port Status	1000Mbps Full

**1 TR069\_VOICE\_INTERNET Vlan Status**

Connection Type	
MAC Address	00:04:56:04:B0:01
IP Address	

## IPv6 DHCP configuration for LAN/WLAN clients

Wired and wireless clients connected to cnPilot Home Routers can obtain their IPv6 addresses based on how the LAN side DHCPv6 parameters are configured. The cnPilot Home Routers can be either configured as a DHCPv6 server in which the LAN/WLAN clients get IPv6 addresses from the configured pool.

If DHCP server is disabled on the cnPilot Home Routers, the clients will get Ipv6 addresses from the external DHCPv6 server configured in the network.

## LAN DHCPv6

When Ipv6 is enabled, the LAN/WLAN clients of cnPilot Home Routers can be configured to receive Ipv6 addresses from locally configured Ipv6 pool or from an external DHCPv6 server.

To enable LAN DHCPv6 service:

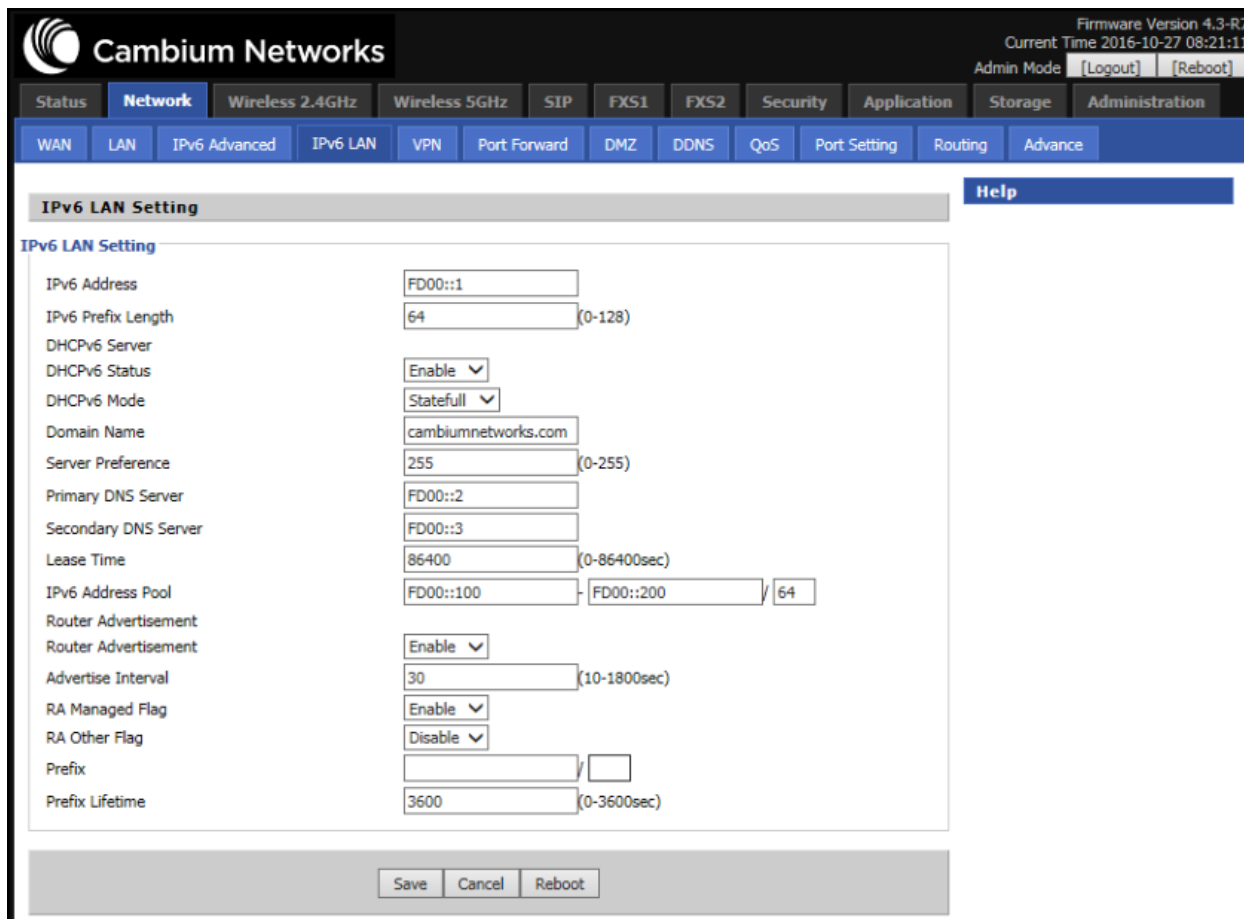

The screenshot displays the Cambium Networks web interface for configuring IPv6 LAN settings. The interface includes a navigation menu with options like Status, Network, Wireless 2.4GHz, Wireless 5GHz, SIP, FXS1, FXS2, Security, Application, Storage, and Administration. The 'Network' section is expanded to show 'IPv6 LAN' settings. The configuration page is titled 'IPv6 LAN Setting' and contains the following fields:

Field	Value	Range/Options
IPv6 Address	FD00::1	
IPv6 Prefix Length	64	(0-128)
DHCPv6 Server		
DHCPv6 Status	Enable	Enable
DHCPv6 Mode	Statefull	Statefull
Domain Name	cambiumnetworks.com	
Server Preference	255	(0-255)
Primary DNS Server	FD00::2	
Secondary DNS Server	FD00::3	
Lease Time	86400	(0-86400sec)
IPv6 Address Pool	FD00::100 - FD00::200	/ 64
Router Advertisement	Enable	Enable
Advertise Interval	30	(10-1800sec)
RA Managed Flag	Enable	Enable
RA Other Flag	Disable	Disable
Prefix		
Prefix Lifetime	3600	(0-3600sec)

At the bottom of the configuration page, there are three buttons: 'Save', 'Cancel', and 'Reboot'.

## LAN

### LAN Port

Using the LAN ports the user can plug computers and other devices that need an Internet connection.

Status	Network	Wireless 2.4GHz	Wireless 5GHz	Security	Application	Administration					
WAN	LAN	IPv6 Advanced	IPv6 LAN	VPN	Port Forward	DMZ	DDNS	QoS	Port Setting	Routing	Advance

### PC Port(LAN)

**PC Port(LAN)**

Local IP Address:

Local Subnet Mask:

Local DHCP Server:

DHCP Start Address:

DHCP End Address:

DNS Mode:

Primary DNS:

Secondary DNS:

Client Lease Time(0-86400s):

DHCP Static Allotment

NO.	MAC	IP Address
<input type="button" value="Delete Selected"/> <input type="button" value="Add"/> <input type="button" value="Edit"/>		

Add New Rule(MAX 32):

DNS Proxy:

Hardware NAT Enable:

**Help**

**PC Port(LAN):**

*NAT* - The product will be same as a router.

---

*Bridge* - The LAN port is same as the WAN port.

---

*Local DHCP Server* - It will assign the IP Addressed set here to devices that connect to the LAN port.

Table 22 : LAN port

Field Name	Description
IP Address	Enter the IP address of the router on the local area network. All the IP addresses of the computers which are in the router's LAN must be in the same network segment with this address, and the default gateway of the computers must be this IP address. (The default is 192.168.11.1).
Local Subnet Mask	Enter the subnet mask to determine the size of the network (default is 255.255.255.0/24).
Local DHCP Server	Enable/Disable Local DHCP Server.
DHCP Start Address	Enter a valid IP address as a starting IP address of the DHCP server, and if the router's LAN IP address is 192.168.11.1, starting IP address can be 192.168.11.2 or greater, but should be less than the ending IP address.
DHCP End Address	Enter a valid IP address as an end IP address of the DHCP pool.
DNS Mode	Select DNS mode, options are Auto and Manual.
Primary DNS	Enter the preferred DNS address.
Secondary DNS	Enter the secondary DNS address.

Field Name	Description
Client Lease Time	This option defines how long the address will be assigned to the computer within the network. In that period, the server does not assign the IP address to the other computer.
DNS Proxy	Enable or disable; If enabled, the device will forward the DNS request of LAN-side network to the WAN side network.
Hardware NAT Enable	Enable or disable Hardware NAT

## DHCP Server

The router has a built-in DHCP server that assigns private IP address to each local client.

DHCP stands for Dynamic Host Configuration Protocol. The router, by factory default acts a DHCP server for your network so it automatically dispatches related IP settings to any local user configured as a DHCP client. It is highly recommended that you leave the router enabled as a DHCP server if you do not have a DHCP server for your network.

**PC Port(LAN)**

**PC Port(LAN)**

Local IP Address	192.168.11.1
Local Subnet Mask	255.255.255.0
Local DHCP Server	Enable ▼
DHCP Start Address	192.168.11.2
DHCP End Address	192.168.11.254
DNS Mode	Auto ▼

Table 22 DHCP server settings

Field Name	Description
Local DHCP Server	Enable/Disable DHCP server.
DHCP Start Address	Enter a value of the IP address pool for the DHCP server to start with when issuing IP addresses.
DHCP End Address	Enter a value of the IP address pool for the DHCP server to end with when issuing IP addresses.
DNS Mode	If DNS information is to be received from a network server, set this parameter to Auto. If DNS information is to be configured manually, set this parameter to Manual.

Primary DNS	<input type="text" value="192.168.11.1"/>
Secondary DNS	<input type="text" value="8.8.8.8"/>
Client Lease Time(0-86400s)	<input type="text" value="86400"/>
<input type="button" value="DHCP Client List"/>	

Table 23 :DHCP server, DNS and Client Lease Time

Field Name	Description
Primary DNS	Specify the Primary DNS address provided by your ISP. If your ISP does not provide it, the router will automatically apply default DNS Server IP address: 202.96.134.33 to this field.
Secondary DNS	Specify the Secondary DNS address provided by your ISP. If your ISP does not provide this address, the router will automatically apply default Secondary DNS Server IP of 202.96.128.86 to this field.  If both the Primary IP and Secondary IP Address fields are left empty, the router will assign its own IP address to local users as a DNS proxy server and maintain a DNS cache.
Client Lease Time	It allows you to set the leased time for the specified PC.

## VPN

The cnPilot Home Router supports VPN connections with PPTP-based VPN servers.

The screenshot shows the 'VPN Settings' page in the router's web interface. The 'Administration' section includes the following fields:

- VPN Enable: L2TP (dropdown)
- Initial Service IP:
- User Name:
- Password:
- L2TP Tunnel Name:
- L2TP Tunnel Password:
- VPN As Default Route: Disable (dropdown)

Buttons at the bottom: Save, Cancel, Reboot.

Help text: **VPN Settings:** PPTP/L2TP - The Initial Service IP is the IP Address of a server that provides PPTP/L2TP services.

Table 24 : VPN

Field Name	Description
VPN Enable	Enable/Disable VPN. If the VPN is enabled, user can select PPTP and L2TP mode

	VPN.
Initial Service IP	Enter VPN server IP address.
Username	Enter authentication username.
Password	Enter authentication password.
L2TP Tunnel Name	Enter the name for L2TP tunnel.
L2TP Tunnel Password	Enter the password for L2TP tunnel.
VPN As Default Route	Enable/Disable the VPN as default route.

## DMZ

The screenshot shows a web interface for configuring a DMZ. The top navigation bar includes tabs for Status, Network, Wireless, SIP, FXS1, FXS2, Security, Application, and Storage. Under the Network tab, there are sub-tabs for WAN, LAN, MAC Clone, VPN, DMZ, Port Forward, Advance, Port Setting, QoS, and Routing. The DMZ tab is active, displaying the 'Demilitarized Zone (DMZ)' section. Below this, the 'DMZ Setting' section contains a 'DMZ Enable' field with a dropdown menu set to 'Disable'. At the bottom of the page, there are three buttons: 'Save', 'Cancel', and 'Reboot'.

Table 25 :DMZ

Field Name	Description
DMZ Enable	Enable/Disable DMZ.
DMZ Host IP Address	Enter the private IP address of the DMZ host.

## Port Forward

Status		Network	Wireless	SIP	FXS1	FXS2	Security	Application	Storage	Administration
WAN	LAN	MAC Clone	VPN	DMZ	Port Forward	Advance	Port Setting	QoS	Routing	
Port Forwarding										
No.	Comment	IP Address	Port Range	Protocol						
<input type="button" value="Delete Selected"/> <input type="button" value="Add"/> <input type="button" value="Edit"/>										
Port Forwarding										
Comment		<input type="text"/>								
IP Address		<input type="text"/>								
Port Range		<input type="text"/> - <input type="text"/>								
Protocol		TCP&UDP ▾								
<input type="button" value="Apply"/>		<input type="button" value="Cancel"/>								
Virtual Servers										
No.	Comment	IP Address	Public Port	Private Port	Protocol					
<input type="button" value="Delete Selected"/> <input type="button" value="Add"/> <input type="button" value="Edit"/>										
Virtual Servers										
Comment		<input type="text"/>								
IP Address		<input type="text"/>								
Public Port		<input type="text"/>								
Private Port		<input type="text"/>								
Protocol		TCP&UDP ▾								
<input type="button" value="Apply"/>		<input type="button" value="Cancel"/>								

Table 26 : Port Forward

Field Name	Description
Comment	Sets the name of a port mapping rule or comment
IP Address	The IP address of devices under the LAN port.
Port Range	Set the port range for the devices under the LAN port. (1-65535)
Protocol	You can select TCP, UDP, TCP & UDP three cases
Apply/Cancel	After finish configurations, click apply, the number will be generated under NO. List; click Cancel to if you do not want to make the changes.
Comment	To set up a virtual server notes
IP Address	Virtual server IP address
Public Port	Public port of virtual server
Private Port	Private port of virtual server.
Protocol	You can select from TCP, UDP, and TCP&UDP.



Field Name	Description
Apply/Cancel	After finish configurations, click apply, the number will be generated under NO. List; click Cancel to if you do not want to make the changes.

## DDNS Setting

**DDNS Setting**

**DDNS Setting**

Dynamic DNS Provider: None ▼

Account:

Password:

DDNS URL:

Status: DDNS updated Fail!

Table 27 :DDNS setting

Field Name	Description
Dynamic DNS Provider	DDNS is enabled and select a DDNS service provider.
Account	Enter the DDNS service account.
Password	Enter the DDNS service account password.
DDNS	Enter the DDNS domain name or IP address.
Status	See if DDNS is successfully upgraded.

## Advance

Status	Network	Wireless	SIP	FXS1	FXS2	Security	Application	Storage	
WAN	LAN	MAC Clone	VPN	DMZ	Port Forward	Advance	Port Setting	QoS	Routi
Most Nat connections(512-8192)		4096							
Mss Mode		<input type="radio"/> Manual <input checked="" type="radio"/> Auto							
Mss Value(1260-1460)		1260							
AntiDos-P		<input checked="" type="radio"/> Enable <input type="radio"/> Disable							
IP conflict detection		<input checked="" type="radio"/> Enable <input type="radio"/> Disable							
IP Conflict Detecting Interval(0-3600)		0							
<input type="button" value="Save"/> <input type="button" value="Cancel"/> <input type="button" value="Reboot"/>									

Table 28 :Advance

Field Name	Description
Most Nat connections	The largest value which the cnPilot Home Router can provide
Mss Mode	Choose Mss Mode as Manual or Auto.
Mss Value	Set the value of TCP.
AntiDos-p	You can choose to enable or disable.
IP conflict detection	You can choose to enable or disable.
IP conflict Detecting Interval	Detect IP address conflicts of the time interval.

## Port Setting

The screenshot shows the 'Port Setting' configuration page. The navigation tabs include Status, Network (selected), Wireless, SIP, FXS1, FXS2, Security, Application, and Storage. Under the Network tab, there are sub-tabs for WAN, LAN, MAC Clone, VPN, DMZ, Port Forward, Advance, Port Setting (selected), QoS, and Routing. The main content area is titled 'Port Setting' and contains the following settings:

- WANPort Speed Nego: Auto
- LAN1Port Speed Nego: Auto
- LAN2Port Speed Nego: Auto
- LAN3Port Speed Nego: Auto
- LAN4Port Speed Nego: Auto

At the bottom of the page, there are three buttons: Save, Cancel, and Reboot.

Table 29 : Port setting

Field Name	Description
WAN Port speed Nego	Auto-negotiation, options are Auto, 100M full, 100M half-duplex, 10M half and full.
LAN1-LAN4 Port Speed Nego	Auto-negotiation, options are Auto, 100M full, 100M half, 10M half and 10M full.

## QoS

The screenshot shows the 'QoS setting' configuration page. The navigation tabs include WAN, LAN, VPN, Port Forward, DMZ, QoS (selected), MAC Clone, Port Setting, Routing, and Advance. The main content area is titled 'QoS setting' and contains the following settings:

- QoS Enable: Disable
- Upstream: (0-102400)kbit/s
- Downstream: (0-102400)kbit/s

At the bottom of the page, there are four buttons: Save, Cancel, Delete Selected, and Add.

Name	Condition									Action					
	Src.IP Address	Dst.IP Address	Protocol	Src.Port Range	Dst.Port Range	Physical Port	DSCP	802.1p	VLAN ID	Remark DSCP	Remark 802.1p	Remark VLAN_ID	Priority	Drop	Rate Limit

Table 30 : QoS

Field Name	Description
QoS Enable	Enable/Disable QoS function
Upstream	Set the upstream bandwidth
Downstream	Set the downstream bandwidth
Delete Selected	Check the items you want to delete, click the Delete option
Add	Click Add to add a new rule.



**Note**

From system release 4.2 or later, the QoS bandwidth can be configured for Upstream and Downstream.

## Routing

**Static Routing Settings**

**Add a routing rule**

Destination	<input type="text" value="1.1.1.1"/>
Host/Net	<input type="text" value="Net"/> ▼
Sub Netmask	<input type="text"/>
Gateway	<input type="text"/>
Interface	<input type="text" value="LAN"/> ▼
Comment	<input type="text"/>

---

**Current Routing table in the system**

No.	Destination	Mask	Gateway	Flags	Metric	Interface	Comment

Table 31: Routing

Field Name	Description
Destination	Destination address
Host/Net	Indicates whether single host or a network is being specified. If Net, then one more option appears where user has to configure the subnet.
Gateway	Gateway IP address
Interface	Select the desired LAN/WAN interface.
Comment	Comment

## Wireless



### Note

Starting from 4.4 release, any changes in the Wireless/Radio configuration performed on the cnPilot Home Routers can be applied on the fly and does not require a reboot. However, for all other configuration sections a reboot is required to make new configuration changes effective.

## Basic

The screenshot shows the 'Basic Wireless Settings' page. The 'Radio On/Off' is set to 'Radio Off'. 'Wireless Connection Mode' is 'AP'. 'Network Mode' is '11b/g/n mixed mode'. There are three 'Multiple SSID' entries, each with a text input field, 'Hidden' checkbox, 'Isolated' checkbox, and 'Max Client' set to '16'. 'broadcast(SSID)' is 'Enable'. 'AP Isolation' is 'Disable'. 'MBSSID AP Isolation' is 'Disable'. 'BSSID' is '00:04:56:03:47:38'. 'Frequency (Channel)' is 'Auto'. 'HT Physical Mode' is 'Mixed Mode'. 'Operating Mode' is '20/40'. 'Channel BandWidth' is '20/40'. 'Guard Interval' is 'Short'. 'Reverse Direction Grant(RDG)' is 'Enable'. 'STBC' is 'Enable'. 'Aggregation MSDU(A-MSDU)' is 'Disable'. 'Auto Block ACK' is 'Enable'. 'Decline BA Request' is 'Disable'. 'HT Disallow TKIP' is 'Enable'. 'HT LDPC' is 'Disable'.

Table 32 :Basic

Field Name	Description
Radio on/off	Select "Radio off" to disable wireless. Select "Radio on" to enable wireless.
Wireless connection mode	According to the wireless client type, select one of the modes. Modes are

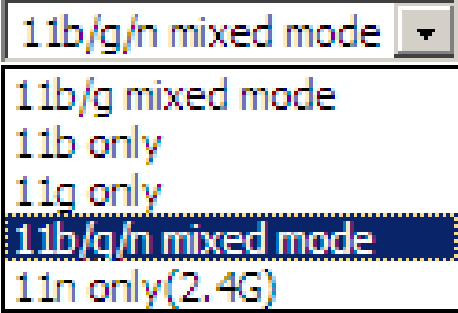
Field Name	Description
	AP/ Repeater. Default is AP.
Network Mode	<p>Choose one network mode from the drop-down list. For 5 GHz radio the default is 11vht AC/AN/A. Default is 11b/g/n mixed mode.</p> 
SSID	It is the basic identity of wireless LAN. SSID can be any alphanumeric or a combination of special characters. It will appear in the wireless network access list.
Multiple SSID1-SSID3	cnPilot r190V/r190W/r200/r200P Routers support 4 SSIDs on each radio.
Hidden	After the item is checked, the SSID is no longer displayed in the search for the Wi-Fi wireless network connection list
Broadcast (SSID)	After initial State opening, the device broadcasts the SSID of the router to wireless network
AP Isolation	If AP isolation is enabled, the clients of the AP cannot access each other.
MBSSID AP Isolation	AP isolation among the devices which does not belong to this AP. When the option is enabled, the devices which do not belong to this AP cannot access the devices which are within the AP.
BSSID	MAC address of the AP.
Frequency (Channel)	You can select Auto Select.
HT Physical Mode Operating Mode	<ol style="list-style-type: none"> <li>1. Mixed Mode: In this mode, the previous wireless card can recognize and connect to the Pre-N AP, but the throughput will be affected</li> <li>2. Green Field: high throughput can be achieved, but it will affect backward compatibility, and security of the system</li> </ol>
Channel Bandwidth	Select channel bandwidth, default is 20 MHz and 20/40 MHz. Default is 20/40
Guard Interval	Select long/short. default is short.
Reverse Direction Grant (RDG)	<p><b>Enabled:</b> Devices on the WLAN are able to transmit to each other without requiring an additional contention-based request to transfer (i.e. devices are able to transmit to another device on the network during TXOP)</p> <p><b>Disabled:</b> Devices on the WLAN must make a request for transmit when communicating with another device on the network</p>

Field Name	Description
STBC	<p>Space-time Block Code</p> <p><b>Enabled:</b> Multiple copies of signals are transmitted to increase the chance of successful delivery</p> <p><b>Disabled:</b> STBC is not employed for signal transmission</p>
Aggregation MSDU (A-MSDU)	<p><b>Enabled:</b> Allows the device to aggregate multiple Ethernet frames into a single 802.11n, thereby improving the ratio of frame data to frame overhead</p> <p><b>Disabled:</b> No frame aggregation is employed at the router</p>
Auto Block Ack	<p><b>Enabled:</b> Multiple frames are acknowledged together using a single Block Acknowledgement frame.</p> <p><b>Disabled:</b> Auto block acknowledgement is not used by the device - use this configuration when low throughput/connectivity issues are experienced by mobile devices</p>
Decline BA Request	<p><b>Enabled:</b> Disallow block acknowledgement requests from devices</p> <p><b>Disabled:</b> Allow block acknowledgement requests from devices</p>
HT Disallow TKIP	<p><b>Enabled:</b> Disallow the use of Temporal Key Integrity Protocol for connected devices</p> <p><b>Disabled:</b> Allow the use of Temporal Key Integrity Protocol for connected devices</p>
HT LDPC	<p><b>Enabled:</b> Enable Low-Density Parity Check mechanism for increasing chance of successful delivery in challenging wireless environments</p> <p><b>Disabled:</b> Disable Low-Density Parity Check mechanism</p>

## Wireless Security

Status	Network	<b>Wireless</b>	SIP	FXS1	FXS2	Security	Application	Storage	Ad
Basic	Wireless Security	WMM	WDS	WPS	Station Info	Advanced			

**WIFI Security Setting**

**Select SSID**

SSID choice CAMBIUM\_2.4GHZ\_027898 ▼  
 "CAMBIUM\_2.4GHZ\_027898"

Security Mode WPA2-PSK ▼

**WPA**

WPA Algorithms  TKIP  AES  TKIPAES

Pass Phrase \*\*\*\*\*

Key Renewal Interval 3600 sec (0 ~ 4194303)

**Access policy**

Policy Disable ▼

Add a station MAC

Table 33 : Wireless security

Field Name	Description
SSID Choice	Select the SSID for which security parameters need to be configured.
Security Mode	Select an appropriate encryption mode to improve the security and privacy of your wireless data packets. Each encryption mode will bring out different web page and ask you to offer additional configuration.

User can configure the corresponding parameters. Here are some common encryption methods:

**OPENWEP:** A handshake way of WEP encryption, encryption via the WEP key:

Table 34 : Wi-Fi Security Setting

Field Name	Description
Security Mode	This is used to select one of the 4 WEP keys, key settings on the clients should be the same with this when connecting.



Field Name	Description
WEP Keys	Set the WEP key. A-64 key need 10 Hex characters or 5 ASCII characters; choose A-128 key need 26 Hex characters or 13 ASCII characters.
WEP represents Wired Equivalent Privacy, which is a basic encryption method.	

**WPA-PSK**, the router will use WPA way which is based on the shared key-based mode:

**WIFI Security Setting**

**Select SSID**

SSID choice: CAMBIUM\_2.4GHz\_027898 ▼  
 "CAMBIUM\_2.4GHz\_027898"

Security Mode: WPA2-PSK ▼

WPA Algorithms:  TKIP  AES  TKIPAES

Pass Phrase: \*\*\*\*\*

Key Renewal Interval: 3600 sec (0 ~ 4194303)

Table 35 : WPA-PSK

Field Name	Description
WPA Algorithms	This item is used to select the encryption of wireless home gateway algorithms, options are TKIP, AES and TKIPAES.
Pass Phrase	Setting up WPA-PSK security password.
Key Renewal Interval	Set the key scheduled update cycle, default is 3600s.

**WPAPSKWPA2PSK** manner is consistent with WPA2PSK settings:

**WIFI Security Setting**

**Select SSID**

SSID choice: Wireless\_AP001118 ▼  
 "Wireless\_AP001118"

Security Mode: WPAPSKWPA2PSK ▼

WPA Algorithms:  TKIP  AES  TKIPAES

Pass Phrase: 23123123

Key Renewal Interval: 3600 Second in Month (0 ~ 4194303)

Table 36 : WPAPSKWPA2PSK

Field Name	Description
WPA Algorithms	The home gateway is used to select the wireless security encryption algorithm options are TKIP, AES, TKIP / AES. 11N mode does not support TKIP algorithms.
Pass Phrase	Set WPA-PSK/WPA2-PSK security code
Key Renewal Interval	Set the key scheduled update cycle, default is 3600s
WPA-PSK/WPA2-PSK WPA/WPA2 security type is a simplified version, which is based on the WPA shared key mode, higher security setting is also relatively simple, suitable for ordinary home users and small businesses.	

Wireless Access Policy:

Table 37 : Wireless Access Policy

Field Name	Description
Access policy	Wireless access control is used to allow or prohibit the specified client to access to your wireless network based on the MAC address.
Policy	Disable: Prohibition: wireless access control policy. Allow: only allow the clients in the list to access. Rejected: block the clients in the list to access.
Add a station MAC	Enter the MAC address of the clients which you want to allow or prohibit.
Example: Prohibit the device whose wireless network card MAC address is 00:1F: D0: 62: BA: FF's to access the wireless network and allow other computers to access the network. Implementation: As shown, the Policy is Reject, add 00:1F: D0: 62: BA: FF to the MAC, click Save and reboot the device settings to take effect.	

## WMM

The screenshot shows the 'WMM Parameters of Access Point' configuration page. The interface includes a top navigation bar with tabs for Status, Network, Wireless 2.4GHz, Wireless 5GHz (selected), SIP, FXS1, FXS2, Security, Application, Storage, and Administration. Below this is a sub-navigation bar with tabs for Basic, Wireless Security, WMM (selected), WDS, WPS, Station Info, and Advanced. The main content area features a table with the following parameters:

	Aifsn	CWMin	CWMax	Txop	ACM	AckPolicy
AC_BE	3	15	63	0	<input type="checkbox"/>	<input type="checkbox"/>
AC_BK	7	15	1023	0	<input type="checkbox"/>	<input type="checkbox"/>
AC_VI	1	7	15	94	<input type="checkbox"/>	<input type="checkbox"/>
AC_VO	1	3	7	47	<input type="checkbox"/>	<input type="checkbox"/>

At the bottom of the table are 'Apply' and 'Cancel' buttons. A 'Help' button is located to the right of the table.

Table 38 : WMM

Description
WMM (Wi-Fi Multi-Media) is the QoS certificate of Wi-Fi Alliance (WFA). This provides you to configure the parameters of wireless multimedia; WMM allows wireless communication to define a priority according to the home gateway type. To make WMM effective, the wireless clients must also support WMM.

## WDS

The screenshot shows the 'WDS Setting' configuration page. The interface includes a top navigation bar with tabs for Status, Network, Wireless (selected), SIP, FXS1, FXS2, Security, Application, and Storage. Below this is a sub-navigation bar with tabs for Basic, Wireless Security, WMM, WDS (selected), WPS, Station Info, and Advanced. The main content area features a 'WDS Config' section with a 'WDS Mode' dropdown menu set to 'Disable'. At the bottom are 'Save', 'Cancel', and 'Reboot' buttons.

The screenshot shows the 'WDS Setting' page in a network configuration interface. The page is divided into several sections:

- Navigation Tabs:** Status, Network, **Wireless**, SIP, FXS1, FXS2, Security, Application, Storage, Administration.
- Sub-Menu:** Basic, Wireless Security, WMM, **WDS**, WPS, Station Info, Advanced.
- WDS Setting:** A section with a 'Help' button.
- WDS Config:** A table of settings:
 

WDS Mode	Lazy Mode
Phy Mode	CCK
EncrypType	NONE
Encryp Key	
EncrypType	NONE
Encryp Key	
EncrypType	NONE
Encryp Key	
EncrypType	NONE
Encryp Key	
- Buttons:** Save, Cancel, Reboot.

Table 39 : WDS

Description
WDS stands for Wireless Distribution System, enabling WDS access points to be interconnected to expand a wireless network.

## WPS

WPS (Wi-Fi Protected Setup) provides easy procedure to make network connection between wireless station and wireless access point with the encryption of WPA and WPA2.



### Note

WPS is disabled by default. To enable WPS, under WPS Setting, select Enable from the drop-down and click Apply.

It is the simplest way to build connection between wireless network clients and wireless access point. Users do not need to select any encryption mode and type any long encryption passphrase to setup a wireless client every time. The only requirement is for the user to press the WPS button on the wireless client, and WPS will connect for client and router automatically.

Perform the below steps on cnPilot for WPS (it is applicable only for cnPilot r195W Home Router):

1. Tap **WPS** button on the phone.
2. Press WPS button on cnPilot r195W/r195P Home Router (press-and-release).
  - if you press WPS button only once (press and release), then the client connects to 2.4G radio
  - if you press WPS button twice within 2 seconds, then the client connects to 5GHz
  - if you press and hold WPS button for more than 2 seconds, then no action happens.

Status	Network	<b>Wireless</b>	SIP	FXS1	FXS2	Security	Application	Storage
Basic	Wireless Security	WMM	WDS	WPS	Station Info	Advanced		

### WPS Setting

**WPS Config**

WPS  ▼

---

**WPS Summary**

WPS Current Status	Idle
WPS Configured	Yes
WPS SSID	CAMBIUM_2.4GHz_027898
WPS Auth Mode	WPA2-PSK
WPS Encryp Type	AES
WPS Default Key Index	2
WPS Key(ASCII)	12345678
AP PIN	01619447 <input type="button" value="Generate"/>

---

**WPS Progress**

WPS Mode  PIN  PBC

PIN

---

**WPS Status**

WSC:Idle

Table 40 : WPS

Field Name	Description
WPS Setting	Enable/Disable WPS function
WPS Summary	Display the current status of WPS, including current state, SSSID name, authentication methods, encryption type and the PIN code of this AP.
Generate	Generate a new PIN code
Reset OOB	<ul style="list-style-type: none"> <li>cnPilot Wi-Fi r190V/r190W/r200/r200P Routers use a default security policy to allow other non-WPS users to access and apply.</li> </ul>

Field Name	Description
WPS Mode	<ul style="list-style-type: none"> <li>• <b>PIN:</b> Enter the PIN code of the wireless device which accesses to this LAN in the following option, and press apply. Then cnPilot Home Router r190V/r190W/r200/r200P begins to send signals, turn on the PIN accessing method on the clients, and then it can access the wireless AP automatically.</li> <li>• <b>PBC:</b> There are two ways to start PBC mode, user can press the PBC button directly on the device or select PBC mode on the software and apply. Users can activate WPS connection in WPS mode through these two methods, only when the clients choose PBC access, the clients can connect the AP automatically.</li> </ul>
WPS Status	<p>WPS shows status in three ways:</p> <ul style="list-style-type: none"> <li>• WSC: Idle</li> <li>• WSC: Start WSC process (begin to send messages)</li> <li>• WSC : Success; this means clients have accessed the AP successfully</li> </ul>

## Station Info

Status	Network	Wireless	SIP	FXS1	FXS2	Security	Application	Storage	Adn
Basic	Wireless Security	WMM	WDS	WPS	Station Info	Advanced			
<b>Wireless Status</b>									
<b>Wireless Status</b>									
Current Channel		Channel 1							
CAMBIUM_2.4GHz_027898		00:04:56:02:78:98							
<b>Wireless Network</b>									
<b>Wireless Network</b>									
MAC Address	Aid	PSM	MimoPS	MCS	BW	SIG	STBC		
20:54:76:96:9B:1A	1	0	3	7	20M	0	1		

Table 41: Station info

Description
This page displays information about the current registered clients' connections including operating MAC address and operating statistics.

## Advanced

**Advanced Wireless**

**Advanced Wireless**

BG Protection Mode	Auto ▾
Beacon Interval	100 ms (range 20 - 999, default 100)
Data Beacon Rate (DTIM)	3 (range 1 - 255, default 3)
Fragment Threshold	2346 (range 256 - 2346, default 2346)
RTS Threshold	2347 (range 1 - 2347, default 2347)
TX Power	12.5% ▾ (5dBm)
Short Preamble	<input checked="" type="radio"/> Enable <input type="radio"/> Disable
Short Slot	<input checked="" type="radio"/> Enable <input type="radio"/> Disable
Tx Burst	<input checked="" type="radio"/> Enable <input type="radio"/> Disable
Pkt_Aggregate	<input checked="" type="radio"/> Enable <input type="radio"/> Disable
Country Code	JP (Japan) ▾

**Wi-Fi Multimedia**

WMM Capable	
Multiple SSID	<input checked="" type="checkbox"/>
Multiple SSID1	<input type="checkbox"/>
Multiple SSID2	<input type="checkbox"/>
Multiple SSID3	<input type="checkbox"/>
APSD Capable	<input type="radio"/> Enable <input checked="" type="radio"/> Disable
DLS Capable	<input type="radio"/> Enable <input checked="" type="radio"/> Disable
Multicast-to-Unicast Converter	
Multicast-to-Unicast	<input type="radio"/> Enable <input checked="" type="radio"/> Disable

Table 42: Advanced

Field Name	Description
BG Protection Mode	Select G protection mode, options are on, off and automatic.
Beacon Interval	The interval of sending a wireless beacon frame, within this range, it will send a beacon frame for the information of the surrounding radio network.
Data Beacon Rate (DTIM)	Specify the interval of transmitting the indication message, it is a kind of cut down operation, and it is used for informing the next client which is going to receive broadcast multi-cast.
Fragment Threshold	Specify the fragment threshold for the packet, when the length of the packet exceeds this value, the packet is divided.
RTS Threshold	Specify the packet RTS threshold, when the packet exceeds this value, the router will send RTS to the destination site consultation

Field Name	Description
TX Power	Define the transmission power of the current AP, the greater it is, the stronger the signal is.
Short Preamble	Default is Enable, cnPilot r190V/r190W/r200/r200P Routers system is not compatible with traditional IEEE802.11, the operation rate can be 1.2Mbps.
Short Slot	Enable/Disable short slot. By default, it is enabled. It is helpful in improving the transmission rate of wireless communication.
Tx Burst	One of the features of MAC layer, it is used to improve the fairness for transmitting TCP.
Pkt_Aggregate	It is a mechanism that is used to enhance the LAN, in order to ensure that the home gateway packets are sent to the destination correctly.
IEEE802.11H support	Enable/Disable IEEE802.11H Support. By default, it is disabled.
Country Code	Select country code, options are CN, US, JP, FR, TW, IE, HK and NONE.
<b>Wi-Fi Multimedia (WMM)</b>	
WMM Capable	Enable/Disable WMM.
APSD Capable	Enable/Disable APSD. Once it is enabled, it may affect wireless performance, but can play a role in energy-saving power.
WMM Parameters	Press <a href="#">WMM Configuration</a> , the webpage will jump to the configuration page of Wi-Fi multimedia.
Multicast-to-Unicast Converter	Enable/Disable Multicast-to-Unicast. By default, it is Disabled.

## WDS

See WDS.

## WPS

See WPS.

## Station Info

See Station Info.

## Advanced

See Advanced.

## Parental Control

Router Limits is a Parental Control and Screen time management service. Subscribers of Router Limits can enable this service on cnPilot Home Router devices. This feature has the ability to enforce policy restrictions even for devices off the home network. This feature enables Cambium cnPilot-R to provide









Parental Control services. It has the ability to perform Network activity monitoring. It can perform CAF II complaint Speed testing.

Table 43 :Features and Services

Category	Features
Device Management	Auto Discovery Online Status Connection Info Grouping by Function
Parental Controls	Internet Pause Content Filtering –Parental Control Time Scheduling Browsing History Mobile Protection* (off network)
Network Activity Monitoring	Real Time Data Usage by Device* Data Usage by Service* Historical Bandwidth*
Speed Test	On Demand Speed Testing Historical Results* Scheduled*

	filter by categories & popular sites
	lock google & bing in safe search mode
	enforce youtube restricted mode
	track browsing history
	limit screen time
	customize settings by device
	protect wifi & mobile data*

## How to Configure

To configure Router-Limits, perform the following steps:

### Step 1: (Device UI)

Status	Network	Wireless 2.4GHz	Wireless 5GHz	SIP	FXS1	FXS2	Security	Application
Filtering Setting   Content Filtering   Router Limits								
<b>Router Limits Settings</b>								
<b>Router Limits Settings</b>								
Current Status	not running							
Current Version	2.14.5-release-mipsel32-generic-20190429151033							
Router Limits	Disable ▼							
Pairing Code	233157665253041							
<input type="button" value="Save"/> <input type="button" value="Reboot"/>								

## Step 2: (Device UI)

The screenshot shows the 'Router Limits Settings' page in a web interface. At the top, there are navigation tabs: Status, Network, Wireless 2.4GHz, Wireless 5GHz, SIP, FXS1, FXS2, Security (selected), and Application. Below these are sub-tabs: Filtering Setting, Content Filtering, and Router Limits (selected). The main content area is titled 'Router Limits Settings' and contains the following information:

Current Status	ready
Current Version	2.14.5-release-mipsel32-generic-20190429151033
Router Limits	Enable ▼
Pairing Code	233157665253041 <a href="#">Activate</a>

At the bottom of the page, there are two buttons: 'Save' and 'Reboot'.

## Step 3: (routerlimits.com)

The screenshot shows the 'Settings' page of the Router Limits web application. On the left is a sidebar menu with the following items: Dashboard, Devices, Limits, History, Bandwidth, Speed Test, Settings (selected), and Support. The main content area is titled 'Settings' and includes a link to 'Learn more about Settings.' The page is divided into several sections:

- Router Information:** Status: OFFLINE, Pairing Code: 752810158803316, Client Version: 2.14.5. A 'PAIR HARDWARE' button is located at the bottom right of this section.
- Locale:** Timezone: America/Denver. A 'SAVE' button is located at the bottom right of this section.
- Mobile App Protection:** Shows 0 devices connected via mobile app. Below this, there is a message: 'Using the Router Limits mobile companion apps for iOS and Android, every connection is protected. You can manage your devices even when they are connected to LTE data, or someone else's WIFI network, the same as if they were home.' At the bottom of this section are two buttons: 'Available on the App Store' and 'Get it on Google play'.

At the bottom left of the sidebar, there is a 'Collapse' button with a left-pointing arrow.

#### Step 4: (routerlimits.com)

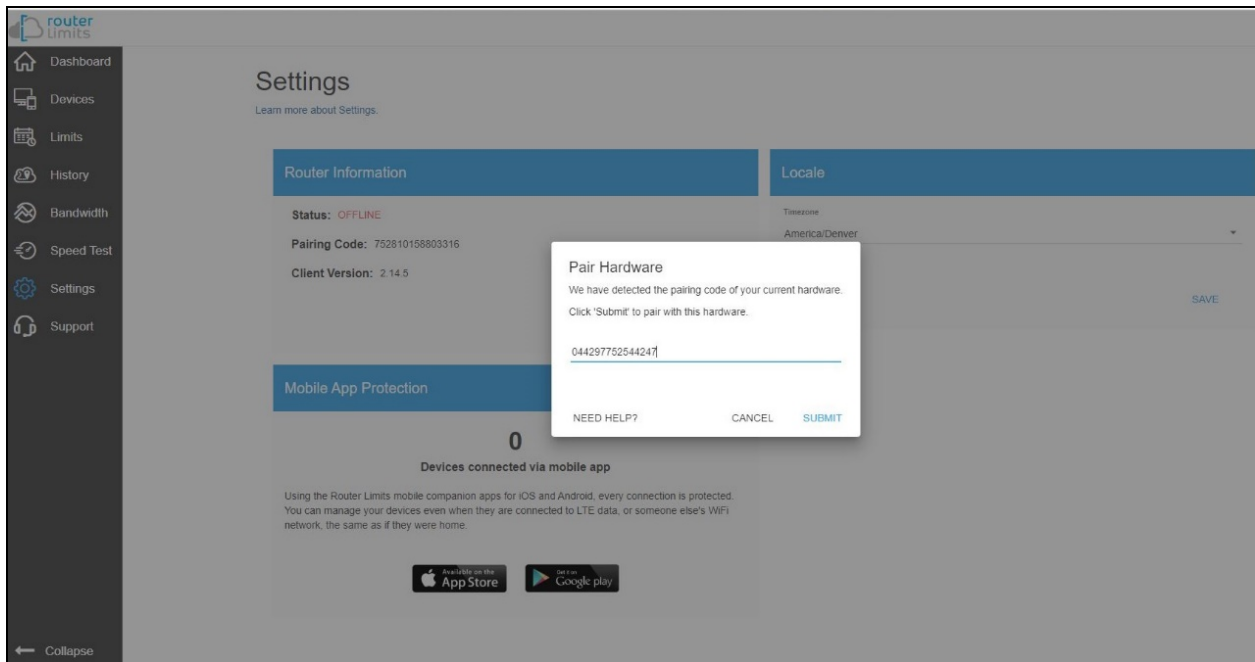

#### Step 5: (routerlimits.com)

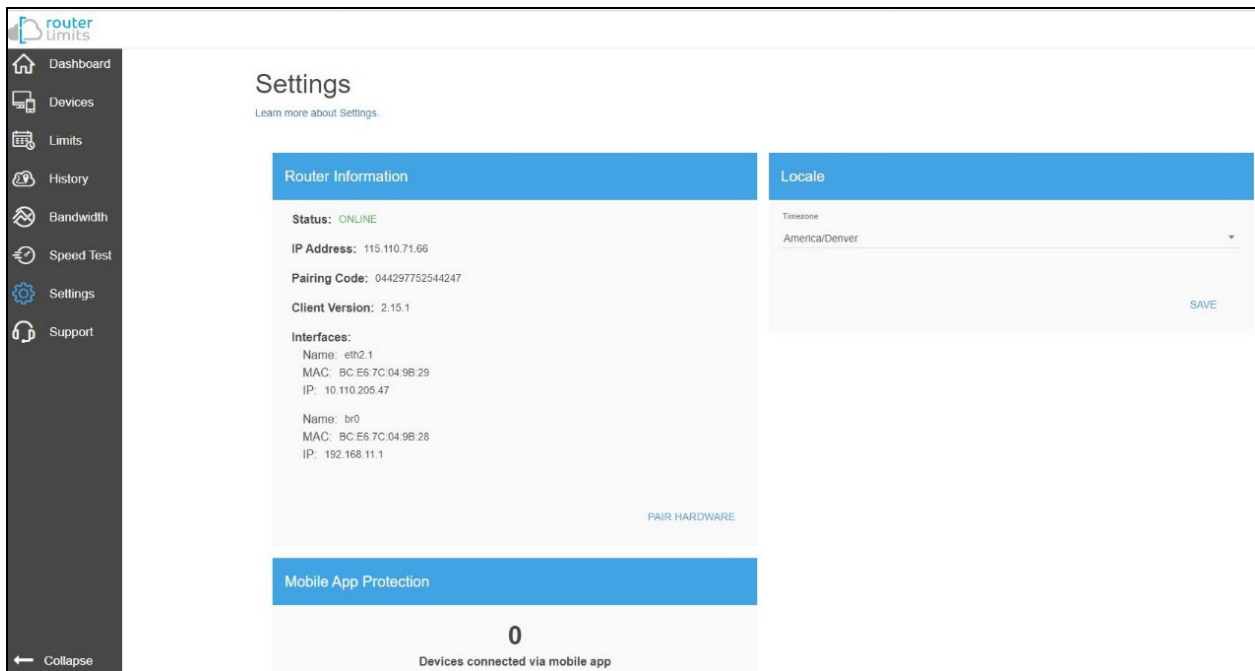

## Step 6: (Device UI)

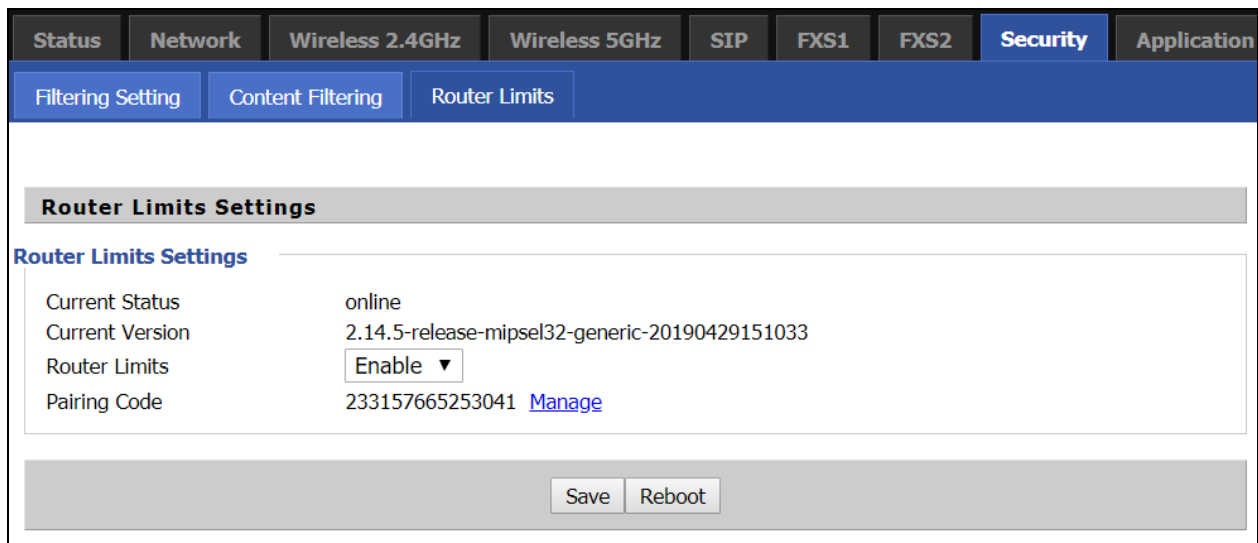

The screenshot shows the 'Router Limits Settings' page in the device UI. The page has a navigation bar with tabs for 'Status', 'Network', 'Wireless 2.4GHz', 'Wireless 5GHz', 'SIP', 'FXS1', 'FXS2', 'Security', and 'Application'. Under the 'Security' tab, there are sub-tabs for 'Filtering Setting', 'Content Filtering', and 'Router Limits'. The 'Router Limits Settings' section displays the following information:

Current Status	online
Current Version	2.14.5-release-mipsel32-generic-20190429151033
Router Limits	Enable ▼
Pairing Code	233157665253041 <a href="#">Manage</a>

At the bottom of the page, there are 'Save' and 'Reboot' buttons.

## Manual Configuration

Under some situations automatic pairing of the cnPilot-R series device may not happen. Such cases user can manually pair the device to Router Limits by clicking on the “Activate” Button on the cnPilot R-series GUI and by entering the Pairing code on the following link manually.

See the following example:

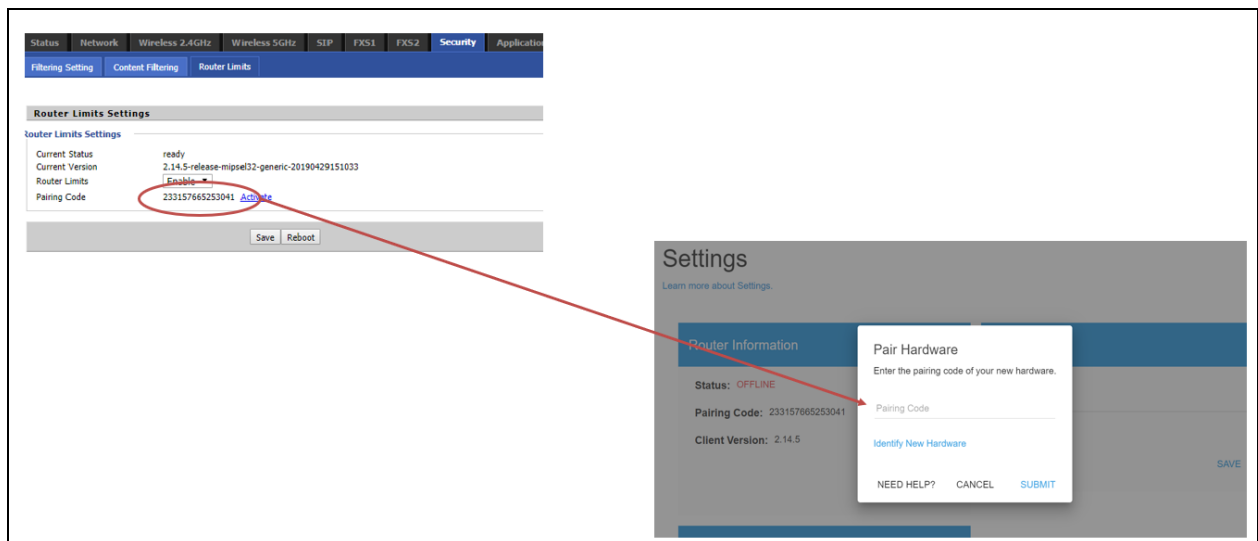

The screenshot illustrates the manual configuration process. On the left, the 'Router Limits Settings' page is shown with the 'Pairing Code' field circled in red. A red arrow points from this field to a 'Pair Hardware' dialog box on the right. The dialog box contains the following text:

**Pair Hardware**  
Enter the pairing code of your new hardware.

Pairing Code: \_\_\_\_\_

[Identify New Hardware](#)

NEED HELP? CANCEL SUBMIT

The background shows the 'Router Information' section of the settings page, which displays: Status: OFFLINE, Pairing Code: 233157665253041, and Client Version: 2.14.5.

## SIP

cnPilot Home Routers have 2 FXS ports to make SIP (Session Initiation Protocol) calls for the supported models. Before registering, the device user should have a SIP account configured by the system administrator or provider. See the section below for more information.

# SIP Settings

**Cambium Networks** Firmware Version 4.7.2-R6  
Current Time 2020-10-01 15:05:58  
Admin Mode [Logout] [Reboot]

Status Network Wireless 2.4GHz Wireless 5GHz **SIP** FXS1 FXS2 Security Application Storage Administration

SIP Settings VoIP QoS Dial Rule Blacklist Call Log

**SIP Parameters**

**SIP Parameters**

SIP T1: 500 ms  
 SIP User Agent Name:   
 Reg Retry Intvl: 30 sec  
 Mark All AVT Packets: Enable  
 SRTP: Disable  
 Service Type: Common  
 Transport: UDP  
 IPv4/IPv6: IPv4

Max Forward: 70  
 Max Auth: 2  
 Reg Retry Long Intvl: 1200 sec  
 RFC 2543 Call Hold: Enable  
 SRTP Prefer Encryption: AES\_CM  
 DNS Refresh Timer: 0 sec

**Response Status Code Handling**

Retry Reg RSC:

**NAT Traversal**

NAT Traversal: Disable  
 NAT Refresh Interval(sec): 60  
 STUN Server Address:   
 STUN Server Port: 3478

Save Cancel Reboot

**Help**

**SIP Parameters :**  
These parameters are related to registration and call.

**NAT Traversal:**  
It is helpful for the device behind NAT.

Table 44 :SIP settings

Field Name	Description
SIP T1	The minimum scale of retransmission time
Max Forward	SIP contains Max Forward message header fields used to limit the requests for forwards.
SIP Reg User Agent Name	The agent name of SIP registered user
Max Auth	The maximum number of retransmissions
Mark All AVT Packets	Voice packet marking to enable this item will see the mark on the voice message when the call environment changed (such as press a key during the call)
RFC 2543 Call Hold	Enable the Connection Information field displays the address is 0.0.0.0 in the invite message of Hold. Disable the Connection Information field displays the device IP address in the invite message of Hold.
SRTP	Whether to enable the call packet encryption function

Field Name	Description
SRTP Prefer Encryption	The preferred encryption type of calling packet (the Message body of INVITE Message)
Service Type	Choose the service type.
NAT Traversal	Enable/Disable NAT Traversal cnPilot Home Router supports STUN Traversal; if user wants to traverse NAT/Firewall, select the STUN.
STUN Server Address	Add the correct STUN service provider IP address.
NAT Refresh Interval	Set NAT Refresh Interval, default is 60s.
STUN Server Port	Set STUN Server Port, default is 5060.

# Dial Rule

## Parameters and Settings

**dial rule** **Help**

**General**

dial rule Disable ▾  
 Unmatched Policy Accept ▾

No.	FXS	Digit Map	Action	Move Up	Move Down	<input type="checkbox"/>
<span>Edit</span> <span>Add</span> <span>Delete</span>						
<span>Save</span> <span>Cancel</span> <span>Reboot</span>						

**dial rule:**  
 Controls how calls will be dialed on this line. It can add Prefix to Matched Number and remove Digits by setting Dial Cuts.

- '0 1 2 3 4 5 6 7 8 9 \* #' : Legal characters.
- 'x' : Lowercase letter x stands for one legal character.
- '[sequence]': To match one character form sequence. For example:[0-9]: match one digit form 0 to 9;[23-5\*]: match one character from 2 or 3 or 4 or 5 or \*.
- 'x.': Match to x, xx, xxx, xxxx, ... ; For example?01.'can match'0?01?011?011111?.
- '<dialled>:substituted>': Replace dialled with substituted. For example?<#:23%>xx<#:23%>', input is '#56#', output is '23%5623%'.
- 'x,y': Make outside dial tone after dialing 'x', stop until dialing character 'y'. For example: '<5,:><:241333>8101', input is '58101', output is '2413338101'. Besides telephone input 5 will have a dial tone, dial 8 after stopping at.
- 'T' : Set delay time. In 2 seconds after the phone will set aside a valid number.

Table 45: Parameters and settings

Field Name	Description
Dial Plan	Enable/Disable dial plan.
Line	Set the line.
Digit Map	Enter the sequence used to match input number The syntactic - refer the following Dial Plan Syntactic
Action	Choose the dial plan mode from Deny and Dial Out. Deny means cnPilot Home Routers will reject the matched number, while Dial Out means cnPilot Home Routers will dial out the matched number.

Field Name	Description
Move Up	Move the dial plan up the list
Move Down	Move the dial plan down the list

## Adding one Dial Plan

**Dial Plan**

**General**

Dial Plan Disable ▼

Unmatched Policy ▼

No.	FXS	Digit Map	Action	Move Up	Move Down		
	FXS <span style="border: 1px solid #ccc; padding: 2px;">FXS 1 ▼</span>	Digit Map <span style="border: 1px solid #ccc; display: inline-block; width: 100px; height: 15px;"></span>	Action <span style="border: 1px solid #ccc; padding: 2px;">Deny ▼</span>				<span style="border: 1px solid #ccc; padding: 2px 5px;">OK</span> <span style="border: 1px solid #ccc; padding: 2px 5px; margin-left: 5px;">Cancel</span>

1. Enable **Dial Plan**.
2. Click **Add**, and the configuration table.
3. Fill in the value of parameters.
4. Press **OK** to end configuration.

## Dial Plan Syntactic

Table 46 : Dial Plan

No.	String	Description
1	0 1 2 3 4 5 6 7 8 9 * #	Allowed characters
2	x	Lowercase letter x stands for one legal character
3	[sequence]	To match one-character form sequence. For example: [0-9]: match one digit from 0 to 9 [23-5*]: match one character from 2 or 3 or 4 or 5 or *
4	x.	Match to $x^0, x^1, x^2, x^3, \dots, x^n$ For example: "01.":can match "0", "01", "011", "0111", ....., "01111..."



No.	String	Description
5	<dialled:substituted>	Replace dialled with substituted. For example: <8:1650>123456: input is "85551212", output is "16505551212"
6	x,y	Make outside dial tone after dialing "x", stop until dialing character "y" For example: "9,1xxxxxxxxx": the device reports dial tone after inputting "9", stops tone until inputting "1" "9,8,010x": make outside dial tone after inputting "9", stop tone until inputting "0"
7	T	Set the delayed time. For example: "<9:111>T2": The device will dial out the matched number "111" after 2 seconds.

## Blacklist

In this page, user can upload or download blacklist file, and can add or delete or edit blacklist one by one.

[Status](#)
[Network](#)
[Wireless 2.4GHz](#)
[Wireless 5GHz](#)
[SIP](#)
[FXS1](#)
[FXS2](#)
[Security](#)
[Application](#)
[Storage](#)
[Administration](#)

[SIP Settings](#)
[VoIP QoS](#)
[Dial Rule](#)
[Blacklist](#)
[Call Log](#)

### Blacklist Upload && Download

Blacklist Upload && Download

Local File  No file chosen

---

### Blacklist

Index	Name	Number	<input type="checkbox"/>

#### Help

**Phonebook:**  
The list Shows all the directory entries. Please click "Save Settings" button to save this list after you edit or add an item.

---

**Blacklist:**  
Calls from this list can not get through.

### Blacklist Upload && Download

Blacklist Upload && Download

Local File  No file chosen

Blacklist			
Index	Name	Number	<input type="checkbox"/>
1	Rob	12345	<input type="checkbox"/>
2	Henry	123456	<input type="checkbox"/>

1. Click  to select the blacklist file and click  to upload it to cnPilot Home Router. Click  to save the blacklist file to your local computer.
2. Select one contact and click edit to change the information, click **Delete** to delete the contact, click **Move** to phonebook to move the contact to phonebook.
3. Click **Add** to add one blacklist, enter the name and phone number, click **OK** to confirm and click **Cancel** to cancel.

Name	<input type="text" value="Ded"/>
Number	<input type="text" value="123589"/>
<input type="button" value="OK"/> <input type="button" value="Cancel"/>	

## Call Log

To view the call log information such as redial list (incoming call), answered call and missed call.

Table 47 : Call log

Redial List				
Index	NUMBER	Start Time	Duration	<input type="checkbox"/>
1	123	10/28 10:30	00:00:07	<input type="checkbox"/>
2	010123	10/28 12:02	00:00:01	<input type="checkbox"/>
3	010123	10/28 16:16	00:00:00	<input type="checkbox"/>
4	010123	10/28 16:16	00:00:00	<input type="checkbox"/>
5	123	10/28 16:20	00:00:13	<input type="checkbox"/>
6	123	10/28 16:21	00:00:34	<input type="checkbox"/>
7	123	10/29 10:50	00:00:10	<input type="checkbox"/>
8	123	10/29 14:36	00:00:01	<input type="checkbox"/>
9	123	10/29 15:05	00:00:23	<input type="checkbox"/>
10	123	10/29 15:06	00:00:05	<input type="checkbox"/>
..	...	...	...	<input type="checkbox"/>

Redial List

Answered Calls				
Index	NUMBER	Start Time	Duration	<input type="checkbox"/>
1	22222	10/21 09:56	00:00:40	<input type="checkbox"/>
2	110	10/21 18:14	00:00:03	<input type="checkbox"/>
3	110	10/21 18:15	00:00:07	<input type="checkbox"/>
4	sipp	10/23 13:40	00:00:06	<input type="checkbox"/>
5	sipp	10/24 18:05	00:00:05	<input type="checkbox"/>
6	sipp	10/24 18:05	00:00:05	<input type="checkbox"/>
7	sipp	10/25 15:38	00:00:03	<input type="checkbox"/>
8	sipp	10/25 15:42	00:00:06	<input type="checkbox"/>
9	sipp	10/25 15:55	00:00:10	<input type="checkbox"/>
10	sipp	10/25 16:03	00:00:02	<input type="checkbox"/>
..	..	..	..	<input type="checkbox"/>

Answered Calls

Missed Calls				
Index	NUMBER	Start Time	Duration	<input type="checkbox"/>
1	110	10/21 09:50	00:00:03	<input type="checkbox"/>
2	555	10/22 12:04	00:00:03	<input type="checkbox"/>

Missed Calls

## VoIP QoS

Status	Network	Wireless	SIP	FXS1	FXS2	Security	Application	Storage
SIP Settings		VoIP QoS						
<b>QoS Settings</b>								
Layer 3 QoS								
SIP QoS(0-63)		<input type="text" value="46"/>						
RTP QoS(0-63)		<input type="text" value="46"/>						
<input type="button" value="Save"/> <input type="button" value="Cancel"/> <input type="button" value="Reboot"/>								

Table 48 :VoIP QoS

Field Name	Description
SIP /RTP QoS	The default value is 0, you can set a range of values is 0-63

## FXS1

### SIP Account

#### Basic

Set the basic information provided by your VOIP Service Provider, such as Phone Number, Account, password, SIP Proxy and others.



#### Warning

3-wire connection is not supported.

Basic			
<b>Basic Setup</b>			
Line Enable	Enable ▼	Outgoing Call without Registration	Disable ▼
<b>Proxy and Registration</b>			
Proxy Server	10.110.32.54	Proxy Port	5060
Outbound Server		Outbound Port	5060
Backup Outbound Server		Backup Outbound Port	5060
<b>Subscriber Information</b>			
Display Name	1000	Phone Number	1000
Account	1000	Password	*****
Audio Configuration			

Table 49 :SIP Account – Basic

Field Name	Description
Line Enable	Enable/Disable the line.
Peer To Peer	Enable/Disable PEER to PEER. If enabled, SIP-1 will not send register request to SIP server; but in Status/ SIP Account Status webpage, Status is Registered; lines 1 can dial out, but the external line number cannot dial line1.
Proxy Server	The IP address or the domain of SIP Server
Outbound Server	The IP address or the domain of Outbound Server
Backup Outbound Server	The IP address or the domain of Backup Outbound Server
Proxy port	SIP Service port, default is 5060
Outbound Port	Outbound Proxy's Service port, default is 5060
Backup Outbound Port	Backup Outbound Proxy's Service port, default is 5060
Display Name	The number will be displayed on LCD
Phone Number	Enter telephone number provided by SIP Proxy
Account	Enter SIP account provided by SIP Proxy
Password	Enter SIP password provided by SIP Proxy

## Audio Configuration

Table 50 :Audio configuration

Audio Configuration			
<b>Codec Setup</b>			
Audio Codec Type 1	G.723 ▼	Audio Codec Type 2	G.711U ▼
Audio Codec Type 3	G.711A	Audio Codec Type 4	G.722 ▼
Audio Codec Type 5	G.711U	Audio Codec Type 6	OPUS ▼
	G.722		
	G.729		
G.723 Coding Speed	G.723	Packet Cycle(ms)	20 ▼
Silence Supp	OPUS	Echo Cancel	Enable ▼
Auto Gain Control	Disable ▼	Use First Matching Vocoder in 2000K SDP	Disable ▼
Codec Priority	Remote ▼	Packet Cycle Follows Remote SDP	Disable ▼
<b>FAX Configuration</b>			
FAX Mode	T.38 ▼	ByPass Attribute Value	fax/modem ▼
T.38 CNG Detect Enable	Disable ▼	T.38 CED Detect Enable	Enable ▼
gpmid attribute Enable	Disable ▼	T.38 Redundancy	Disable ▼
Max Fax Rate	14400 ▼		
<b>Supplementary Service Subscription</b>			
<b>Supplementary Services</b>			
Call Waiting	Enable ▼	Hot Line	
MWI Enable	Enable ▼	Voice Mailbox Numbers	
MWI Subscribe Enable	Disable ▼	VMWI Serv	Enable ▼
DND	Disable ▼		
<b>Speed Dial</b>			
Speed Dial 2		Speed Dial 3	

Field Name	Description
Audio Codec Type1	Choose the audio codec type from G.711U, G.711A, G.722, G.729, G.723, OPUS
Audio Codec Type2	Choose the audio codec type from G.711U, G.711A, G.722, G.729, G.723, OPUS
Audio Codec Type3	Choose the audio codec type from G.711U, G.711A, G.722, G.729, G.723, OPUS
Audio Codec Type4	Choose the audio codec type from G.711U, G.711A, G.722, G.729, G.723, OPUS
Audio Codec Type5	Choose the audio codec type from G.711U, G.711A, G.722, G.729, G.723, OPUS

Field Name	Description
G.723 Coding Speed	Choose the speed of G.723 from 5.3kbps and 6.3kbps
Packet Cycle	The RTP packet cycle time, default is 20ms
Silence Support	Enable/Disable silence support.
Echo Cancel	Enable/Disable echo cancel. By default, it is enabled.
Auto Gain Control	Enable/Disable auto gain.
T.38 Enable	Enable/Disable T.38
T.38 Redundancy	Enable/Disable T.38 Redundancy
T.38 CNG Detect Enable	Enable/Disable T.38 CNG Detect
gpmid attribute Enable	Enable/Disable gpmid attribute.

## Supplementary Service Subscription

**Supplementary Service Subscription**

**Supplementary Services**

Call Waiting	<input type="button" value="Enable"/> ▾	Hot Line	<input type="text"/>
MWI Enable	<input type="button" value="Enable"/> ▾	Voice Mailbox Numbers	<input type="text"/>
MWI Subscribe Enable	<input type="button" value="Disable"/> ▾	VMWI Serv	<input type="button" value="Enable"/> ▾
DND	<input type="button" value="Disable"/> ▾		

**Speed Dial**

Speed Dial 2	<input type="text"/>	Speed Dial 3	<input type="text"/>
Speed Dial 4	<input type="text"/>	Speed Dial 5	<input type="text"/>
Speed Dial 6	<input type="text"/>	Speed Dial 7	<input type="text"/>
Speed Dial 8	<input type="text"/>	Speed Dial 9	<input type="text"/>

Table 51 :Supplementary service

Field Name	Description
Call Waiting	Enable/Disable Call Waiting
Hot Line	Fill in the hotline number. Pickup handset or press hands-free or headset button, the device will dial out the hotline number automatically.
MWI Enable	Enable/Disable MWI (indicates message waiting). If the user needs to user voice mail, please enable this feature.



Field Name	Description
MWI Subscribe Enable	Enable/Disable MWI Subscribe
Voice Mailbox Numbers	Fill in the voice mailbox phone number, Asterisk platform, for example, its default voice mail is *97
VMWI Serv	Enable/Disable VMWI service.
DND	Enable/Disable DND (do not disturb).  If enable, any phone call cannot arrive at the device; default is disable.
Speed Dial	Enter the speed dial phone numbers.  Dial *74 to active speed dial function.  Then press the speed dial numbers, for example, press 2, phone dials 075526099365 directly.

## Advanced

Advanced	
<b>Advanced Setup</b>	
Domain Name Type	Enable ▾
Signal Port	5060
RFC2833 Payload(>=96)	101
RTP Port	0 (=0 auto select)
Session Refresh Time(sec)	0
Prack Enable	Disable ▾
Primary SER Detect Interval	0
Keep-alive Interval(10-60s)	15
Anonymous Call Block	Disable ▾
Use OB Proxy In Dialog	Disable ▾
Dial Prefix	
Hold Method	ReINVITE ▾
Only Recv Request From Server	Enable ▾
SIP Received Detection	Disable ▾
Country Code	
Caller ID Header	FROM ▾
Carry Port Information	Disable ▾
DTMF Type	RFC2833 ▾
Register Refresh Interval(sec)	3600
Cancel Message Enable	Disable ▾
Refresher	UAC ▾
SIP OPTIONS Enable	Disable ▾
Max Detect Fail Count	3
Anonymous Call	Disable ▾
Proxy DNS Type	A Type ▾
Reg Subscribe Enable	Disable ▾
User Type	IP ▾
Request-URI User Check	Disable ▾
Server Address	
VPN	Disable ▾
Remove Country Code	Disable ▾

Table 52 :Advanced

Field Name	Description
Domain Name Type	If or not use domain name in the SIP URI.
Carry Port Information	If or not carry port information in the SIP URI.
Signal Port	The local port of SIP protocol, default is 5060.
DTMF Type	Choose the DTMF type from Inbound, RFC2833 and SIP INFO.
RFC2833 Payload (>=96)	User can use the default setting.
Register Refresh Interval	The interval between two normal Register messages. You can use the default setting.
RTP Port	Set the port to send RTP.  The device will select one idle port for RTP if you set "0"; otherwise use the value which user sets.
Cancel Message Enable	When you set enable, an unregistered message will be sent before registration, while you set disable, unregistered message will not be sent before registration. You should set the option for different Proxy.
Session Refresh Time(sec)	Time interval between two sessions, you can use the default settings.
Refresher	Choose refresher from UAC and UAS.
Prack Enable	Enable/Disable prack.
SIP OPTIONS Enable	When you set enable, the device will send SIP-OPTION to the server, instead of sending periodic Hello message. The sending interval is Keep-alive interval.
Primary SER Detect Interval	Test interval of the primary server, the default value is 0, it represents disable.
Max Detect Fail Count	Interval of detection of the primary server fail; the default value is 3, it means that if detect 3 times fail; the device will no longer detect the primary server.
Keep-alive Interval(10-60s)	The interval that the device will send an empty packet to proxy.
Anonymous Call	Enable/Disable anonymous call.
Anonymous Call Block	Enable/Disable anonymous call block.
Proxy DNS Type	Set the DNS server type, choose from A type and DNS SRV.
Use OB Proxy In Dialog	If or not use OB Proxy In Dialog.
Reg Subscribe Enable	If enable, subscribing will be sent after registration message, if not enable, do not send subscription.
Dial Prefix	The number will be added before your telephone number when making calls.

Field Name	Description
User Type	Choose the User Type from IP and Phone.
Hold Method	Choose the Hold Method from ReINVITE and INFO.
Request-URI User Check	Enable/Disable the user request URI check.
Only Recv request from server	Enable/Disable the only receive request from server.
Server Address	The IP address of SIP server.
SIP Received Detection	Enable/Disable SIP Received Detection, if enable, use it to confirm the public network address of the device.

## Preferences

### Volume Settings

**Preferences**

**Volume Settings**

Handset Input Gain  Handset Volume

Table 53 :Volume settings

Field Name	Description
Handset Input Gain	Adjust the handset input gain from 0 to 7.
Handset Volume	Adjust the output gain from 0 to 7.

## Regional

**Regional**

Tone Type USA ▼

Dial Tone

Busy Tone

Off Hook Warning Tone

Ring Back Tone

Call Waiting Tone

Ringing Cadence

Min Jitter Delay(0-600ms)  Max Jitter Delay(20-1000ms)

Ringing Time(10-300sec)

Ring Waveform Sinusoid ▼ Ring Voltage(40-63 Vrms)

Ring Frequency(15-30Hz)  VMWI Ring Splash Len(0.1-10sec)

Flash Time Max(0.2-1sec)  Flash Time Min(0.1-0.5sec)

Table 54 :Regional

Field Name	Description																
Tone Type	<p>Choose tone type as UK, China, US, Hong Kong and so on. A sample Tone Type for UK is shown below:</p> <table border="1" style="width: 100%; border-collapse: collapse; margin: 10px 0;"> <thead> <tr style="background-color: #cccccc;"> <th style="width: 50%;">COUNTRY/PARAMETER</th> <th>VALUE</th> </tr> </thead> <tbody> <tr> <td><b>U.K</b></td> <td></td> </tr> <tr> <td>Dial tone</td> <td>350@-19;440@-19;30(*0/1+2)</td> </tr> <tr> <td>Busy tone</td> <td>400@-19;30(.375/.375/1)</td> </tr> <tr> <td>Ring Back Tone</td> <td>400@-19;450@-19;10(0.4/0.2/1+2,0.4/2.0/1+2)</td> </tr> <tr> <td>On-hook Voltage</td> <td>50Vrms</td> </tr> <tr> <td>Impedance Maching</td> <td>370+620    310nF</td> </tr> <tr> <td>Ring Voltage</td> <td>55Vrms</td> </tr> </tbody> </table> <div style="display: flex; align-items: flex-start; margin-top: 10px;"> <div style="margin-right: 10px;">  </div> <div style="background-color: #e6f2ff; padding: 5px; border: 1px solid #ccc;"> <p><b>Note</b></p> <p>Currently, selecting a particular country does not load the correct Ringing parameters as per standard. If standard based ringing cadence is desired, then the user has to select <b>Custom</b> option from the drop-down list and enter the country specific parameters manually.</p> </div> </div>	COUNTRY/PARAMETER	VALUE	<b>U.K</b>		Dial tone	350@-19;440@-19;30(*0/1+2)	Busy tone	400@-19;30(.375/.375/1)	Ring Back Tone	400@-19;450@-19;10(0.4/0.2/1+2,0.4/2.0/1+2)	On-hook Voltage	50Vrms	Impedance Maching	370+620    310nF	Ring Voltage	55Vrms
COUNTRY/PARAMETER	VALUE																
<b>U.K</b>																	
Dial tone	350@-19;440@-19;30(*0/1+2)																
Busy tone	400@-19;30(.375/.375/1)																
Ring Back Tone	400@-19;450@-19;10(0.4/0.2/1+2,0.4/2.0/1+2)																
On-hook Voltage	50Vrms																
Impedance Maching	370+620    310nF																
Ring Voltage	55Vrms																

Field Name	Description
Dial Tone	Dial Tone
Busy Tone	Busy Tone
Off Hook Warning Tone	Off Hook warning tone
Ring Back Tone	Ring back tone
Call Waiting Tone	Call waiting tone
Ringing Cadence	The ringing pattern heard by the dialer before the called party picks up the call.
Min Jitter Delay	The Min value of home gateway's jitter delay, home gateway is an adaptive jitter mechanism
Max Jitter Delay	The Max value of home gateway's jitter delay, home gateway is an adaptive jitter mechanism
Ringing Time	How long cnPilot r190V/r190W/r200/r200P Routers will ring when there is an incoming call
Ring Waveform	Select regional ring waveform, options are Sinusoid and Trapezoid, the default Sinusoid
Ring Voltage	Set ringing voltage, the default value is 70
Ring Frequency	Set ring frequency, the default value is 25
VMWI Ring Splash Len(sec)	Set the VMWI ring splash length, default is 0.5s
Flash Time Max (sec)	Set the Max value of the device's flash time, the default value is 0.9
Flash Time Min (sec)	Set the Min value of the device's flash time, the default value is 0.1

## Features and Call Forward

Features			
All Forward	Disable ▼	Busy Forward	Disable ▼
No Answer Forward	Disable ▼		
Call Forward			
All Forward	<input type="text"/>	Busy Forward	<input type="text"/>
No Answer Forward	<input type="text"/>	No Answer Timeout	20
Feature Code			
Hold Key Code	*77	Conference Key Code	*88
Transfer Key Code	*98	IVR Key Code	****
R Key Enable	Disable ▼	R Key Cancel Code	R1 ▼
R Key Hold Code	R2 ▼	R Key Transfer Code	R4 ▼
R Key Conference Code	R3 ▼	Speed Dial Code	*74

Table 55 :Features and call forward

Field Name		Description
Features	All Forward	Enable/Disable forward all calls
	Busy Forward	Enable/Disable busy forward
	No Answer Forward	Enable/Disable no answer forward
Call Forward	All Forward	Set the target phone number for all forward. The device will forward all calls to the phone number immediately when there is an incoming call.
	Busy Forward	The phone number which the calls will be forwarded to when line is busy
	No Answer Forward	The phone number which the call will be forwarded to when there's no answer
	No Answer Timeout	The seconds to delay forwarding calls, if there is no answer at your phone

Field Name	Description	
Feature Code	Hold key code	Call hold signatures, default is *77
	Conference key code	Signature of the tripartite session, default is *88
	Transfer key code	Call forwarding signatures, default is *98
	IVR key code	Signatures of the voice menu, default is ****
	R key enable	Enable/Disable R key way call features
	R key cancel code	Set the R key cancel code, options are ranged from R1 to R9, default value is R1
	R key hold code	Set the R key hold code, options are ranged from R1 to R9, default value is R2
	R key transfer code	Set the R key transfer code, options are ranged from R1 to R9, default value is R4
	R key conference code	Set the R key conference code, options are ranged from R1 to R9, default value is R3
	Speed Dial Code	Speed dial code, default is *74

## Miscellaneous

**Miscellaneous**

Codec Loop Current: <input type="text" value="26"/>	Impedance Matching: <input type="text" value="US PBX,Korea,Taiwan(600)"/>
CID Service: <input type="text" value="Enable"/>	CWCID Service: <input type="text" value="Disable"/>
Caller ID Method: <input type="text" value="Bellcore"/>	Polarity Reversal: <input type="text" value="Disable"/>
Dial Time Out(IDT): <input type="text" value="5"/>	Call Immediately Key: <input type="text" value="#"/>
ICMP Ping: <input type="text" value="Disable"/>	Escaped char enable: <input type="text" value="Disable"/>
Bellcore Style 3-Way Conference: <input type="text" value="Disable"/>	



**Warning**  
3-wire connection is not supported.

Table 56 :Miscellaneous

Field Name	Description
Codec Loop Current	Set off-hook loop current, default is 26
Impedance Matching	Set impedance matching, default is US PBX, Korea, Taiwan (600)
CID service	Enable/Disable displaying caller ID; If enable, caller ID is displayed when there is an

Field Name	Description
	incoming call or it won't be displayed. Default is Enable
CWCID Service	Enable/Disable CWCID. If enable, the device will display the waiting call's caller ID, or it won't display. Default is Disable
Dial Time Out	How long cnPilot Home Router will sound dial out tone
Call Immediately Key	Choose call immediately key form * or #
ICMP Ping	Enable/Disable ICMP Ping. If enable this option, home gateway will ping the SIP Server every interval time, otherwise, It will send "hello" empty packet to the SIP Server.
Escaped char enable	Open special character translation function; if enable, when you press the # key, it will be translated to 23%, when disable, it is just #

## FXS2

The settings of FXS2 are the same as FXS1. See FXS1 on page "FXS1" on page 109.



# Security

## Filtering Setting

### Basic Settings

**Basic Settings**

Filtering  ▾

Default Policy  ▾

The packet that don't match with any rules would beDrop

---

**IP/Port Filter Settings**

Mac address

Dest IP Address

Source IP Address

Protocol  ▾

Dest. Port Range  -

Src Port Range  -

Action  ▾

Comment

( The maximum rule count is 32 )

Table 57 :Filtering setting

Field Name	Description
Filtering	Enable/Disable filter function
Default Policy	Choose to drop or accept filtered MAC addresses
Mac address	Add the Mac address filtering
Dest IP address	Destination IP address
Source IP address	Source IP address
Protocol	Select a protocol name, support for TCP, UDP and TCP/UDP
Dest. Port Range	Destination port ranges
Src Port Range	Source port range
Action	You can choose to accept or drop; this should be consistent with the default policy.

Field Name	Description
Comment	Add callout
Delete	Delete selected item

## Content Filtering

Table 58 :Content filtering

**Basic Settings**

**Basic Settings**

Filtering Disable ▾

Default Policy Drop ▾

The packet that don't match with any rules would be Drop

---

**IP/Port Filter Settings**

Interface LAN ▾

Mac address LAN

Dest IP Address WAN

Source IP Address

Protocol NONE ▾

Dest. Port Range  -

Src Port Range  -

Action Accept ▾

Comment

( The maximum rule count is 32 )

Field Name	Description
Filtering	Enable/Disable content Filtering
Default Policy	The default policy is to accept or to prohibit filtering rules
Current Webs URL Filters	List the URL filtering rules that already existed (blacklist)
Delete/Cancel	You can choose to delete or cancel the existing filter rules
Add a URL Filter	Add URL filtering rules
Add/Cancel	Click adds to add one rule or click cancel
Current Website Host Filters	List the keywords that already exist (blacklist)
Delete/Cancel	You can choose to delete or cancel the existing filter rules the existing keywords
Add a Host Filter (Keyword)	Add keywords
Add/Cancel	Click the Add or cancel

# Application

## UPnP

UPnP (Universal Plug and Play) supports zero-configuration networking and can automatically discover a variety of networked devices. When UPnP is enabled, the connected device can access the network, obtain an IP address, and convey performance information. If the network has a DHCP and DNS server, the connected device can automatically obtain DHCP and DNS services. UPnP devices can be automatically added to the network without affecting previously connected devices.

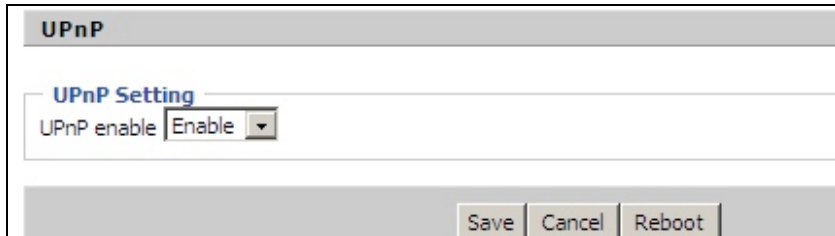

Table 59 :UPnP

Field Name	Description
UPnP enable	Enable/Disable UPnP function.

## IGMP

Multicast has ability to send the same data to multiple devices.

IP hosts use IGMP (Internet Group Management Protocol) report multicast group memberships to the neighboring routers to transmit data, at the same time, the multicast router use IGMP to discover which hosts belong to the same multicast group.

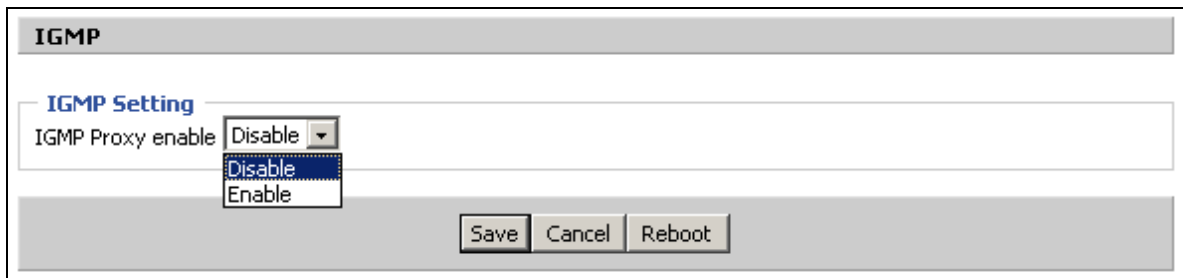

Table 60 :IGMP

Field Name	Description
IGMP Proxy enable	Enable/Disable IGMP function.

# Storage

## Disk Management

This page is used to manage the USB storage device.

Status	Network	Wireless	SIP	FXS1	FXS2	Security	Application	<b>Storage</b>
Disk Management		Ftp Setting	Smb Setting					
<b>Disk Management</b>								
<b>Folder List</b>								
Directory Path				Partition				
			Add	Delete	RemoveDisk			
<b>Partition Status</b>								
Partition			Path					
			Format	Re-allocate				

Table 61 :Disk Management

Field Name	Description
Add	Adding files to the USB storage device
Delete	Remove the USB storage device file
Remove Disk	Transfer files within a USB storage device
Format	Format the USB storage device
Re-allocate	Reset the USB storage device



**Note**

Only **FAT/FAT32** USB drive formats are supported. Other file systems like **NTFS/EXT2/EXT3** will not be detected.

## FTP Setting

Status	Network	Wireless	SIP	FXS1	FXS2	Security	Application	Storage
Disk Management		Ftp Setting		Smb Setting				
<b>FTP Setting</b>								
<b>FTP Server Setup</b>								
FTP Server			<input type="radio"/> Enable		<input checked="" type="radio"/> Disable			
FTP Server Name	<input type="text" value="FTP"/>							
Anonymous Login			<input type="radio"/> Enable		<input checked="" type="radio"/> Disable			
FTP Port	<input type="text" value="21"/>							
Max. Sessions	<input type="text" value="10"/>							
Create Directory			<input checked="" type="radio"/> Enable		<input type="radio"/> Disable			
Rename File/Directory			<input checked="" type="radio"/> Enable		<input type="radio"/> Disable			
Remove File/Directory			<input checked="" type="radio"/> Enable		<input type="radio"/> Disable			
Read File			<input checked="" type="radio"/> Enable		<input type="radio"/> Disable			
Write File			<input checked="" type="radio"/> Enable		<input type="radio"/> Disable			
Download Capability			<input checked="" type="radio"/> Enable		<input type="radio"/> Disable			
Upload Capability			<input checked="" type="radio"/> Enable		<input type="radio"/> Disable			

Table 62 : FTP Setting

Field Name	Description
FTP Server	Enable/Disable FTP server
FTP Server Name	Set the FTP server name
Anonymous Login	If or not support anonymous login
FTP Port	Set FTP server port number
Max. Sessions	Maximum number of connections
Create Directory	Enable/Disable create directory
Rename File/Directory	Enable/Disable rename file/directory
Remove File/Directory	Enable/Disable transfer of files/directories
Read File	Enable/Disable read files
Write File	Enable/Disable write files
Download Capability	Enable/Disable download capability function.
Upload Capability	Enable/Disable upload capability function

## Smb Setting

Table 63 : Smb setting

Field Name	Description
SAMBA Server	Enable/Disable SAMBA server
Workgroup	Enter the working group
NetBIOS Name	Network basic input/output system name
Add	Add a shared file
Edit	Edit a shared file
Del	Delete a shared file
Add	Add a shared file
Edit	Edit a shared file
Del	Delete a shared file

## Administration

The user can manage the device in these webpages; you can configure the Time/Date, password, web access, system log and associated configuration TRO69.

## Management

### Save config file

**Save Config File**

**Config File Upload && Download**

Local File Choose File No file chosen

Upload Download

Table 64 :Save Config File

Field Name	Description
Config file upload and download	Upload: click on browse, select file in the local, press the upload button to begin uploading files.
	Download: click to download, and then select contains the path to download the configuration file.

## Administrator settings

Table 65 : Administrator settings

**Administrator Settings**

**Password Reset**

User Type Admin User ▼

New User Name admin

New Password (The maximum length is 25)

Confirm Password

**Language**

Language English ▼

**VPN Access**

Management Using VPN Disable ▼

**Web Access**

Remote Web Login Enable ▼

Allow Wireless host Disable ▼

Local Web Port 80

Web Port 80

Web SSL Port 443

Web Idle Timeout(0 - 60min) 5

Allowed Remote IP(IP1;IP2;...)  
0.0.0.0

**SSH Access**

Remote SSH Disable ▼

Local SSH Enable ▼

SSH Port 22

**HostName**

HostName cnPilot-R190V

**Time/Date Setting**

**NTP Settings**

NTP Enable: Enable ▾  
Option 42: Disable ▾  
Current Time: 2017 - 06 - 09 . 11 : 04 : 33  
Sync with host: Sync with host  
Time Zone: (GMT-06:00) Central Time ▾  
Primary NTP Server: pool.ntp.org  
Secondary NTP Server:   
NTP synchronization(1 - 1440min): 60

**Daylight Saving Time**

Daylight Saving Time: Disable ▾

**System Log Setting**

**Syslog Setting**

Syslog Enable: Enable ▾  
Syslog Level: INFO ▾  
Login Syslog Enable: Enable ▾  
Call Syslog Enable: Enable ▾  
Net Syslog Enable: Enable ▾  
Device Management Syslog Enable: Enable ▾  
Device Alarm Syslog Enable: Enable ▾  
Kernel Syslog Enable: Enable ▾  
Remote Syslog Enable: Disable ▾  
Remote Syslog Server:

**Factory Defaults Setting**

**Factory Defaults Setting**

Factory Defaults Lock: Disable ▾

**Factory Defaults**

Reset to Factory Defaults:

Field Name	Description
User type	Choose the user type from admin user and normal user and basic user
New User Name	You can modify the user name, set up a new user name
New Password	Input the new password
Confirm Password	Input the new password again
Language	Select the language for the web, the device support Chinese, English, and Spanish etc.
<b>Management using VPN</b>	
Remote Web Login	Enable/Disable remote Web login
Allow wireless host	To allow all the wireless clients connected to the cnPilot Home Router to access the management interface
Local Web Port	Set the port value which is used to login from Internet port and PC port, default is 80



Field Name	Description
Web Idle timeout	Set the Web Idle timeout time. The webpage can be logged out after Web Idle Timeout without any operation
Allowed Remote IP (IP1, IP2,...)	Set the IP from which a user can login the device remotely
SSH	Enable/Disable telnet

## Enabling Management access for wireless clients

To allow all the wireless clients connected to the cnPilot Home Router to access the management interface:

1. Navigate to **Administrator** tab.
2. Enable **Allow Wireless Host** option under **Web Access**.

The user must have administrator permissions to make this change.

## Enabling SNMP access over WAN

To enable SNMP access over WAN:

1. Navigate to **Administrator > SNMP** tab.
2. Enable **Remote SNMP Login** option.

The user must have administrator permissions to make this change.

The screenshot displays the 'SNMP Configuration' page within the router's web interface. The navigation tabs at the top include Status, Network, Wireless 2.4GHz, Wireless 5GHz, SIP, FXS1, FXS2, Security, Application, Storage, and Administration. The sub-navigation tabs include Management, Firmware Upgrade, Scheduled Tasks, Certificates, Provision, SNMP, TR069, Rflow, cnMaestro, and Diagnosis. The main content area is titled 'SNMP Configuration' and contains the following fields:

- SNMP Service: Enable (dropdown menu)
- Remote SNMP login: Disable (dropdown menu)
- Trap Server Address: (text input field)
- Read Community Name: public (text input field)
- Write Community Name: private (text input field)
- Trap Community: trap (text input field)
- Trap period interval(sec): 300 (text input field)

At the bottom of the configuration area, there are three buttons: Save, Cancel, and Reboot. A 'Help' section on the right side of the page provides additional information: 'SNMP Configuration: Allow the device to be managed by the Manager which is set in the SNMP Manager IP.'

## NTP settings

**Time/Date Setting**

**NTP Settings**

NTP Enable Enable ▼

Option 42 Disable ▼

Current Time 2016 - 01 - 19 . 05 : 55 : 06

Sync with host

NTP Settings (GMT-06:00) Central Time ▼

Primary NTP Server

Secondary NTP Server

NTP synchronization(1 - 1440min)

**Daylight Saving Time**

Daylight Saving Time Disable ▼

Table 66 : NTP settings

Field Name	Description
NTP Enable	Enable/Disable NTP
Option 42	Enable/Disable DHCP option 42. This option specifies a list of the NTP servers available to the client by IP address
Current Time	Display current time
NTP Settings	Setting the Time Zone
Primary NTP Server	Primary NTP server's IP address or domain name
Secondary NTP Server	Options for NTP server's IP address or domain name
NTP synchronization	NTP synchronization cycle, cycle time can be 1 to 1440 minutes in anyone, the default setting is 60 minutes

## Daylight Saving Time

Daylight Saving Time	
Daylight Saving Time	Enable ▾
Offset	60 <input type="text"/> Min.
Start Month	April ▾
Start Day of Week	Sunday ▾
Start Day of Week Last in Month	First in Month ▾
Start Hour of Day	2 <input type="text"/>
Stop Month	October ▾
Stop Day of Week	Sunday ▾
Stop Day of Week Last in Month	Last in Month ▾
Stop Hour of Day	2 <input type="text"/>

Table 67 : Daylight Saving Time

Steps	Procedure
1	Enable Daylight Savings Time.
2	Set value of offset for Daylight Savings Time
3	Set starting Month/Week/Day/Hour in Start Month/Start Day of Week Last in Month/Start Day of Week/Start Hour of Day, analogously set stopping Month/Week/Day/Hour in Stop Month/Stop Day of Week Last in Month/Stop Day of Week/Stop Hour of Day.
4	Press Saving button to save and press Reboot button to active changes.

## System Log Setting

System Log Setting	
Syslog Setting	
Syslog Enable	Enable ▾
Syslog Level	INFO ▾
Remote Syslog Enable	Disable ▾
Remote Syslog Server	<input type="text"/>

Table 68 : System log Setting

Field Name	Description
Syslog Enable	Enable/Disable syslog function
Syslog Level	Select the system log, there is INFO and Debug two grades, the Debug INFO can provide more information.

Field Name	Description
Remote Syslog Enable	Enable/Disable remote syslog function.
Remote Syslog server	Add a remote server IP address.
Syslog Enable	Enable/Disable syslog function
Syslog Level	Select the system log, there is INFO and Debug two grades, the Debug INFO can provide more information.

## Factory Defaults Setting

**Factory Defaults Setting**

**Factory Defaults Setting**

Factory Defaults Lock Disable ▾

Table 69 :Factory Defaults Setting

Description
With this lock enabled, user cannot factory reset the box using the hardware switch.

## Factory Defaults

**Factory Defaults**

Reset to Factory Defaults Factory Default

Table 70 : Factory Defaults

Description
Click Factory Default to restore the cnPilot Home Router to factory settings.

## Firmware Upgrade

Table 71: Firmware upgrade

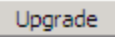
Description
Choose upgrade file type from Image File and Dial Rule
Press “Browse” button to browse the file
Press  to start upgrading

## Provision

Provisioning allows cnPilot Home Router to auto-upgrade and auto-configure devices which support TFTP, HTTP and HTTPS.

- Before testing or using TFTP, user should have tftp server and upgrading file and configuring file.
- Before testing or using HTTP, user should have http server and upgrading file and configuring file.
- Before testing or using HTTPS, user should have https server and upgrading file and configuring file and CA Certificate file (should same as https server’s) and Client Certificate file and Private key file

User can upload a CA Certificate file and Client Certificate file and Private Key file in the Security page.

Status	Network	Wireless	SIP	FXS1	FXS2	Security	Application	Storage
Management	Firmware Upgrade	Certification	Provision	SNMP	TR069	Cambium Network Ma		
Operating Mode								
<b>Provision</b>								
<b>Configuration Profile</b>								
Provision Enable	Enable ▾							
Resync On Reset	Enable ▾							
Resync Random Delay(sec)	40							
Resync Periodic(sec)	3600							
Resync Error Retry Delay(sec)	3600							
Forced Resync Delay(sec)	14400							
Resync After Upgrade	Enable ▾							
Resync From SIP	Disable ▾							
Option 66	Enable ▾							
Config File Name	\$(MA)							
User Agent								
Profile Rule								

Table 72 : Provision

Field Name	Description
Provision Enable	Enable provision or not
Resync on Reset	Enable re-sync after restart or not
Resync Random Delay(sec)	Set the maximum delay for the request of synchronization file. The default is 40
Resync Periodic(sec)	If the last resync was failure, cnPilot r190V/r190W/r200/r200P Routers will retry resync after the “Resync Error Retry Delay” time, default is 3600s
Resync Error Retry Delay(rec)	Set the periodic time for resync, default is 3600s
Forced Resync Delay(sec)	If it’s time to resync, but cnPilot r190V/r190W/r200/r200P Router is busy now, in this case, cnPilot r190V/r190W/r200/r200P Router will wait for a period time, the longest is “Forced Resync Delay”, default is 14400s, when the time over, cnPilot r190V/r190W/r200/r200P Router will be forced to re-sync
Resync After Upgrade	Enable firmware upgrade after re-sync or not. The default is Enabled

Field Name	Description
Resync From SIP	Enable/Disable re-sync from SIP
Option 66	It is used for In-house provision mode only. When use TFTP with option 66 to realize provisioning, user must input right configuration file name in the web page. When disable Option 66, this parameter has no effect
Config File Name	It is used for In-house provision mode only. When use TFTP with option 66 to realize provisioning, user must input right configuration file name in the web page. When disable Option 66, this parameter has no effect
Profile Rule	URL of profile provision file  Note that the specified file path is relative to the TFTP server's virtual root directory.

**Firmware Upgrade**

Upgrade Enable

Upgrade Error Retry Delay(sec)

Upgrade Rule

Table 73: Firmware Upgrade

Field Name	Description
Upgrade Enable	Enable firmware upgrade via provision or not
Upgrade Error Retry Delay(sec)	If the last upgrade fails, cnPilot r190V/r190W/r200/r200P Routers will try upgrading again after "Upgrade Error Retry Delay" period, default is 3600s
Upgrade Rule	URL of upgrade file

## SNMP

Management	Firmware Upgrade	Certification	Provision	SNMP	TR069	Cambium Network Ma
Operating Mode						
<b>SNMP Configuration</b>						
<b>SNMP Configuration</b>						
SNMP Service						Enable ▾
Trap Server Address						<input type="text"/>
Read Community Name						public
Write Community Name						private
Trap Community						trap
Trap period interval(sec)						300

Table 74 : SNMP

Field Name	Description
SNMP Service	Enable or Disable the SNMP service
Trap Server Address	Enter the trap server address for sending SNMP traps
Read Community Name	String value that is used as a password to request information via SNMP from the device
Write Community Name	String value that is used as a password to write configuration values to the device via SNMP
Trap Community	String value used as a password for retrieving traps from the device
Trap period interval (sec)	The interval for which traps are sent from the device

## TR-069

TR-069 provides the possibility of auto configuration of internet access devices and reduces the cost of management. TR-069 (short for Technical Report 069) is a [DSL Forum](#) technical specification entitled [CPE WAN](#) Management Protocol (CWMP). It defines an [application layer](#) protocol for remote management of end-user devices. Using TR-069, the terminals establish connection with the Auto Configuration Servers (ACS) and get configured automatically.

### Device Configuration using TR-069

The TR-069 configuration page is available under Administration menu.



Management	Firmware Upgrade	Certification	Provision	SNMP	TR069	Cambium Network Man
Operating Mode						
<b>TR069 Configuration</b>						
<b>ACS</b>						
TR069 Enable		Disable ▾				
CWMP		Enable ▾				
ACS URL		<input type="text"/>				
User Name		000456-C3VoIP-200P-400FQU001GLX				
Password		.....				
Periodic Inform Enable		Enable ▾				
Periodic Inform Interval		30				
<b>Connect Request</b>						
User Name		<input type="text"/>				
Password		<input type="text"/>				

Table 75 :TR069

Field Name	Description
ACS parameters	
TR069 Enable	Enable or Disable TR069
CWMP	Enable or Disable CWMP
ACS URL	ACS URL address
User Name	ACS username
Password	ACS password
Periodic Inform Enable	Enable the function of periodic inform or not. By default, it is Enabled.
Periodic Inform Interval	Periodic notification interval with the unit in seconds. The default value is 43200s.
<b>Connect Request parameters</b>	
User Name	The username used to connect the TR069 server to the DUT.
Password	The password used to connect the TR069 server to the DUT.

## TR-069 Profile

Under nodes base on TR098, TR104 and TR111.

```
{ "InternetGatewayDevice", },
  { "DeviceSummary", },
  { "LANDeviceNumberOfEntries", },
  { "WANDeviceNumberOfEntries", },
  { "DeviceInfo", },
    { "Manufacturer", },
    { "ManufacturerOUI", },
    { "ModelName", },
    { "Description", },
    { "ProductClass", },
    { "SerialNumber", },
    { "HardwareVersion", },
    { "SoftwareVersion", },
    { "SpecVersion", },
    { "ProvisioningCode", },
    { "UpTime", },
    { "DeviceLog", },
  { "", },

  { "ManagementServer", },
    { "URL", },
    { "Username", },
    { "Password", },
    { "PeriodicInformEnable", },
    { "PeriodicInformInterval", },
    { "PeriodicInformTime", },
    { "ParameterKey", },
    { "ConnectionRequestURL", },
    { "ConnectionRequestUsername", },
    { "ConnectionRequestPassword", },
    { "UpgradesManaged", },
    { "UDPConnectionRequestAddress", },
```

```
    {"UDPConnectionRequestAddressNotificationLimit", },
    {"STUNEnable", },
    {"STUNServerAddress", },
    {"STUNServerPort", },
    {"STUNUsername", },
    {"STUNPassword", },
    {"STUNMaximumKeepAlivePeriod", },
    {"STUNMinimumKeepAlivePeriod", },
    {"NATDetected", },
    {"", },
```

```
    {"UPnP", },
        {"Device", },
        {"UPnPIGD", },
        {"", },
    {"", },
```

```
    {"IPPingDiagnostics", },
        {"DiagnosticsState", },
        {"Interface", },
        {"Host", },
        {"NumberOfRepetitions", },
        {"Timeout", },
        {"DataBlockSize", },
        {"DSCP", },
        {"SuccessCount", },
        {"FailureCount", },
        {"AverageResponseTime", },
        {"MinimumResponseTime", },
        {"MaximumResponseTime", },
    {"", },
```

```
    {"DownloadDiagnostics", },
```

```

    {"DiagnosticsState", },
    {"Interface", },
    {"DownloadURL", },
    {"DSCP", },
    {"EthernetPriority", },
    {"ROMTime", },
    {"BOMTime", },
    {"EOMTime", },
    {"TestBytesReceived", },
// {"TotalBytesReceived", },
    {"TCPOpenRequestTime", },
    {"TCPOpenResponseTime", },
    {"", },

{"UploadDiagnostics", },
    {"DiagnosticsState", },
    {"Interface", },
    {"UploadURL", },
    {"DSCP", },
    {"EthernetPriority", },
    {"TestFileLength", },
    {"ROMTime", },
    {"BOMTime", },
    {"EOMTime", },
// {"TotalBytesSent", },
    {"TCPOpenRequestTime", },
    {"TCPOpenResponseTime", },
    {"", },

{"Time", },
    {"NTPServer1", },
    {"NTPServer2", },
    {"", },

```

```

{"UserInterface", },
  {"User", },
    {"1", },
      {"Enable", },
      {"RemoteAccessCapable", },
      {"X_WebPort", },
      {"X_WebIdleTimeout", },
      {"X_WebAllowRemoteIP", },
      {"Username", },
      {"Password", },
    {"", },
  {"", },
{"", },

```

```

{"Layer3Forwarding", },
  {"DefaultConnectionService", },
  {"ForwardNumberOfEntries", },
  {"Forwarding", },
    {"1", },
      {"Enable", },
      {"Status", },
      {"Type", },
      {"DestIPAddress", },
      {"DestSubnetMask", },
      {"SourceIPAddress", },
      {"SourceSubnetMask", },
      {"GatewayIPAddress", },
      {"Interface", },
      {"ForwardingMetric", },
    {"", },
  {"", },
{"", },

```

```

{"LANConfigSecurity", },
  {"ConfigPassword", },
  {"", },

{"LANDevice", },
  {"1", },
    {"LANEthernetInterfaceNumberOfEntries", },
    {"LANUSBInterfaceNumberOfEntries", },
    {"LANWLANConfigurationNumberOfEntries", },
    {"LANHostConfigManagement", },
      {"DHCPServerConfigurable", },
      {"DHCPServerEnable", },
      {"DHCPRelay", },
      {"MinAddress", },
      {"MaxAddress", },
      {"ReservedAddresses", },
      {"SubnetMask", },
      {"DNSServers", },
      {"DomainName", },
      {"IPRouters", },
      {"DHCPLeaseTime", },
      {"IPInterfaceNumberOfEntries", },
      {"IPInterface", },
        {"1", },
          {"Enable", },
          {"IPInterfaceIPAddress", },
          {"IPInterfaceSubnetMask", },
          {"IPInterfaceAddressingType", },
          {"", },
          {"", },
        {"", },
      {"LANEthernetInterfaceConfig", },
        {"1", },

```

```

    {"Enable", },
    {"Status", },
    {"MACAddress", },
    {"MACAddressControlEnabled", },
    {"MaxBitRate", },
    {"DuplexMode", },
    {"", },
{"", },
{"WLANConfiguration", },
    {"1", },
        {"Enable", },
        {"Status", },
        {"BSSID", },
        {"MaxBitRate", },
        {"Channel", },
        {"AutoChannelEnable", },
        {"SSID", },
        {"BeaconType", },
        {"MACAddressControlEnabled", },
        {"Standard", },
        {"WEPKeyIndex", },
        {"KeyPassphrase", },
        {"WEPEncryptionLevel", },
        {"BasicEncryptionModes", },
        {"BasicAuthenticationMode", },
        {"WPAEncryptionModes", },
        {"WPAAuthenticationMode", },
        {"IEEE11iEncryptionModes", },
        {"IEEE11iAuthenticationMode", },
        {"PossibleChannels", },
        {"ChannelsInUse", },
        {"BasicDataTransmitRates", },
        {"OperationalDataTransmitRates", },
        {"PossibleDataTransmitRates", },

```

```

    {"RadioEnabled", },
    {"AutoRateFallBackEnabled", },
    {"TotalBytesSent", },
    {"TotalBytesReceived", },
    {"TotalPacketsSent", },
    {"TotalPacketsReceived", },
    {"TotalAssociations", },
    {"AssociatedDevice", },
        {"1", },
            {"AssociatedDeviceMACAddress", },
            {"AssociatedDeviceIPAddress", },
            {"AssociatedDeviceAuthenticationState", },
            {"X_AssociatedDeviceSignalStrength", },
            {"", },
        {"", },
    {"WEPKey", },
        {"1", },
            {"WEPKey", },
            {"", },
        {"", },

    {"", },
    {"", },

{"Hosts", },
    {"HostNumberOfEntries", },
    {"Host", },
        {"1", },
            {"IPAddress", },
            {"AddressSource", },
            {"LeaseTimeRemaining", },
            {"MACAddress", },
            {"HostName", },
            {"InterfaceType", },

```



```

        {"Active", },
        {"", },
        {"", },
        {"", },
        {"", },
        {"", },
        {"", },

{"WANDevice", },
    {"I", },
        {"WANConnectionNumberOfEntries", },
        {"WANCommonInterfaceConfig", },
            {"EnabledForInternet", },
            {"WANAccessType", },
            {"Layer1UpstreamMaxBitRate", },
            {"Layer1DownstreamMaxBitRate", },
            {"PhysicalLinkStatus", },
            {"TotalBytesSent", },
            {"TotalBytesReceived", },
            {"TotalPacketsSent", },
            {"TotalPacketsReceived", },
        {"", },
        {"WANConnectionDevice", },
            {"I", },
                {"WANIPConnectionNumberOfEntries", },
                {"WANPPPConnectionNumberOfEntries", },
                {"WANIPConnection", },
                    {"I", },
                        {"Enable", },
                        {"ConnectionStatus", },
                        {"PossibleConnectionTypes", },
                        {"ConnectionType", },
                        {"Name", },
                        {"Uptime", },

```

```

{"LastConnectionError", },
{"RSIPAvailable", },
{"NATEnabled", },
{"AddressingType", },
{"ExternalIPAddress", },
{"SubnetMask", },
{"DefaultGateway", },
{"DNSEnabled", },
{"DNSOverrideAllowed", },
{"DNSServers", },
{"MACAddress", },
{"ConnectionTrigger", },
{"RouteProtocolRx", },
{"PortMappingNumberOfEntries", },
{"PortMapping", },
  {"I", },
    {"PortMappingEnabled", },
    {"PortMappingLeaseDuration", },
    {"RemoteHost", },
    {"ExternalPort", },
    {"InternalPort", },
    {"PortMappingProtocol", },
    {"InternalClient", },
    {"PortMappingDescription", },
    {"", },
    {"", },
  {"Stats", },
    {"EthernetBytesSent", },
    {"EthernetBytesReceived", },
    {"EthernetPacketsSent", },
    {"EthernetPacketsReceived", },
    {"", },
    {"", },
  {"", },

```

```

{"WANPPPConnection", },
  {"I", },
    {"Enable", },
    {"ConnectionStatus", },
    {"PossibleConnectionTypes", },
    {"ConnectionType", },
    {"Name", },
    {"Uptime", },
    {"LastConnectionError", },
    {"RSIPAvailable", },
    {"NATEnabled", },
    {"Username", },
    {"Password", },
    {"ExternalIPAddress", },
    {"DNSEnabled", },
    {"DNSOverrideAllowed", },
    {"DNSServers", },
    {"MACAddress", },
    {"TransportType", },
    {"PPPoEACName", },
    {"PPPoEServiceName", },
    {"ConnectionTrigger", },
    {"RouteProtocolRx", },
    {"PortMappingNumberOfEntries", },
    {"PortMapping", },
      {"I", },
        {"PortMappingEnabled", },
        {"PortMappingLeaseDuration", },
        {"RemoteHost", },
        {"ExternalPort", },
        {"InternalPort", },
        {"PortMappingProtocol", },
        {"InternalClient", },
        {"PortMappingDescription", },

```



```

{"FaxPassThrough", },
{"ModemPassThrough", },
{"ToneGeneration", },
{"RingGeneration", },
{"NumberingPlan", },
{"ButtonMap", },
{"VoicePortTests", },
{"SIP", },
  {"Role", },
  {"Extensions", },
  {"Transports", },
  {"URISchemes", },
  {"EventSubscription", },
  {"ResponseMap", },
{"", },
{"Codecs", },
  {"1", },
    {"EntryID", },
    {"Codec", },
    {"BitRate", },
    {"PacketizationPeriod", },
    {"SilenceSuppression", },
    {"", },
  {"", },
{"", },
{"VoiceProfile", },
  {"1", },
    {"Enable", },
    {"Reset", },
    {"NumberOfLines", },
    {"Name", },
    {"SignalingProtocol", },
    {"MaxSessions", },
    {"DTMFMethod", },

```

```

{"DTMFMethodG711", },
{"SIP", },
  {"ProxyServer", },
  {"ProxyServerPort", },
  {"ProxyServerTransport", },
  {"RegistrarServer", },
  {"RegistrarServerPort", },
  {"RegistrarServerTransport", },
  {"UserAgentDomain", },
  {"UserAgentPort", },
  {"UserAgentTransport", },
  {"OutboundProxy", },
  {"OutboundProxyPort", },
  {"Organization", },
  {"RegistrationPeriod", },
  {"RegisterExpires", },
  {"UseCodecPriorityInSDPResponse", },
{"", },
{"RTP", },
  {"LocalPortMin", },
  {"LocalPortMax", },
{"DSCPMark", },
  {"TelephoneEventPayloadType", },
{"", },
{"Line", },
  {"1", },
    {"Enable", },
    {"Status", },
    {"CallState", },
    {"SIP", },
      {"AuthUserName", },
      {"AuthPassword", },
      {"URI", },
    {"", },

```

```

{"Codec", },
  {"TransmitCodec", },
  {"ReceiveCodec", },
  {"TransmitBitRate", },
  {"ReceiveBitRate", },
  {"TransmitSilenceSuppression", },
  {"ReceiveSilenceSuppression", },
  {"TransmitPacketizationPeriod", },
  {"List", },
    {"1", },
      {"EntryID", },
      {"Codec", },
      {"BitRate", },
      {"PacketizationPeriod", },
      {"SilenceSuppression", },
      {"Enable", },
      {"Priority", },
    {"", },
  {"", },
{"", },
{"Session", },
  {"1", },
    {"SessionStartTime", },
    {"SessionDuration", },
    {"FarEndIPAddress", },
    {"FarEndUDPPort", },
    {"LocalUDPPort", },
  {"", },
{"", },
{"Stats", },
  {"ResetStatistics", },
  {"PacketsSent", },
  {"PacketsReceived", },
  {"BytesSent", },

```





## Equipment connection configure

The screenshot shows the 'Administration' tab of a network device's configuration page. The 'TR069' sub-tab is selected. A red warning message at the top reads: 'Please REBOOT to make the changes effective!'. The main configuration area is titled 'TR069 Configuration' and is divided into two sections: 'ACS' and 'Connect Request'. The 'ACS' section includes fields for 'TR069 Enable' (set to 'Enable'), 'CWMP' (set to 'Enable'), 'ACS URL' (http://182.92.234.149:8080/tr069), 'User Name' (user\_ip542n), 'Password' (masked with dots), 'Periodic Inform Enable' (set to 'Enable'), and 'Periodic Inform Interval' (600). The 'Connect Request' section includes 'User Name' (11) and 'Password' (masked with dots). At the bottom, there are 'Save', 'Cancel', and 'Reboot' buttons. A 'Help' box on the right provides additional context: 'TR069 Configuration: Allow the device to be managed by the ACS server which is set in the ACS URL.'

## Scheduled Tasks

In this page, the user can set time to automatically turned ON or OFF the Wi-Fi, Reboot, or restart PPPoE at a moment.

The screenshot shows the 'Scheduled Tasks' configuration page. It is divided into three sections: 'Scheduled Wifi', 'Scheduled Reboot', and 'Scheduled PPPOE'. The 'Scheduled Wifi' section features a table with columns for 'No.', 'Enable', 'SSID', 'Week Select', 'Open Time', and 'Close Time'. Below the table are 'Delete Selected', 'Add', and 'Edit' buttons. The 'Scheduled Reboot' section includes 'Scheduled Reboot' (set to 'Disable'), 'Scheduled Mode' (set to 'EveryDay'), and 'Time' (00:00). The 'Scheduled PPPOE' section includes 'Scheduled PPPOE' (set to 'Disable'), 'Scheduled Mode' (set to 'EveryDay'), and 'Time' (00:00).

Table 76 : Scheduled Tasks

Field Name	Description
Scheduled Wi-Fi	Select the Wi-Fi and click Edit to set the timings
Scheduled Reboot	Set values for Scheduled Reboot, Scheduled Mode, and Time.
Scheduled PPPoE	Set values for Scheduled PPPoE, Scheduled Mode, and Time

## Diagnosis

In this page, user can do packet trace, ping test and traceroute test to diagnose the device's connection status.

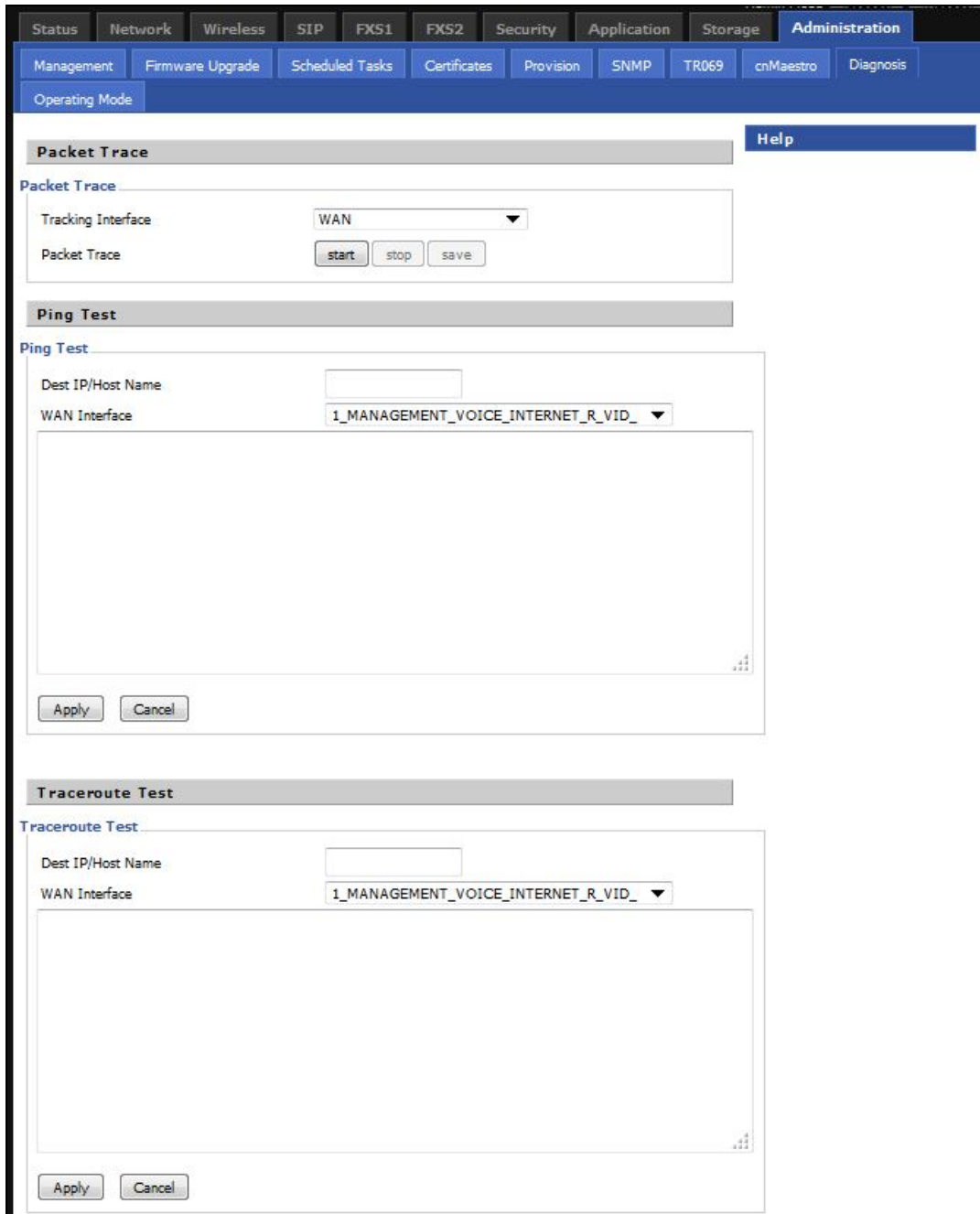

Table 77 :Diagnosis

Description
<p><b>Packet Trace</b></p> <p>Users can use the packet trace feature to intercept packets which traverse the device. Click the Start button to start home gateway tracking and keep refreshing the page until the message trace shows to stop, click the Save button to save captured packets.</p>
<p><b>Ping Test</b></p>

## Description

Enter the destination IP or host name, and then click Apply, device will perform ping test.

The screenshot shows a configuration window with two tabs: "Ping Test" (selected) and "Traceroute Test". The "Ping Test" section contains a text input field for "Dest IP/Host Name" and a dropdown menu for "WAN Interface" set to "1\_TR069\_VOICE\_INTERNET\_R\_VID\_". Below these is a scrollable text area displaying the results of a ping test to www.baidu.com (115.239.210.26). The results show 5 successful pings with varying response times. At the bottom are "Apply" and "Cancel" buttons.

```
PING www.baidu.com (115.239.210.26): 56 data bytes
64 bytes from 115.239.210.26: seq=0 ttl=54 time=43.979 ms
64 bytes from 115.239.210.26: seq=1 ttl=54 time=53.875 ms
64 bytes from 115.239.210.26: seq=2 ttl=54 time=45.226 ms
64 bytes from 115.239.210.26: seq=3 ttl=54 time=49.534 ms
64 bytes from 115.239.210.26: seq=4 ttl=54 time=49.045 ms

--- www.baidu.com ping statistics ---
5 packets transmitted, 5 packets received, 0% packet loss
round-trip min/avg/max = 43.979/48.331/53.875 ms
```

## Traceroute Test

Enter the destination IP or host name, and then click Apply, device will perform traceroute test.

The screenshot shows a configuration window with two tabs: "Traceroute Test" (selected) and "Ping Test". The "Traceroute Test" section contains a text input field for "Dest IP/Host Name" with "www.google.com" entered, and a dropdown menu for "WAN Interface" set to "1\_MANAGEMENT\_VOICE\_INTERNET\_R\_VID\_". Below these is a scrollable text area displaying the results of a traceroute to www.google.com (216.58.208.68). The results show 10 hops with increasing latency. At the bottom are "Apply" and "Cancel" buttons.

```
traceroute to www.google.com (216.58.208.68), 30 hops max, 38 byte packets
 1 10.110.134.254 (10.110.134.254) 1.017 ms 9.507 ms 1.419 ms
 2 * * *
 3 * * *
 4 * * *
 5 * * *
 6 * * *
 7 * * *
 8 * * *
 9 * * *
10 * * *
.. * * *
```

## Operating Mode

The screenshot shows the 'Operating Mode Settings' page. The 'Operating Mode' dropdown menu is open, displaying 'Basic Mode' and 'Advanced Mode'. The 'Basic Mode' option is currently selected. Below the dropdown menu are three buttons: 'Save', 'Cancel', and 'Reboot'.

Table 78 :Operating mode

Description
Choose the Operation Mode as Basic Mode or Advanced Mode (Default).  In Basic mode, multi WAN configuration is not allowed and the device can be configured either as a simple NAT or Bridge device.

## System Log

The screenshot shows the 'System Log' page. The 'Status' tab is selected, and the 'Syslog' sub-tab is active. The log content shows device information: Manufacturer: CAMBIUM NETWORKS, ProductClass: C3VoIP-200P, SerialNumber: 400FQU001GLX, BuildTime: 201506180103, IP: 192.168.11.1, HWVer: V1.3, SWVer: 3.10-b1.

Table 79 :System log

Description
If you enable the system log in Status/syslog webpage, you can view the system log in this webpage.

## Logout

The screenshot shows the Cambium Networks web interface. The 'Administration' tab is selected, and the 'Logout' button is visible. The page also shows the firmware version (3.10) and current time (2015-06-15 17:32:00).

Table 80 :Logout

Description
-------------

Press the logout button to logout, and then the login window will appear.
---

## Reboot

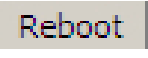
Press the  button to reboot cnPilot Home Routers.

# Chapter 4: Troubleshooting

---

This chapter covers:

- Configuring PC to get IP Address automatically
- Cannot connect to the Web GUI
- Forgotten Password
- cnMaestro On-boarding troubleshooting

## Configuring PC to get IP Address automatically

Refer the [Quick Start Guide to configure your PC to get IP Address automatically.](#)

## Cannot connect to the Web GUI

**Solution:**

- Check if the Ethernet cable is properly connected.
- Connect to LAN port and access [https://192.168.11.1\\_or\\_http://192.168.11.1](https://192.168.11.1_or_http://192.168.11.1). [Check on any other browser apart from Internet explorer such as Firefox or Mozilla.](#)
- Contact your administrator, supplier or ISP for more information or assistance.

## Forgotten Password

The default password is admin/admin user/user, however if it had been changed to non-default, then factory reset may be required.



**Note**

On factory reset, all the device configurations will be reset to the default.

Solution:

To factory default: press and hold reset button for 10 seconds.

If device is onboarded in cnMaestro then password can be set via config push.

## cnMaestro On-boarding troubleshooting

The On-boarding troubleshooting procedure is described below:

1	If during the Cambium ID on boarding if the device dashboard or home page shows the cnMaestro Connection status as
---	--

Error Status	Cause	Resolution
Failed to Resolve URL	The cloud URL is not being resolved by the device.	Ensure that the correct cnMaestro URL is configured.  If the URL is correct, check the DNS settings and Internet connectivity.  If the Internet connectivity and DNS works fine then check the firewall configuration for device IP Address and the protocols http/https/SSL are allowed as part of ACL.
Invalid Cambium ID/Password	Wrong configuration of cambium ID or On Boarding key	Ensure that the correct credentials are entered.
Invalid Cookie or Cambium ID not configured	Device is unclaimed	Claim the device either by serial number or Cambium ID
Device Not Claimed	Device is not claimed	Claim the device either by serial number or Cambium ID
Connecting	Device is trying to connect to the cnMaestro server	Device is in connecting state

2 During the serial number on boarding following are the error messages:

Error Status	Cause	Resolution
Unknown Device	Device serial number is not known to cnMaestro server	Send a mail to <a href="mailto:solutions@cambiumnetworks.com">solutions@cambiumnetworks.com</a> for the serial numbers to be added to the server database.
Invalid Serial Number	Device serial number is less than 12 characters and given for claiming	Enter the correct serial number of the device or try on boarding using Cambium ID.
Already Managed by this account	Device is already managed by the current user account	Do not try both the serial number and cambium ID on boarding methods at the same time.
Already Managed by other Account	Device is already claimed in another user account	Ensure that the entered serial number of device belongs to current user account.

After the error messages occurs, user can click the OK button in the error dialog and then rectify the serial numbers by giving correct ones and initiate the claiming procedure.



	Else, use can clear the wrong serial numbers if it need not to be claimed. This allows not to re-enter serial number again and remove the invalid characters from entered serial number.
3	cnMaestro Account ID is the Cambium ID or Account Name chosen while creating the company account which indicates that the device belongs to that account. cnMaestro Account ID will be blank when the device is not claimed and will be populated when the device is claimed in the cnMaestro server. The Account ID will be available in the device dashboard or home page.

## Appendix: Third Party Software

The software may contain one or more items of Third-Party Software supplied by other third-party suppliers. The terms of this Agreement govern your use of any Third-Party Software license is included, in which case your use of the unless a separate third-party software license is included, in which case your use of the third-party software will then be governed by the separate third-party license.

Zap	<p>Copyright (c) 2004-2009, Ruckus Wireless, Inc.</p> <p>All rights reserved.</p> <p>Redistribution and use in source and binary forms, with or without modification are permitted provided that the following conditions are met:</p> <ul style="list-style-type: none"><li>* Redistributions of source code must retain the above copyright notice, this list of conditions and the following disclaimer.</li><li>* Redistributions in binary form must reproduce the above copyright notice, this list of conditions and the following disclaimer in the documentation and/or other materials provided with the distribution.</li><li>* Neither the name of Ruckus Wireless nor the names of its contributors may be used to endorse or promote products derived from this software without specific prior written permission.</li></ul> <p>THIS SOFTWARE IS PROVIDED BY THE COPYRIGHT HOLDERS AND CONTRIBUTORS "AS IS" AND ANY EXPRESS OR IMPLIED WARRANTIES, INCLUDING, BUT NOT LIMITED TO, THE IMPLIED WARRANTIES OF MERCHANTABILITY AND FITNESS FOR A PARTICULAR PURPOSE ARE DISCLAIMED. IN NO EVENT, SHALL COPYRIGHT HOLDER OR CONTRIBUTORS BE LIABLE FOR ANY DIRECT, INDIRECT, INCIDENTAL, SPECIAL, EXEMPLARY, OR CONSEQUENTIAL DAMAGES (INCLUDING, BUT NOT LIMITED TO, PROCUREMENT OF SUBSTITUTE GOODS OR SERVICES; LOSS OF USE, DATA, OR PROFITS; OR BUSINESS INTERRUPTION) HOWEVER CAUSED AND ON ANY THEORY OF LIABILITY, WHETHER IN CONTRACT, STRICT LIABILITY, OR TORT (INCLUDING NEGLIGENCE OR OTHERWISE) ARISING IN ANY WAY OUT OF THE USE OF THIS SOFTWARE, EVEN IF ADVISED OF THE POSSIBILITY OF SUCH DAMAGE.</p>
-----	---

## Appendix: Part Numbers

**Manufacturer:** Cambium Networks Inc.

**Address:** 3800 Golf Road #360, Rolling Meadows, IL 60008 USA.

**Importers:**

**Address:**

Adapter Caution: Adapter shall be installed near the equipment and shall be easily accessible.

The following tables provides accessories details for cnPilot Home Routers:

## Appendix: Part Numbers

The software may contain one or more items of Third-Party Software supplied by other third-party suppliers. The terms of this Agreement govern your use of any Third-Party Software license is included, in

which case your use of the unless a separate third-party software license is included, in which case your use of the third-party software will then be governed by the separate third-party license.

## Part Numbers for cnPilot r195P Home Router

Part Number	Description	AC Power Cord Part Number
PL-r195PUSA-US	Home and Small Business Wi-Fi Router and Voice Gateway, 802.11AC with Cambium power out, US	N000900L040A
PL-r195PEUA-EU	Home and Small Business Wi-Fi Router and Voice Gateway, 802.11AC with Cambium power out, EU	N000900L041A
PL-r195PEUA-RW	Home and Small Business Wi-Fi Router and Voice Gateway, 802.11AC with Cambium power out, RW	N000900L041A
PL-r195PNPA-RW	Home and Small Business Wi-Fi Router and Voice Gateway, 802.11AC with Cambium power out, RW	-
PL-r195PUKA-EU	Home and Small Business Wi-Fi Router and Voice Gateway, 802.11AC with Cambium power out, EU	N000900L045A
PL-r195PINA-RW	Home and Small Business Wi-Fi Router and Voice Gateway, 802.11AC with Cambium power out, RW	N000900L043A
PL-r195PANA-RW	Home and Small Business Wi-Fi Router and Voice Gateway, 802.11AC with Cambium power out, RW	N000900L042A
PL-r195PNTA-RW	Home and Small Business Wi-Fi Router and Voice Gateway, 802.11AC with Cambium power out, RW	N000900L044A
PL-r195PARA-RW	Home and Small Business Wi-Fi Router and Voice Gateway, 802.11AC with Cambium power out, RW	N000900L047A

## Part Numbers for cnPilot r195W Home Router

Part Number	Description	12V 1A Wall Adaptor
PL-R195WUSA-US	r195W US type A P/S, 802.11n/AC Dual Band 2x2 WLAN access point	XA-PS12V1XA-US
PL-R195WEUA-EU	r195W EU type C P/S, 802.11n/AC Dual Band 2x2 WLAN access point	XA-PS12V1XA-EU
PL-R195WNPA-RW	r195W No line cord, 802.11n/AC Dual Band 2x2 WLAN access point	-
PL-R195WUKA-EU	r195W UK type G P/S, 802.11n/AC Dual Band 2x2 WLAN access point	XA-PS12V1XA-UK
PL-R195WINA-RW	r195W India type D P/S, 802.11n/AC Dual Band 2x2 WLAN access point	XA-PS12V1XA-IN
PL-R195WANA-RW	r195W AUS/NZ type I P/S, 802.11n/AC Dual Band 2x2 WLAN access point	XA-PS12V1XA-AN

Part Number	Description	12V 1A Wall Adaptor
PL-R195WNTA-RW	r195W Brazil type N P/S, 802.11n/AC Dual Band 2x2 WLAN access point	XA-PS12V1XA-NT
PL-R195WARA-RW	r195W Argentina type I P/S 802.11n/AC Dual Band 2x2 WLAN access point	TBD

## Part Numbers for cnPilot r200, r200P Home Routers

Part Number	Description	12V 2A Wall Mount or 12V 3A Desktop Adaptor
C000000L024A	cnPilot r200 US, 802.11n single band 300Mbps WLAN Router with ATA	XA-PS2AWPGA-US
C000000L025A	cnPilot r200 EU, 802.11n single band 300Mbps WLAN Router with ATA	XA-PS2AWPGA-EU
C000000L037A	cnPilot r200 AUS, 802.11n single band 300Mbps WLAN Router with ATA	XA-PS3ADTA-WW
C000000L038A	cnPilot r200 India, 802.11n single band 300Mbps WLAN Router with ATA	XA-PS3ADTA-WW
C000000L039A	cnPilot r200 Brazil, 802.11n single band 300Mbps WLAN Router with ATA	XA-PS3ADTA-WW
PL-R200XUKA-WW	cnPilot r200 (UK cord) 802.11n single band WLAN Router with ATA	XA-PS3ADTA-WW
PL-R200XCNA-WW	cnPilot r200 (China cord) 802.11n single band WLAN Router with ATA	XA-PS3ADTA-WW
PL-R200XARA-WW	cnPilot r200 (Argentina cord) 802.11n single band WLAN Router with ATA	XA-PS3ADTA-WW

## Part Numbers for cnPilot R201, R201P Home Routers

Part Number	Description	12V 2A wall mount or 12V 3A Desktop Adaptor
C000000L029A	cnPilot r201 EU, 802.11ac dual band Gigabit WLAN Router with ATA	XA-PS2AWPGA-US
C000000L040A	cnPilot r201 AUS, 802.11ac dual band Gigabit WLAN Router with ATA	XA-PS2AWPGA-EU
C000000L041A	cnPilot r201 India, 802.11ac dual band Gigabit WLAN Router with ATA	XA-PS3ADTA-WW
C000000L042A	cnPilot r201 Brazil, 802.11ac dual band Gigabit WLAN Router with ATA	XA-PS3ADTA-WW

Part Number	Description	12V 2A wall mount or 12V 3A Desktop Adaptor
PL-R201XUKA-WW	cnPilot r201 (UK cord) 802.11ac dual band WLAN Router with ATA	XA-PS3ADTA-WW
PL-R201XCNA-WW	cnPilot r201 (China cord) 802.11ac Dual band WLAN Router with ATA	XA-PS3ADTA-WW
PL-R201XARA-WW	cnPilot r201 (Argentina cord) 802.11ac Dual band WLAN Router with ATA	XA-PS3ADTA-WW

## Part Numbers for r201W Home Router

Part Number	Description	12V 3A
C000000L032A	cnPilot r201W, India, 802.11ac dual band Gigabit WLAN Router with PoE	XA-PS3ADTA-WW

## Part Numbers for cnPilot r190W Home Router

Part Number	Description	5V/1A Wall Mount
PL-r190WUSA-WW	r190W US Cord, 802.11n 2.4 GHz WLAN router	XA-PS5V1XXA-US
PL-r190WEUA-WW	r190W EU Cord, 802.11n 2.4 GHz WLAN router	XA-PS5V1XXA-EU
PL-r190WUKA-WW	r190W UK Cord, 802.11n 2.4 GHz WLAN router	XA-PS5V1XXA-UK
PL-r190WINA-WW	r190W India Cord, 802.11n 2.4 GHz WLAN router	XA-PS5V1XXA-IN

## Part Numbers for cnPilot r190V Home Router

Part Number	Description	12V/ 1A Wall Mount
PL-r190VUSA-WW	r190V US Cord, 802.11n 2.4 GHZ WLAN router with built-in ATA HW	XA- PS12V1XA - US
PL-r190VEUA-WW	r190V EU Cord, 802.11n 2.4 GHZ WLAN router with built-in ATA HW	XA- PS12V1XA - EU
PL-r190VUKA-WW	r190V UK Cord, 802.11n 2.4 GHZ WLAN router with built-in ATA HW	XA- PS12V1XA - UK
PL-r190VINA-WW	r190V India Cord, 802.11n WLAN router with built-in ATA HW	XA- PS12V1XA - IN
PL-r190VANA-AN	r190V AUS/NZ Cord, 802.11n 2.4 GHZ WLAN router with built-in ATA HW	XA- PS12V1XA - AN

Hereby, Cambium Networks Inc. agrees that this device is in compliance with the essential requirements and other relevant provisions of Directive 2014/53/EU. A copy of the declaration of conformity can be obtained with this user manual.

This product is not restricted in the EU.

**Operation Temperature Range:** -5°C ~ +45°C

Frequency Range:

2.4 GHz: 2412MHz-2472MHz

5 GHz: 5180-5825 MHz

**Max power:** 20dBm

This equipment should be installed and operated with minimum distance 20 cm between the radiator.

## Glossary

Term	Definition
ATA	Advanced Technology Attachment
Address Resolution Protocol	Protocol defined in RFC 826 to allow a network element to correlate a host IP address to the Ethernet address of the host. See <a href="http://www.faqs.org/rfcs/rfc826.html">http://www.faqs.org/rfcs/rfc826.html</a> .
Bridge	Network element that uses the physical address (not the logical address) of another to pass data. The bridge passes the data to either the destination address, if found in the simple routing table, or to all network segments other than the one that transmitted the data. Modules are Layer 2 bridges except that, where NAT is enabled for an SM, the SM is a Layer 3 switch. Compare to Switch and Router, and see also NAT.
DES	Data Encryption Standard. An over-the-air link option that uses secret 56-bit keys and 8 parity bits. DES performs a series of bit permutations, substitutions, and recombination operations on blocks of data.
DHCP	Dynamic Host Configuration Protocol defined in RFC 2131. Protocol that enables a device to be assigned a new IP address and TCP/IP parameters, including a default gateway, whenever the device reboots. Thus DHCP reduces configuration time, conserves IP addresses, and allows modules to be moved to a different network within the system. See <a href="http://www.faqs.org/rfcs/rfc2131.html">http://www.faqs.org/rfcs/rfc2131.html</a> . See also Static IP Address Assignment.
DNS	Domain Name System, a system for naming computers and network services that is organized into a hierarchy of domains
File Transfer Protocol	Utility that transfers of files through TCP (Transport Control Protocol) between computing devices that do not operate on the same platform. Defined in RFC 959. See <a href="http://www.faqs.org/rfcs/rfc959.html">http://www.faqs.org/rfcs/rfc959.html</a> .
FTP	File Transfer Protocol defined in RFC 959. Utility that transfers of files through TCP (Transport Control Protocol) between computing devices that do not operate on the same platform. See <a href="http://www.faqs.org/rfcs/rfc959.html">http://www.faqs.org/rfcs/rfc959.html</a> .
FXS	Foreign Exchange Station means the wall jack or the interface to the telephone system which FXO devices can be connected to

Term	Definition
Gateway	A network point that acts as an entrance to another network.
GUI	Graphical user interface.
HTTP	Hypertext Transfer Protocol used to make the Internet resources available on the World Wide Web. Defined in RFC 2068. See <a href="http://www.faqs.org/rfcs/rfc2068.html">http://www.faqs.org/rfcs/rfc2068.html</a> .
HTTPS	Hypertext Transfer Protocol Secure (HTTPS)
ICMP	Internet Control Message Protocols defined in RFC 792, used to identify Internet Protocol (IP)-level problems and to allow IP links to be tested. See <a href="http://www.faqs.org/rfcs/rfc792.html">http://www.faqs.org/rfcs/rfc792.html</a> .
IGMP	The Internet Group Management Protocol (IGMP) is a communications protocol used by hosts and adjacent routers on IPv4/IPv6 networks to establish multicast group memberships.
IP	Internet Protocol defined in RFC 791. The Network Layer in the TCP/IP protocol stack. This protocol is applied to addressing, routing, and delivering, and re-assembling data packets into the Data Link layer of the protocol stack. See <a href="http://www.faqs.org/rfcs/rfc791.html">http://www.faqs.org/rfcs/rfc791.html</a> .
IP Address	32-bit binary number that identifies a network element by both network and host. See also Subnet Mask.
IPv4	Traditional version of Internet Protocol, which defines 32-bit fields for data transmission.
ISM	Industrial, Scientific, and Medical Equipment radio frequency band, in the 900-MHz, 2.4-GHz, and 5.8-GHz ranges.
L2TP over IPsec	Level 2 Tunneling Protocol over IP Security. One of several virtual private network (VPN) implementation schemes. Regardless of whether Subscriber Modules have the Network Address Translation feature (NAT) enabled, they support VPNs that are based on this protocol.
LED	Light-Emitting Diode
MAC Address	Media Access Control address. The hardware address that the factory assigns to the module for identification in the Data Link layer interface of the Open Systems Interconnection system. This address serves as an electronic serial number.
NAT	Network Address Translation defined in RFC 1631. A scheme that isolates Subscriber Modules from the Internet. See <a href="http://www.faqs.org/rfcs/rfc1631.html">http://www.faqs.org/rfcs/rfc1631.html</a> .
NEC	National Electrical Code. The set of national wiring standards that are enforced in the U.S.A.
NetBIOS	Protocol defined in RFC 1001 and RFC 1002 to support an applications programming interface in TCP/IP. This interface allows a computer to transmit and receive data with another host computer on the network. RFC 1001 defines the concepts and methods. RFC 1002 defines the detailed specifications. See <a href="http://www.faqs.org/rfcs/rfc1001.html">http://www.faqs.org/rfcs/rfc1001.html</a> and <a href="http://www.faqs.org/rfcs/rfc1002.html">http://www.faqs.org/rfcs/rfc1002.html</a> .
Network	Scheme that defines the Access Point Module as a proxy server to isolate registered

Term	Definition
Address Translation	Subscriber Modules from the Internet. Defined in RFC 1631. See <a href="http://www.faqs.org/rfcs/rfc1631.html">http://www.faqs.org/rfcs/rfc1631.html</a> .
Network Management Station	See NMS.
NMS	Network Management Station. A monitor device that uses Simple Network Management Protocol (SNMP) to control, gather, and report information about predefined network variables (objects). See also Simple Network Management Protocol.
NTP	Network Time Protocol (NTP) is a protocol that is used to synchronize computer clock times in a network of computers
PPPoE	Point to Point Protocol over Ethernet. Supported on SMs for operators who use PPPoE in other parts of their network operators who want to deploy PPPoE to realize per-subscriber authentication, metrics, and usage control.
QoS	Quality of Service (QoS) refers to the capability of a network to provide better service to selected network traffic over various technologies
RJ-45	Standard cable that is typically used for Ethernet connection. This cable may be wired as straight-through or as crossover. Later modules auto-sense whether the cable is straight-through or crossover.
Router	Network element that uses the logical (IP) address of another to pass data to only the intended recipient. Compare to Switch and Bridge.
SIP	Session Initiation Protocol
Simple Network Management Protocol	Standard that is used for communications between a program (agent) in the network and a network management station (monitor). Defined in RFC 1157. See <a href="http://www.faqs.org/rfcs/rfc1157.html">http://www.faqs.org/rfcs/rfc1157.html</a> .
SNMP	See Simple Network Management Protocol, defined in RFC 1157.
SNMPv3	SNMP version 3
Static IP Address Assignment	Assignment of Internet Protocol address that can be changed only manually. Thus static IP address assignment requires more configuration time and consumes more of the available IP addresses than DHCP address assignment does. RFC 2050 provides guidelines for the static allocation of IP addresses. See <a href="http://www.faqs.org/rfcs/rfc2050.html">http://www.faqs.org/rfcs/rfc2050.html</a> . See also DHCP.
SSID	Service Set Identifier
Subnet Mask	32-bit binary number that filters an IP address to reveal what part identifies the network and what part identifies the host. The number of subnet mask bits that are set to 1 indicates how many leading bits of the IP address identify the network. The number of subnet mask bits that are set 0 indicate how many trailing bits of the IP address identify the host.



Term	Definition
Switch	Network element that uses the port that is associated with the physical address of another to pass data to only the intended recipient. Compare to Bridge and Router.
TCP	Alternatively known as Transmission Control Protocol or Transport Control Protocol. The Transport Layer in the TCP/IP protocol stack. This protocol is applied to assure that data packets arrive at the target network element and to control the flow of data through the Internet. Defined in RFC 793. See <a href="http://www.faqs.org/rfcs/rfc793.html">http://www.faqs.org/rfcs/rfc793.html</a> .
TFTP	Trivial File Transfer Protocol is a simple high-level protocol for transferring data servers.
TKIP	Temporal Key Integrity Protocol
TR 069	TR-069 (Technical Report 069) is a technical specification that defines an application layer protocol for remote management of end-user devices.
VLAN	Virtual local area network. An association of devices through software that contains broadcast traffic, as routers would, but in the switch-level protocol.
UPnP	Universal Plug and Play
USB	Universal Serial Bus
WDS	Wireless Distribution System
WLAN	Wireless Local Area Network
WMM	Wi-Fi Multimedia
WPA2-PSK	Wi-Fi Protected Access 2 - Pre-Shared Key, and also called WPA or WPA2 Personal, it is a method of securing your network using WPA2 with the use of the optional Pre-Shared Key (PSK) authentication, which was designed for home users without an enterprise authentication server.
WPS	Wi-Fi Protected Setup